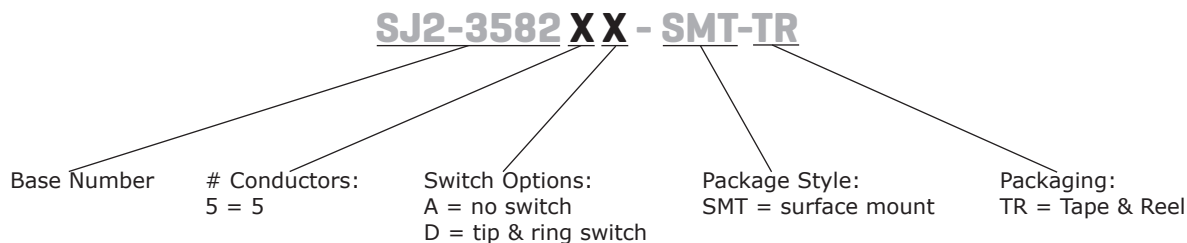

SERIES: SJ2-3582X-SMT | **DESCRIPTION:** AUDIO JACK**FEATURES**

- 5 conductor
- right angle
- reflow solder compatible
- surface mount

**PART NUMBER KEY****SPECIFICATIONS**

| parameter | conditions/description | min | typ | max | units |
|---------------------------------|--|-----|-------|----------|----------|
| rated input voltage | | | 12 | | Vdc |
| rated input current | | | | 1 | A |
| contact resistance ¹ | between terminal and mating plug between terminal in a closed circuit | | | 50 30 | mΩ mΩ |
| insulation resistance | at 500 Vdc | 100 | | | MΩ |
| voltage withstand | for 1 minute | | | 500 | Vac |
| insertion/withdrawal force | | 0.3 | | 3 | kg |
| operating temperature | | -25 | | 85 | °C |
| life | at a rate of 24 cycles/minute | | 5,000 | | cycles |
| flammability rating | UL94V-0 | | | | |
| RoHS | yes | | | | |

Note: 1. When measured at a current of less than 100 mA/1 kHz
2. All specifications measured at 10~35°C, humidity at 45~85%, under standard atmospheric pressure, unless otherwise noted.

MECHANICAL DRAWING

units: mm
 tolerance:
 X.X ±0.2 mm
 X.XX ±0.10 mm
 X.XXX ±0.050 mm
 PCB: ±0.05 mm

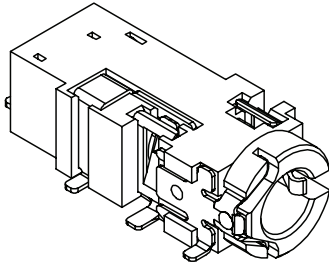

| | MATERIAL | PLATING |
|-------------|--------------|---------|
| terminal 1 | copper alloy | silver |
| terminal 2 | copper alloy | silver |
| terminal 3 | copper alloy | silver |
| terminal 4 | copper alloy | silver |
| terminal 5 | copper alloy | silver |
| terminal 10 | brass | silver |
| terminal 11 | brass | silver |
| plastic | PA10T | |

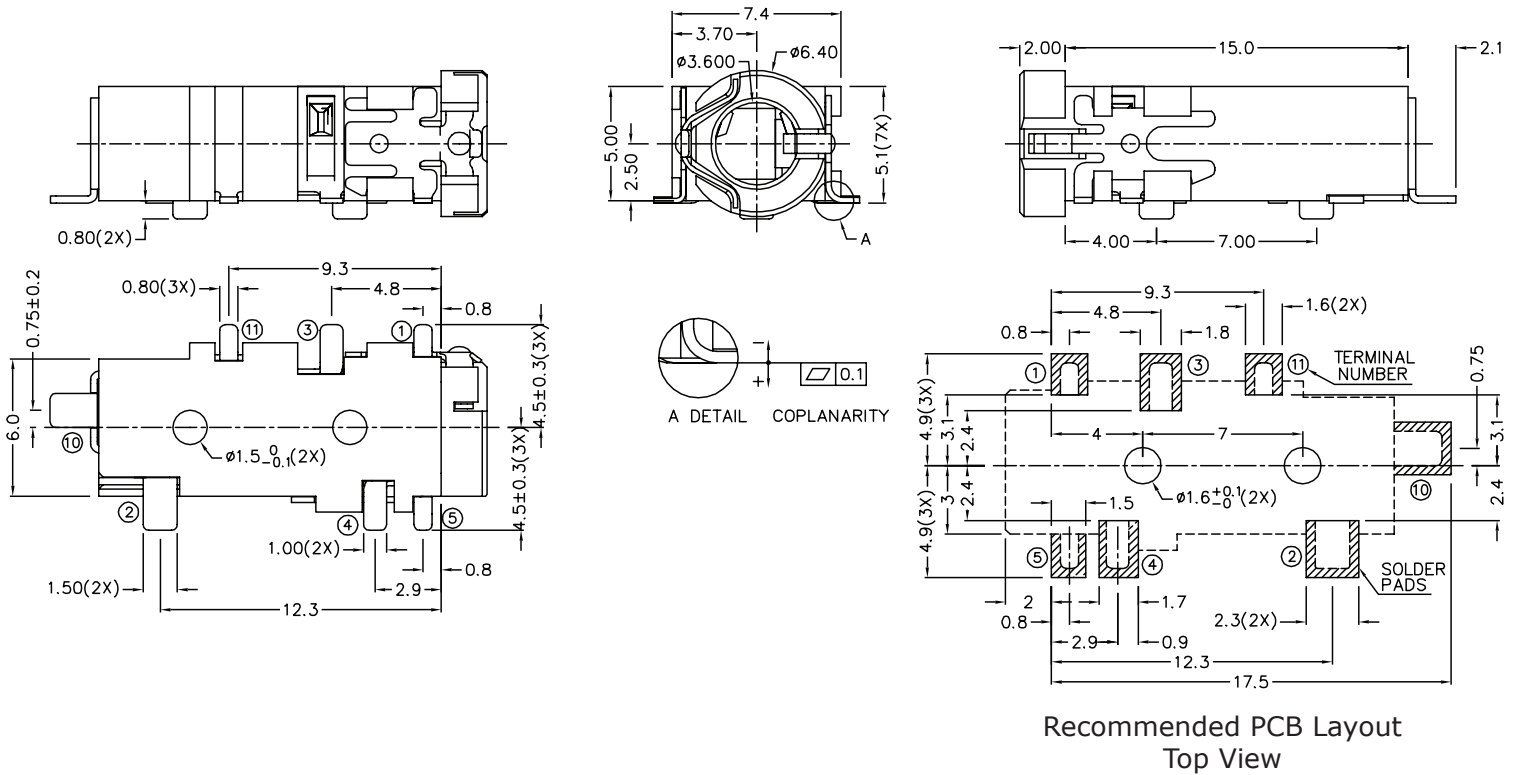

Recommended PCB Layout
Top View

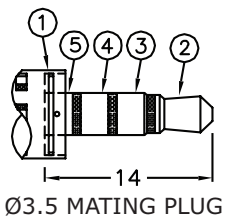

| Model No. | SJ2-35825A-SMT | SJ2-35825D-SMT |
|-----------|----------------|----------------|
| Schematic | | |
| PIN | | |
| 1 | outer ring | outer ring |
| 2 | tip | tip |
| 3 | ring 1 | ring 1 |
| 4 | ring 2 | ring 2 |
| 5 | sleeve | sleeve |
| 10 | NP | tip switch |
| 11 | NP | ring 1 switch |

SOLDERABILITY

| parameter | conditions/description | min | typ | max | units |
|--------------------------------|--|-----|-----|-----|-------|
| reel storage | at relative humidity <80% | | | 40 | °C |
| reflow soldering ¹ | see reflow profile | 255 | 260 | 265 | °C |
| drying conditions ² | parts in reel: bake at 40°C ±5°C for 72 hours parts removed from reel: bake at 40°C ±5°C for 10 hours | | | | |

Note: 1. Must reflow solder within 72 hours from opening vacuum packaging at a temperature <30°C & relative humidity <60%.
2. When exceeding floor life by >72 hours.



PACKAGING

units: mm

Reel Size: Ø381 mm
Reel QTY: 850 pcs per reel

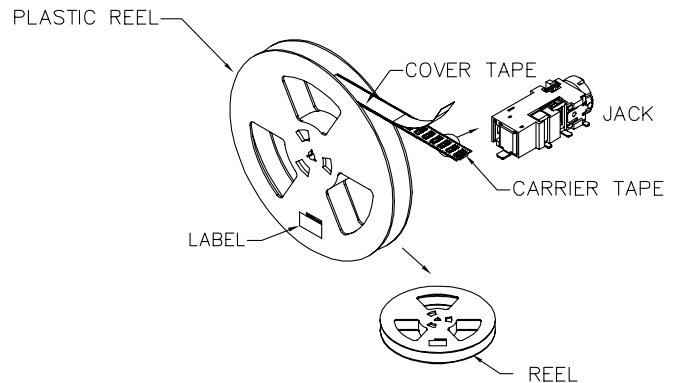
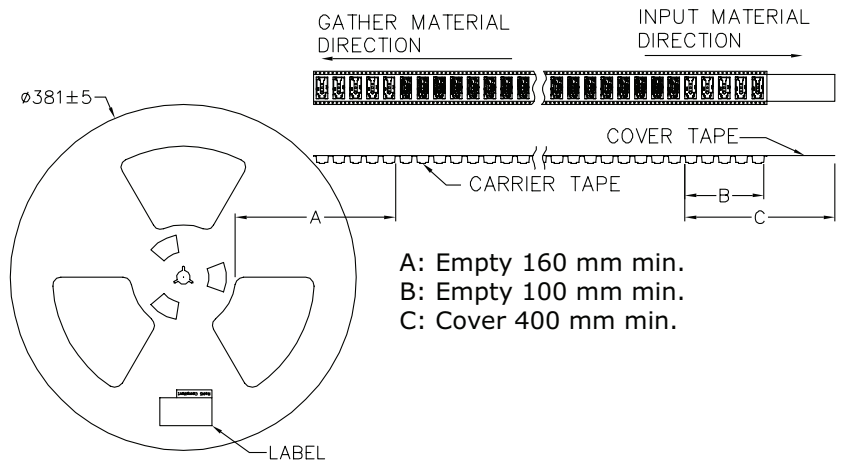
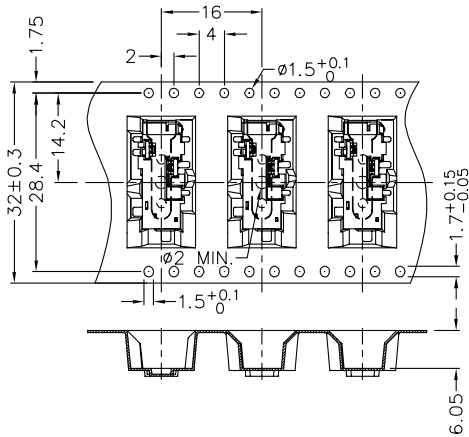

REVISION HISTORY

| rev. | description | date |
|------|-------------------------------------|------------|
| 1.0 | initial release | 12/12/2016 |
| 1.01 | added storage and drying conditions | 06/09/2017 |
| 1.02 | brand update | 10/10/2019 |

The revision history provided is for informational purposes only and is believed to be accurate.

CUI DEVICES

CUI Devices offers a one (1) year limited warranty. Complete warranty information is listed on our website.

CUI Devices reserves the right to make changes to the product at any time without notice. Information provided by CUI Devices is believed to be accurate and reliable. However, no responsibility is assumed by CUI Devices for its use, nor for any infringements of patents or other rights of third parties which may result from its use.

CUI Devices products are not authorized or warranted for use as critical components in equipment that requires an extremely high level of reliability. A critical component is any component of a life support device or system whose failure to perform can be reasonably expected to cause the failure of the life support device or system, or to affect its safety or effectiveness.

Компания «Life Electronics» занимается поставками электронных компонентов импортного и отечественного производства от производителей и со складов крупных дистрибьюторов Европы, Америки и Азии.

С конца 2013 года компания активно расширяет линейку поставок компонентов по направлению коаксиальный кабель, кварцевые генераторы и конденсаторы (керамические, пленочные, электролитические), за счёт заключения дистрибьюторских договоров

Мы предлагаем:

- Конкурентоспособные цены и скидки постоянным клиентам.
- Специальные условия для постоянных клиентов.
- Подбор аналогов.
- Поставку компонентов в любых объемах, удовлетворяющих вашим потребностям.
- Приемлемые сроки поставки, возможна ускоренная поставка.
- Доставку товара в любую точку России и стран СНГ.
- Комплексную поставку.
- Работу по проектам и поставку образцов.
- Формирование склада под заказчика.
- Сертификаты соответствия на поставляемую продукцию (по желанию клиента).
- Тестирование поставляемой продукции.
- Поставку компонентов, требующих военную и космическую приемку.
- Входной контроль качества.
- Наличие сертификата ISO.

В составе нашей компании организован Конструкторский отдел, призванный помогать разработчикам, и инженерам.

Конструкторский отдел помогает осуществить:

- Регистрацию проекта у производителя компонентов.
- Техническую поддержку проекта.
- Защиту от снятия компонента с производства.
- Оценку стоимости проекта по компонентам.
- Изготовление тестовой платы монтаж и пусконаладочные работы.



Тел: +7 (812) 336 43 04 (многоканальный)
Email: org@lifeelectronics.ru