

## MAX44285

## Dual-Channel, High-Precision, High-Voltage, Current-Sense Amplifier

### General Description

The MAX44285 dual-channel high-side current-sense amplifier has precision accuracy specifications of  $V_{OS}$  less than  $12\mu\text{V}$  (max) and gain error less than 0.1% (max).

The MAX44285 features an input common-mode voltage range from 2.7V to 76V with 80kHz of small-signal bandwidth, which makes it ideal for interfacing with a SAR ADC for multichannel multiplexed data acquisition systems.

The MAX44285 operates over the  $-40^{\circ}\text{C}$  to  $+125^{\circ}\text{C}$  temperature range. The MAX44285 is offered in 8-bump WLP and 8-pin  $\mu\text{MAX}^{\text{®}}$  packages.

### Applications

- Base Stations and Communication Equipment
- Power Management Systems
- Server Backplanes
- Industrial Control and Automation

### Benefits and Features

- 2.7V to 76V Input Common Mode
- Low  $12\mu\text{V}$  (max) Input Offset Voltage
- Low 0.1% (max) Gain Error
- Gain Options
  - $G = 12.5\text{V/V}$  (MAX44285L)
  - $G = 20\text{V/V}$  (MAX44285T)
  - $G = 50\text{V/V}$  (MAX44285F)
  - $G = 100\text{V/V}$  (MAX44285H)
- 1mm x 2mm 8-Bump WLP and 8-Pin  $\mu\text{MAX}$  Packages

*$\mu\text{MAX}$  is a registered trademark of Maxim Integrated Products, Inc.*

### Typical Operating Circuit

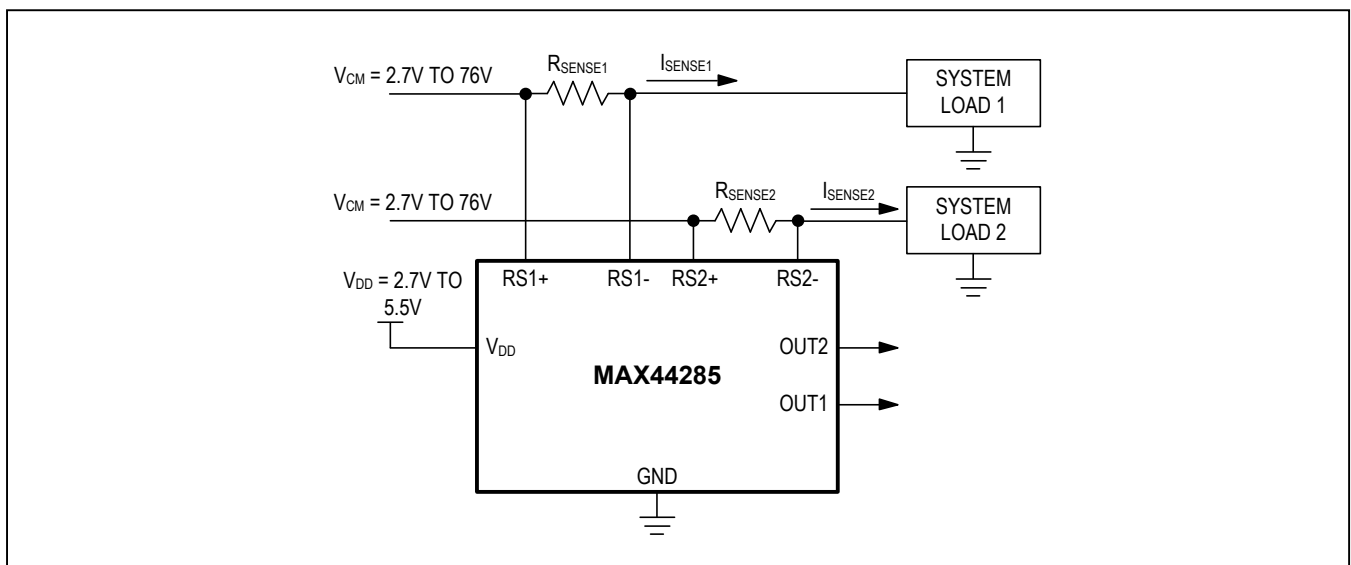

For related parts and recommended products to use with this part, refer to [www.maximintegrated.com/MAX44285.related](http://www.maximintegrated.com/MAX44285.related).

[Ordering Information](#) appears at end of data sheet.

**Absolute Maximum Ratings**

V <sub>DD</sub> to GND .....	-0.3V to +6.0V	Continuous Power Dissipation (T <sub>A</sub> = +70°C)
RS+, RS- to GND .....	-0.3V to +80V	WLP (derate 13.3mW/°C above +70°C) .....
RS+ to RS-		μMAX (derate 4.8mW/°C above +70°C) .....
μMAX (1s maximum duration due to package thermal dissipation).....	±80V	Operating Temperature Range .....
WLP (1s maximum duration due to package thermal dissipation).....	±50V	Junction Temperature .....
Continuous Input Current (Any Pin) .....	±20mA	Storage Temperature Range .....
		Lead Temperature (soldering, 10s)(μMAX only) .....
		Soldering Temperature (reflow) .....

Stresses beyond those listed under "Absolute Maximum Ratings" may cause permanent damage to the device. These are stress ratings only, and functional operation of the device at these or any other conditions beyond those indicated in the operational sections of the specifications is not implied. Exposure to absolute maximum rating conditions for extended periods may affect device reliability.

**Package Thermal Characteristics (Note 1)**

WLP		μMAX
Junction-to-Ambient Thermal Resistance (θ <sub>JA</sub> ) .....	75°C/W	Junction-to-Ambient Thermal Resistance (θ <sub>JA</sub> ) .....
		Junction-to-Case Thermal Resistance (θ <sub>JC</sub> ) .....

**Note 1:** Package thermal resistances were obtained using the method described in JEDEC specification JESD51-7, using a four-layer board. For detailed information on package thermal considerations, refer to [www.maximintegrated.com/thermal-tutorial](http://www.maximintegrated.com/thermal-tutorial).

**Electrical Characteristics**

(V<sub>RS+</sub> = V<sub>RS-</sub> = +76V, V<sub>DD</sub> = +3.3V, V<sub>SENSE</sub> = V<sub>RS+</sub> - V<sub>RS-</sub> = 1mV, T<sub>A</sub> = -40°C to +125°C, unless otherwise noted. Typical values are at T<sub>A</sub> = +25°C.) (Note 2)

PARAMETER	SYMBOL	CONDITIONS	MIN	TYP	MAX	UNITS
<b>DC CHARACTERISTICS</b>						
Supply Voltage	V <sub>DD</sub>	Guaranteed by PSRR	2.7		5.5	V
Supply Current	I <sub>DD</sub>	T <sub>A</sub> = +25°C			1300	μA
		-40°C < T <sub>A</sub> < +125°C			1500	
Power-Supply Rejection Ratio	PSRR	2.7V ≤ V <sub>DD</sub> ≤ 5.5V	110	120		dB
Input Common-Mode Voltage Range	V <sub>CM</sub>	Guaranteed by CMRR	2.7		76	V
Input Bias Current at V <sub>RS+</sub> and V <sub>RS-</sub> (Note 3)	I <sub>RS+</sub> , I <sub>RS-</sub>				65	μA
Input Offset Current (Note 3)	I <sub>RS+</sub> - I <sub>RS-</sub>				1100	nA
Input Leakage Current (Note 3)	I <sub>RS+</sub> , I <sub>RS-</sub>	V <sub>DD</sub> = 0V, V <sub>RS+</sub> = 76V			6	μA
Common-Mode Rejection Ratio	CMRR	4.5V < V <sub>RS+</sub> < 76V	125	140		dB
Input Offset Voltage (Note 3)	V <sub>OS</sub>	T <sub>A</sub> = +25°C			±12	μV
		-40°C ≤ T <sub>A</sub> ≤ +125°C			±25	
Input Offset Voltage Drift (Note 3)	TCV <sub>OS</sub>				130	nV/°C

**Electrical Characteristics (continued)**

( $V_{RS+} = V_{RS-} = +76V$ ,  $V_{DD} = +3.3V$ ,  $V_{SENSE} = V_{RS+} - V_{RS-} = 1mV$ ,  $T_A = -40^{\circ}C$  to  $+125^{\circ}C$ , unless otherwise noted. Typical values are at  $T_A = +25^{\circ}C$ .) (Note 2)

PARAMETER	SYMBOL	CONDITIONS	MIN	TYP	MAX	UNITS
Input Sense Voltage	$V_{SENSE}$	MAX44285L (G = 12.5V/V)		200		mV
		MAX44285T (G = 20V/V)		125		
		MAX44285F (G = 50V/V)		50		
		MAX44285H (G = 100V/V)		25		
Gain (Note 4)	G	Full-scale $V_{SENSE} = 200mV$		12.5		V/V
		Full-scale $V_{SENSE} = 125mV$		20		
		Full-scale $V_{SENSE} = 50mV$		50		
		Full-scale $V_{SENSE} = 25mV$		100		
Gain Error (Note 3)	GE	$T_A = +25^{\circ}C$			0.1	%
		$-40^{\circ}C \leq T_A \leq +85^{\circ}C$			0.3	
		$-40^{\circ}C \leq T_A \leq +125^{\circ}C$			0.5	
Output Resistance	$R_{OUT}$			0.1		m $\Omega$
Output Low Voltage	$V_{OL}$	Sink 500 $\mu$ A			15	mV
		No load			4	
Output High Voltage	$V_{OH}$	Source 500 $\mu$ A	$V_{DD} - 0.015$			V
<b>AC CHARACTERISTICS</b>						
Signal Bandwidth	BW -3dB	All gain configurations $V_{SENSE} > 5mV$		80		kHz
AC Power-Supply Rejection Ratio	AC PSRR	f = 200kHz		40		dB
AC CMRR	AC CMRR	f = 200kHz	1mV sine wave	54		dB
			20mV sine wave	47		
Output Transient Recovery Time		$\Delta V_{OUT} = 2V_{P-P}$ , 14-bit settling with 400 $\Omega$ and 1nF, 6nF ADC sampling capacitor		2		$\mu$ s
Capacitive Load Stability	$C_{LOAD}$	With 250 $\Omega$ isolation resistor		20		nF
		Without any isolation resistor		200		pF
Input Voltage-Noise Density	$e_n$	f = 1kHz		45		nV/ $\sqrt{Hz}$
Total Harmonic Distortion (Up to 7th Harmonics)	THD	f = 1kHz, $V_{OUT} = 1V_{P-P}$		63		dB
Power-Up Time (Note 5)				200		$\mu$ s
Saturation Recovery Time				10		$\mu$ s

**Note 2:** All devices are 100% production tested at  $T_A = +25^{\circ}C$ . All temperature limits are guaranteed by design.

**Note 3:** Specifications are guaranteed by design, not production tested.

**Note 4:** Gain and offset voltage are calculated based on two point measurements:  $V_{SENSE1}$  and  $V_{SENSE2}$ .

$V_{SENSE1} = 20\% \times \text{Full Scale } V_{SENSE}$ .  $V_{SENSE2} = 80\% \times \text{Full Scale } V_{SENSE}$ .

**Note 5:** Output is high-Z during power-up.

Typical Operating Characteristics

( $V_{RS+} = V_{RS-} = 76V$ ,  $V_{DD} = 3.3V$ ,  $V_{SENSE} = V_{RS+} - V_{RS-} = 1mV$ ,  $T_A = +25^{\circ}C$ , unless otherwise noted.) (Note 2)

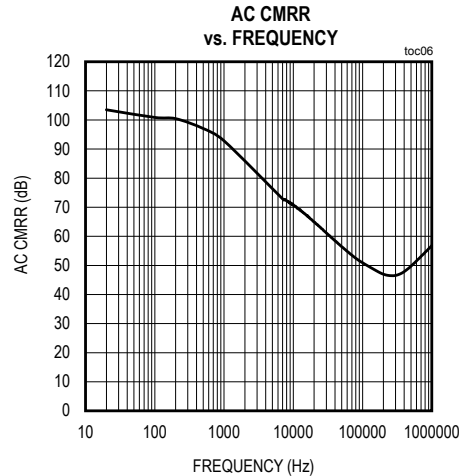
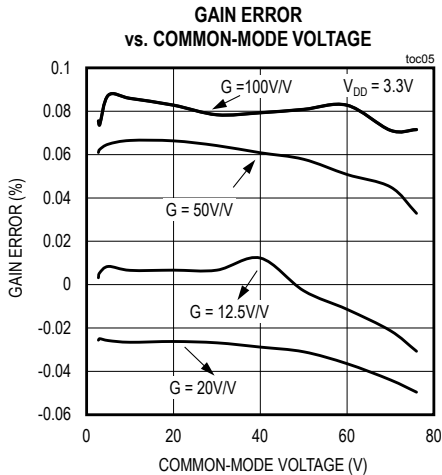
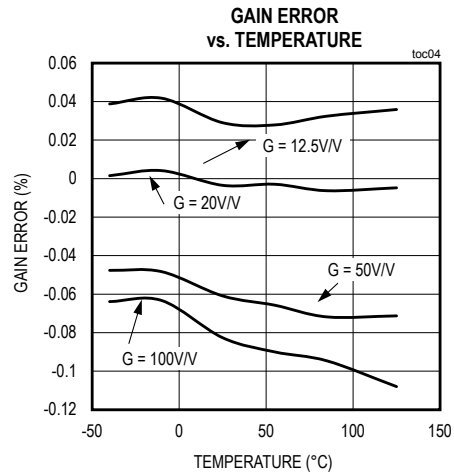
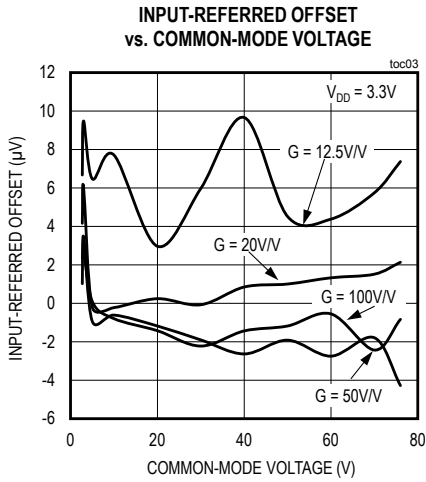
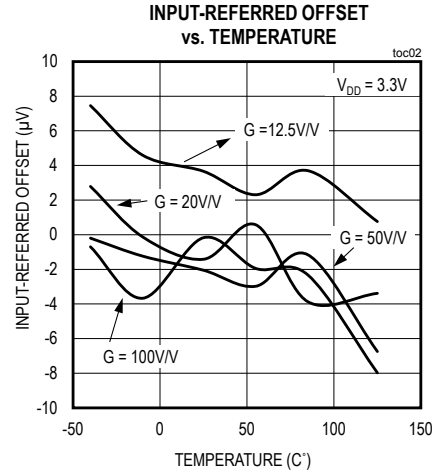
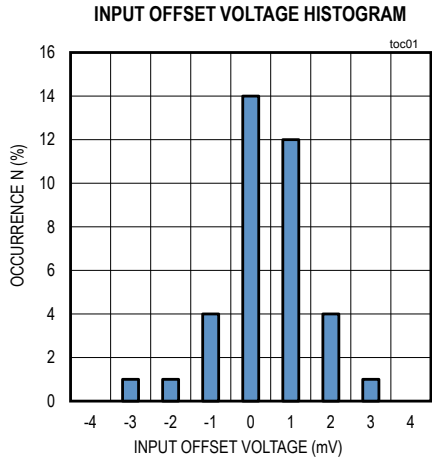

Typical Operating Characteristics (continued)

( $V_{RS+} = V_{RS-} = 76V$ ,  $V_{DD} = 3.3V$ ,  $V_{SENSE} = V_{RS+} - V_{RS-} = 1mV$ ,  $T_A = +25^{\circ}C$ , unless otherwise noted.) (Note 2)

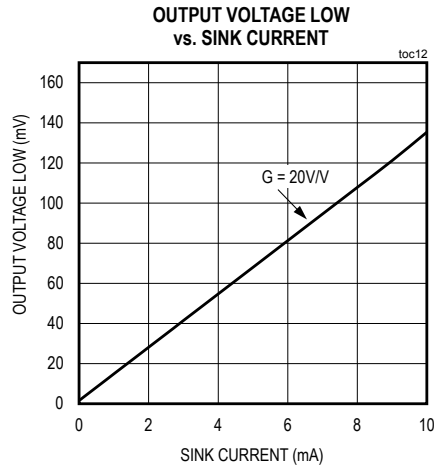
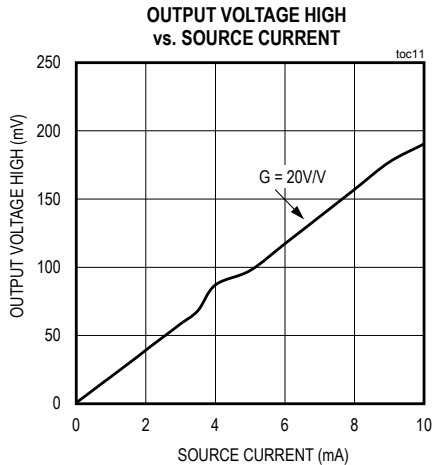
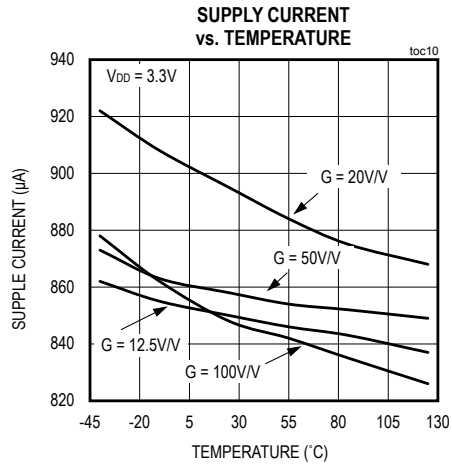
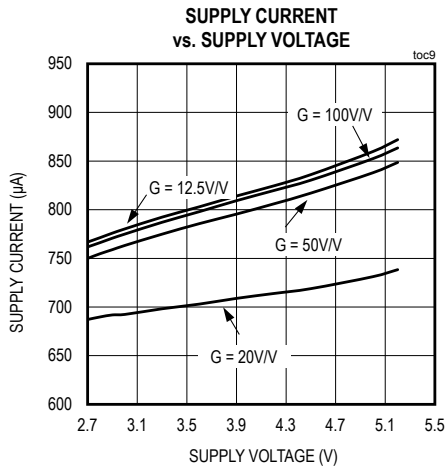
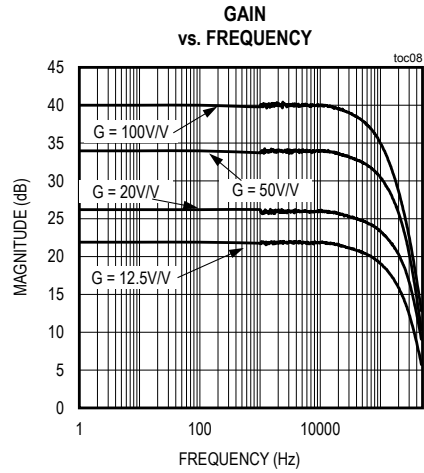
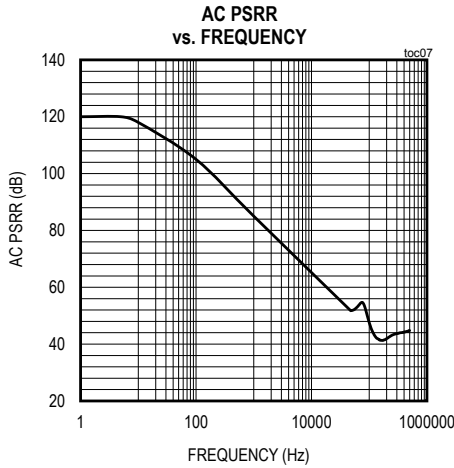

Typical Operating Characteristics (continued)

( $V_{RS+} = V_{RS-} = 76V$ ,  $V_{DD} = 3.3V$ ,  $V_{SENSE} = V_{RS+} - V_{RS-} = 1mV$ ,  $T_A = +25^{\circ}C$ , unless otherwise noted.) (Note 2)

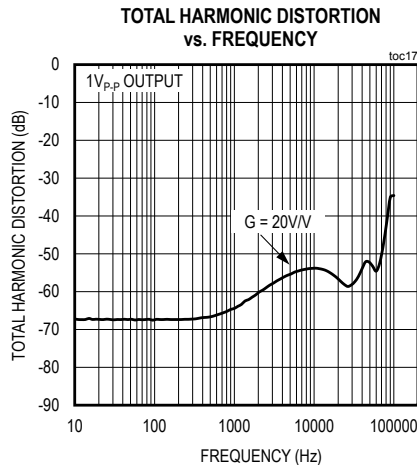
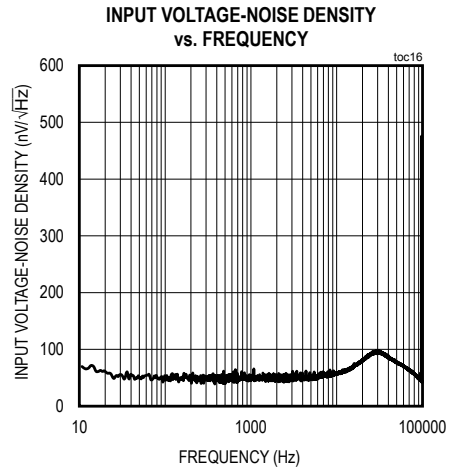
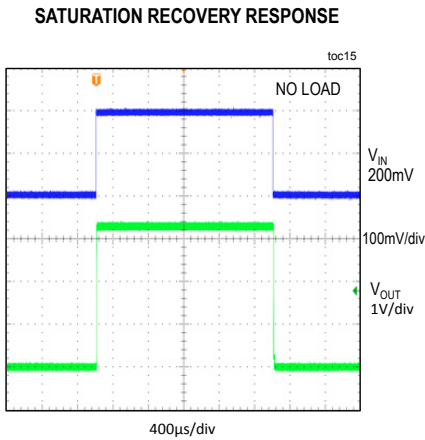
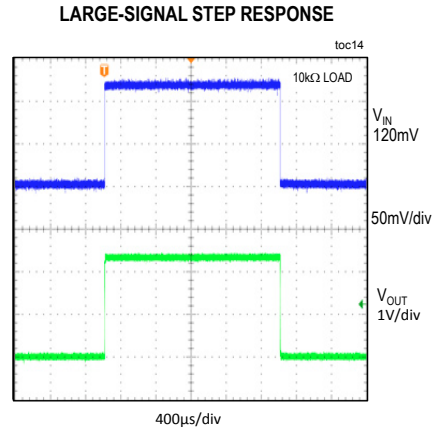
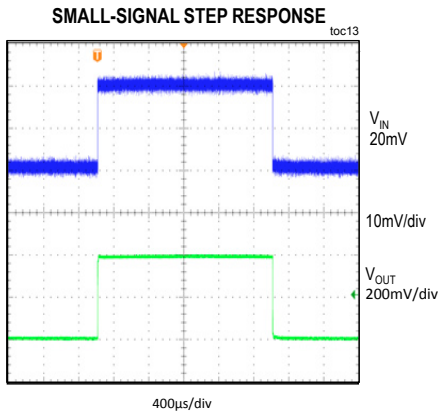

Pin Configuration

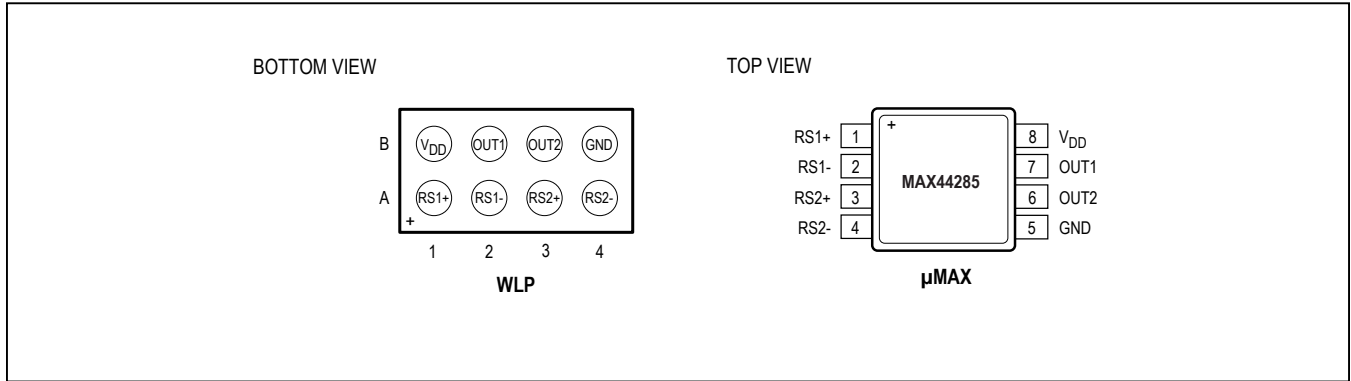

Pin Description

PIN		NAME	FUNCTION
WLP	µMAX		
A1	1	RS1+	Channel 1 External Resistor Power-Side Connection
A2	2	RS1-	Channel 1 External Resistor Load-Side Connection
A3	3	RS2+	Channel 2 External Resistor Power-Side Connection
A4	4	RS2-	Channel 2 External Resistor Load-Side Connection
B1	8	V <sub>DD</sub>	Supply Voltage
B2	7	OUT1	Output Channel 1
B3	6	OUT2	Output Channel 2
B4	5	GND	Ground

Functional Diagram

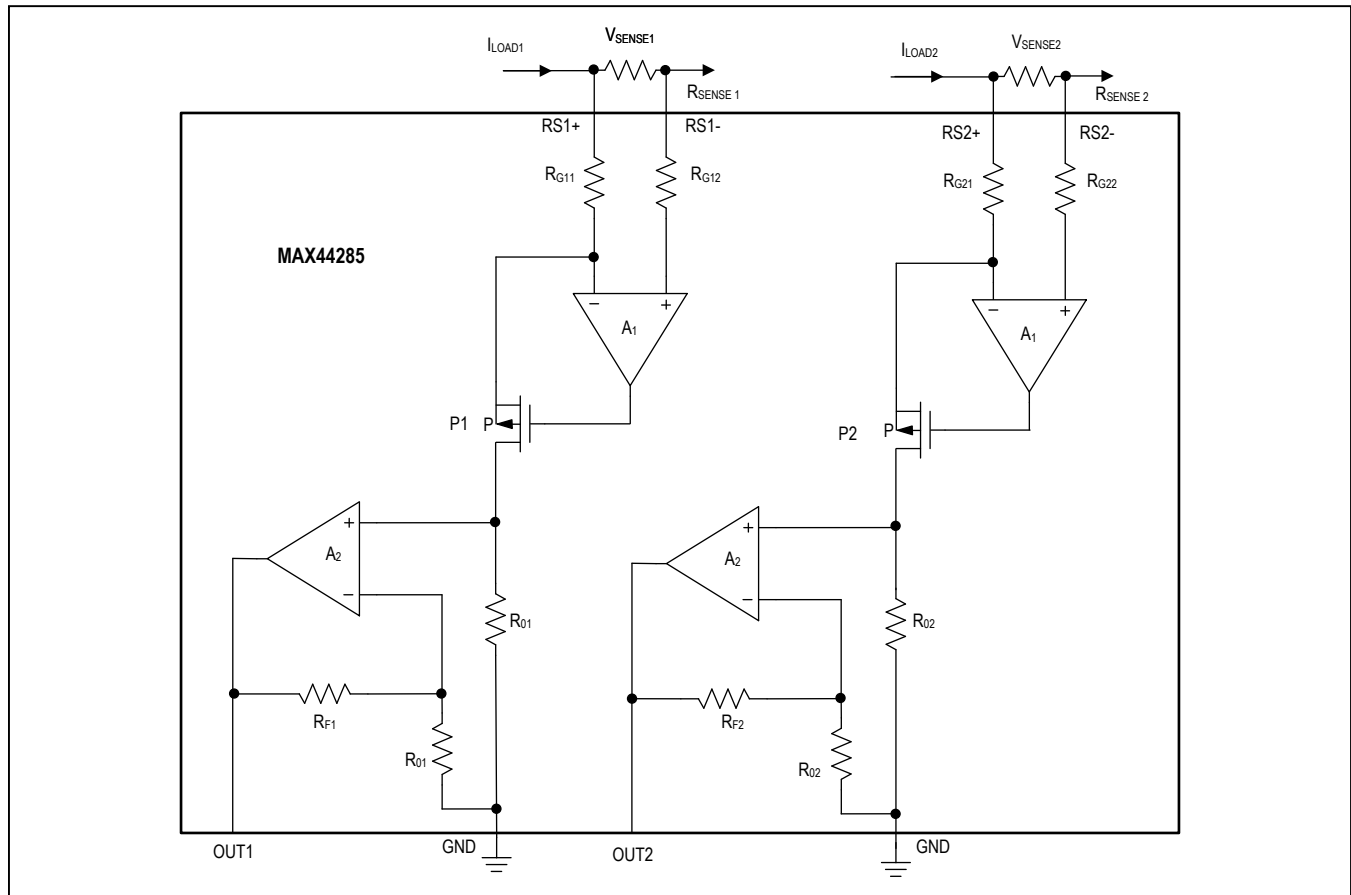

Detailed Description

The MAX44285 high-side, current-sense amplifier features a 2.7V to 76V input common-mode range that is independent of supply voltage. This feature allows the monitoring of current out of a battery as low as 2.7V and enables high-side current sensing at voltages greater than the supply voltage ( $V_{DD}$ ). The MAX44285 monitors current through a current-sense resistor and amplifies the voltage across the resistor.

High-side current monitoring does not interfere with the ground path of the load being measured, making the MAX44285 particularly useful in a wide range of high-voltage systems.

The MAX44285 operates as follows: current from the source flows through  $R_{SENSE}$  to the load (see [Functional Diagram](#)), creating a sense voltage,  $V_{SENSE}$ . The internal op amp A1 is used to force the current through an internal gain resistor  $R_{G11}$  at RS1+ pin, such that its voltage drop

equals the voltage drop ( $V_{SENSE}$ ) across the external sense resistor ( $R_{SENSE}$ ). The internal resistor at RS1- pin ( $R_{G12}$ ) has the same value as  $R_{G11}$  to minimize error. The current through  $R_{G11}$  is sourced by a high-voltage p-channel p-FET. Its source current is the same as the drain current which flows through a second gain resistor,  $R_{01}$ , producing a voltage  $V_{R01} = V_{SENSE} \times R_{01}/R_{G11}$ .

The output voltage  $V_{OUT1}$  is produced from a second op amp A2 with the gain  $(1 + R_{F1}/R_{01})$ . Hence, the  $V_{OUT1} = I_{LOAD1} \times R_{SENSE1} (R_{01}/R_{G11}) \times (1 + R_{F1}/R_{01})$  for channel 1 and  $V_{OUT2} = I_{LOAD2} \times R_{SENSE2} (R_{02}/R_{G21}) \times (1 + R_{F2}/R_{02})$  for channel 2. Internal resistor  $R_{01} = R_{02}$ ,  $R_{G11} = R_{G12} = R_{G21} = R_{G22}$ ,  $R_{F1} = R_{F2}$ . The gain-setting resistors  $R_{01}$ ,  $R_{02}$ ,  $R_{G11}$ ,  $R_{G12}$ ,  $R_{G21}$ ,  $R_{G22}$ ,  $R_{F1}$ , and  $R_{F2}$  are available in Table 1):

Total gain = 12.5V/V for MAX44285L, 20V/V for the MAX44285T, 50V/V for the MAX44285F, and 100V/V for the MAX44285H.



**Table 1. Gain-Setting Resistors**

	GAIN (V/V)	R <sub>01</sub> , R <sub>02</sub> (kΩ)	R <sub>G11</sub> , R <sub>G12</sub> , R <sub>G21</sub> , R <sub>G22</sub> (kΩ)	R <sub>F1</sub> , R <sub>F2</sub> (kΩ)
MAX44285L	12.5	25	10	100
MAX44285T	20	25	10	175
MAX44285F	50	25	10	475
MAX44285H	100	25	10	975

## Applications Information

### Recommended Component Values

Ideally, the maximum load current develops the full-scale sense voltage across the current-sense resistor. Choose the gain needed to yield the maximum output voltage required for the application:

$$V_{OUT} = V_{SENSE} \times A_V$$

where  $V_{SENSE}$  is the full-scale sense voltage, 200mV for gain of 12.5V/V, 125mV for gain of 20V/V, 50mV for gain of 50V/V, 25mV for gain of 100V/V, and  $A_V$  is the gain of the device.

In applications monitoring a high current, ensure that  $R_{SENSE}$  is able to dissipate its own  $I^2R$  loss. If the resistor's power dissipation exceeds the nominal value, its value may drift or it may fail altogether. The MAX44285 senses a wide variety of currents with different sense-resistor values.

### Choosing the Sense Resistor

Choose  $R_{SENSE}$  based on the following criteria:

**Voltage Loss:** A high  $R_{SENSE}$  value causes the power-source voltage to degrade through IR loss. For minimal voltage loss, use the lowest  $R_{SENSE}$  value.

**Accuracy:** A high  $R_{SENSE}$  value allows lower currents measured more accurately. This is due to offsets becoming less significant when the sense voltage is larger. For best performance, select  $R_{SENSE}$  to provide approximately 200mV (gain of 12.5V/V), 125mV (gain of 20V/V), or 50mV (gain of 50V/V), 25mV (gain of 100V/V) of sense voltage for the full-scale current in each application.

**Efficiency and Power Dissipation:** At high current levels, the  $I^2R$  losses in  $R_{SENSE}$  can be significant. Consider this when choosing the resistor value and its power dissipation (wattage) rating. In addition, the sense resistor's value might drift if it heats up excessively.

**Inductance:** Keep inductance low if  $I_{SENSE}$  has a large high-frequency component. Wire-wound resistors have the highest inductance, while metal film is somewhat better. Low-inductance, metal-film resistors are also available. Instead of being spiral wrapped around a core, as in metal-film or wire wound resistors, they are a straight band of metal and are available in values under 1Ω.

Take care to eliminate parasitic trace resistance from causing errors in the sense voltage because of the high currents that flow through  $R_{SENSE}$ . Either use a four terminal current-sense resistor or use Kelvin (force and sense) PCB layout techniques.

### Base Station Application Circuit

An example of a typical application ([Figure 1](#)) of this high-voltage, high-precision current-sense amplifier is in base-station systems where there is a need to monitor the current flowing in the power amplifier. Such amplifiers, depending on the technology, can be biased up to 50V or 60V thus requiring a current-sense amplifier like the MAX44285 with high-voltage common mode. The very low input offset voltage of the MAX44285 minimizes the value of the external sense resistor thus resulting in system power-saving.

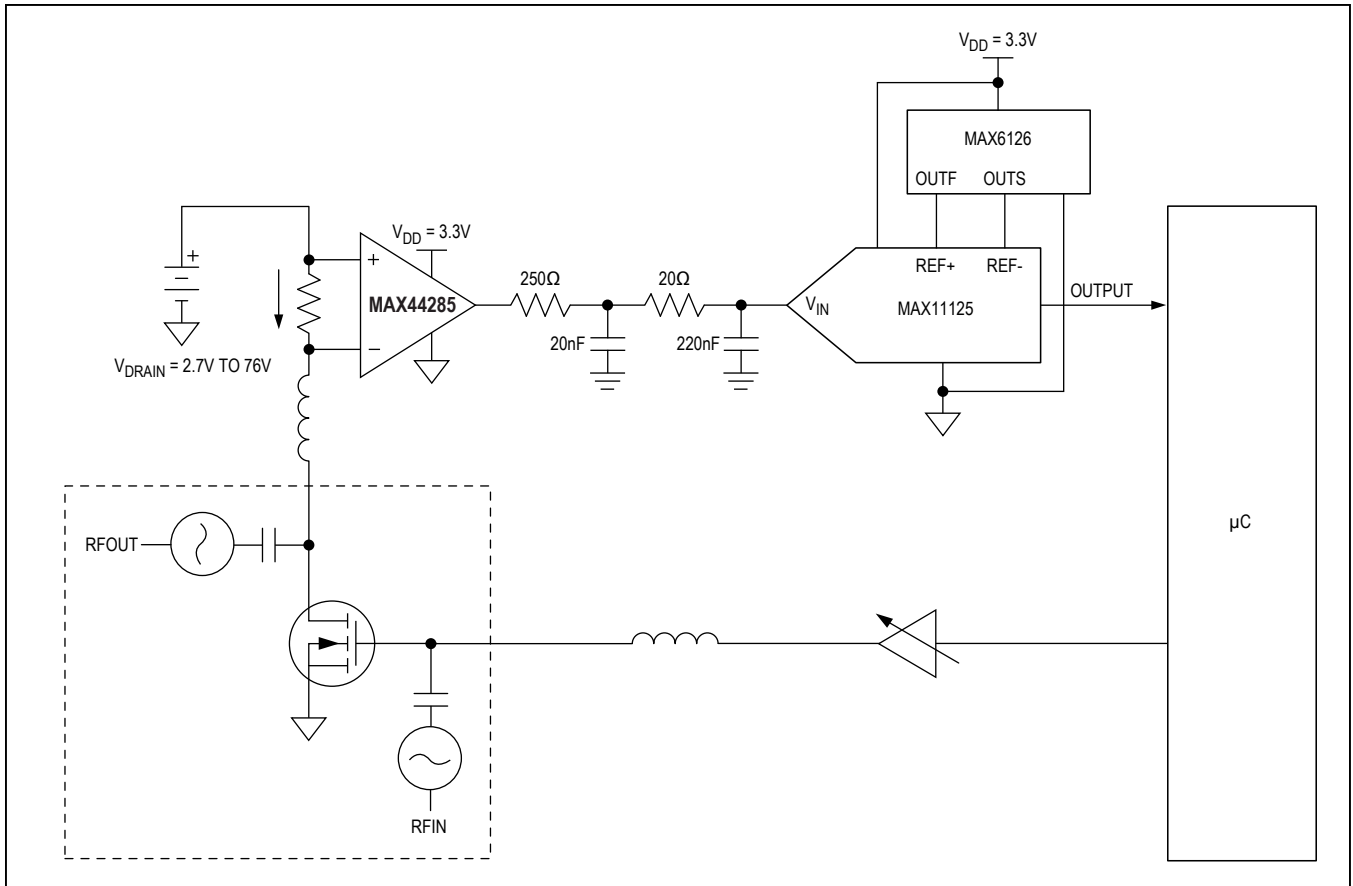

Figure 1. MAX44285 Used in Base-Station Application

## Ordering Information

PART	GAIN (V/V)	TEMP RANGE	PIN-PACKAGE	TOP MARK
MAX44285LAWA+	12.5	-40°C to +125°C	8 WLP	+AAF
MAX44285LAUA+	12.5	-40°C to +125°C	8 $\mu$ MAX	—
MAX44285TAWA+	20	-40°C to +125°C	8 WLP	+AAG
MAX44285TAUA+	20	-40°C to +125°C	8 $\mu$ MAX	—
MAX44285FAWA+	50	-40°C to +125°C	8 WLP	+AAH
MAX44285FAUA+	50	-40°C to +125°C	8 $\mu$ MAX	—
MAX44285HAWA+	100	-40°C to +125°C	8 WLP	+AAI
MAX44285HAUA+	100	-40°C to +125°C	8 $\mu$ MAX	—

+Denotes a lead(Pb)-free/RoHS-compliant package.

## Chip Information

PROCESS: BICMOS

## Package Information

For the latest package outline information and land patterns (footprints), go to [www.maximintegrated.com/packages](http://www.maximintegrated.com/packages). Note that a "+", "#", or "-" in the package code indicates RoHS status only. Package drawings may show a different suffix character, but the drawing pertains to the package regardless of RoHS status.

PACKAGE TYPE	PACKAGE CODE	OUTLINE NO.	LAND PATTERN NO.
8 WLP	W81A2+2	<a href="#">21-0210</a>	Refer to <a href="#">Application Note 1891</a>
8 $\mu$ MAX	U8+1	<a href="#">21-0036</a>	<a href="#">90-0092</a>

## Revision History

REVISION NUMBER	REVISION DATE	DESCRIPTION	PAGES CHANGED
0	1/14	Initial release	—
1	2/14	Revised <i>Pin Description</i> , <i>Functional Diagram</i> , <i>Detailed Description</i> and added Table 1	7, 8, 9
2	7/14	Revised data sheet to change common-mode range from 36V to 76V	1–6, 8–10
3	12/14	Released WLP packages and updated <i>Electrical Characteristics</i>	2, 11

For pricing, delivery, and ordering information, please contact Maxim Direct at 1-888-629-4642, or visit Maxim Integrated's website at [www.maximintegrated.com](http://www.maximintegrated.com).

Maxim Integrated cannot assume responsibility for use of any circuitry other than circuitry entirely embodied in a Maxim Integrated product. No circuit patent licenses are implied. Maxim Integrated reserves the right to change the circuitry and specifications without notice at any time. The parametric values (min and max limits) shown in the *Electrical Characteristics* table are guaranteed. Other parametric values quoted in this data sheet are provided for guidance.

Компания «Life Electronics» занимается поставками электронных компонентов импортного и отечественного производства от производителей и со складов крупных дистрибьюторов Европы, Америки и Азии.

С конца 2013 года компания активно расширяет линейку поставок компонентов по направлению коаксиальный кабель, кварцевые генераторы и конденсаторы (керамические, пленочные, электролитические), за счёт заключения дистрибьюторских договоров

Мы предлагаем:

- Конкуренспособные цены и скидки постоянным клиентам.
- Специальные условия для постоянных клиентов.
- Подбор аналогов.
- Поставку компонентов в любых объемах, удовлетворяющих вашим потребностям.
- Приемлемые сроки поставки, возможна ускоренная поставка.
- Доставку товара в любую точку России и стран СНГ.
- Комплексную поставку.
- Работу по проектам и поставку образцов.
- Формирование склада под заказчика.
- Сертификаты соответствия на поставляемую продукцию (по желанию клиента).
- Тестирование поставляемой продукции.
- Поставку компонентов, требующих военную и космическую приемку.
- Входной контроль качества.
- Наличие сертификата ISO.

В составе нашей компании организован Конструкторский отдел, призванный помогать разработчикам, и инженерам.

Конструкторский отдел помогает осуществить:

- Регистрацию проекта у производителя компонентов.
- Техническую поддержку проекта.
- Защиту от снятия компонента с производства.
- Оценку стоимости проекта по компонентам.
- Изготовление тестовой платы монтаж и пусконаладочные работы.



Тел: +7 (812) 336 43 04 (многоканальный)

Email: [org@lifeelectronics.ru](mailto:org@lifeelectronics.ru)