



Film Capacitors

EMI Suppression Capacitors (MKP)

Series/Type: B32921C/D ... B32928C/D

Date: September 2019

Typical applications

- X2 class for interference suppression
- "Across the line" applications

Climatic

- Max. operating temperature: 110 °C
- Climatic category (IEC 60068-1:2013):
40/105/56 (ENEC10)
40/110/56 (ENEC15)

Construction

- Dielectric: polypropylene (MKP)
- Plastic case (UL 94 V-0)
- Epoxy resin sealing (UL 94 V-0)

Features

- Very small dimensions
- Self-healing properties
- RoHS-compatible
- Halogen-free capacitors available on request

Terminals

- Parallel wire leads, lead-free tinned
- Special lead lengths available on request

Marking

Manufacturer's logo, lot number, date code, rated capacitance (coded), cap. tolerance (code letter), rated AC voltage, series number, sub-class (X2), dielectric code (MKP), climatic category, passive flammability category, approvals.

Delivery mode

Bulk (untaped)
Taped (Ammo pack or reel)
For taping details, refer to chapter "Taping and packing"

Dimensional drawings

Drawing 1

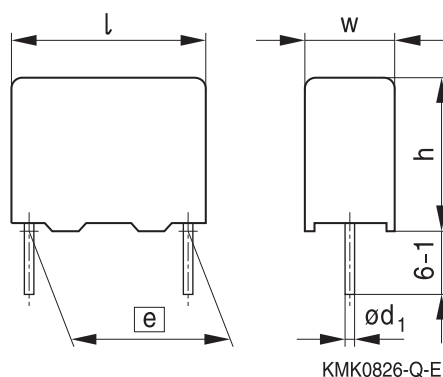

Drawing 2

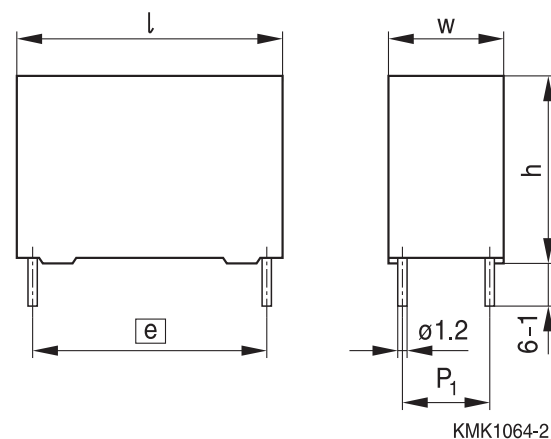

Dimensions in mm

$P_1 = 20.3 \text{ mm}$

Lead spacing $e \pm 0.4$	Lead diameter $d_1 \pm 0.05$	Type	Drawing
10	0.6	B32921	1
15	0.8	B32922	1
22.5	0.8	B32923	1
27.5	0.8	B32924	1
37.5	1.0	B32926	1 / 2 ¹⁾
52.5	1.2	B32928	2

1) A few individual types only

B32921C/D ... B32928C/D

X2 / 305 V AC

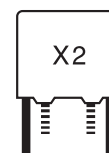

Marking Examples

C ≤ 10 μF



KMK1541-3

C > 10 μF



KMK1542-2

Approvals

Approval marks	Standards	Certificate
	EN 60384-14:2014 IEC 60384-14:2013	40010694 (approved by VDE) (C ≤ 10 μF)
	EN 60384-14:2014 IEC 60384-14:2013	E97863 (approved by UL)
	UL 1414:2000 UL 1283:2005	E97863 / E157153
	CSA C22.2 No.1:2004 CSA C22.2 No.8:2013	E97863 / E157153 (approved by UL)
	CQC (GB/T 14472-1998):1998	CQC06001015331 / CQC06001016454 (C ≤ 10 μF)
	UL 60384-14:2014 CSA E60384-14:2013	E97863 (approved by UL)

Notes:

Effective January 2014, only for EMI suppression capacitors:

- UL 60384-14:2014 certification replaces both UL 1414:2000 and UL 1283:2005 standards.
- CSA C22.2 No.1.2004 and CSA C22.2 No.8:2013 are replaced by CSA E60384-14:2013.
- References like 1414, 1283 are removed from the capacitor marking.

Capacitors under UL 1414:2000, UL 1283:2005 produced during or before 2013, are accepted under UL scope.

Capacitors under CSA C22.2 No.1:2004 / CSA C22.2 No.8:2013 produced during or before 2013, are accepted under cUL scope.

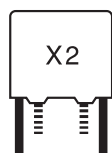

B32921C/D ... B32928C/D

X2 / 305 V AC

Overview of available types

Lead spacing	10 mm	15 mm	22.5 mm	27.5 mm	37.5 mm	52.5 mm
Type	B32921C/D	B32922C/D	B32923C/D	B32924C/D	B32926C/D	B32928C/D
C_R (μ F)						
0.010						
0.022						
0.033						
0.047						
0.068						
0.10						
0.15						
0.22						
0.33						
0.47						
0.68						
1.0						
1.5						
2.2						
3.3						
3.9						
4.7						
5.6						
6.8						
8.2						
10						
15						
20						
25						
30						

B32921C/D

X2 / 305 V AC

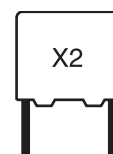

Ordering codes and packing units (lead spacing 10.0 mm)

C _R μF	Max. dimensions w × h × l mm	Ordering code (composition see below)	Ammo pack pcs./MOQ	Reel pcs./MOQ	Untaped pcs./MOQ	Pins
0.010	4.0 × 9.0 × 13.0	B32921C3103+*** ◆	4000	6800	4000	2
0.022	4.0 × 9.0 × 13.0	B32921C3223+*** ◆	4000	6800	4000	2
0.033	4.0 × 9.0 × 13.0	B32921C3333+*** ◆	4000	6800	4000	2
0.047	5.0 × 11.0 × 13.0	B32921C3473+*** ◆	3320	5200	4000	2
0.068	6.0 × 12.0 × 13.0	B32921C3683+***	2720	4400	4000	2
0.10	6.0 × 12.0 × 13.0	B32921C3104M***	2720	4400	4000	2

◆ Preferred type

MOQ = Minimum Order Quantity, consisting of 4 packing units.

Further intermediate capacitance values on request.

Composition of ordering code

+ = Capacitance tolerance code:

M = ±20%

K = ±10%

*** = Packaging code:

289 = Straight terminals, Ammo pack

189 = Straight terminals, Reel

003 = Straight terminals, untaped
(lead length 3.2 ±0.3 mm)

000 = Straight terminals, untaped
(lead length 6 – 1 mm)

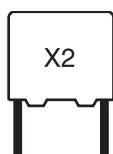

B32922C/D

X2 / 305 V AC

Ordering codes and packing units (lead spacing 15.0 mm)

C _R μF	Max. dimensions w × h × l mm	Ordering code (composition see below)	Ammo pack pcs./MOQ	Reel pcs./MOQ	Untaped pcs./MOQ	Pins
0.033	5.0 × 10.5 × 18.0	B32922C3333K***	4680	5200	4000	2
0.047	5.0 × 10.5 × 18.0	B32922C3473K***	4680	5200	4000	2
0.068	5.0 × 10.5 × 18.0	B32922C3683K*** ◆	4680	5200	4000	2
0.10	5.0 × 10.5 × 18.0	B32922C3104+*** ◆	4680	5200	4000	2
0.15	6.0 × 12.0 × 18.0	B32922C3154+*** ◆	3840	4400	4000	2
0.22	7.0 × 12.5 × 18.0	B32922C3224+*** ◆	3320	3600	4000	2
0.33	8.0 × 14.0 × 18.0	B32922C3334M*** ◆	2920	3000	2000	2
0.33	8.5 × 14.5 × 18.0	B32922D3334K***	2720	2800	2000	2
0.47	9.0 × 17.5 × 18.0	B32922C3474+*** ◆	2560	2800	2000	2
0.68	11.0 × 18.5 × 18.0	B32922C3684+*** ◆	—	2200	1200	2

◆ Preferred type

MOQ = Minimum Order Quantity, consisting of 4 packing units.

Further intermediate capacitance values on request.

Composition of ordering code

+ = Capacitance tolerance code:

M = ±20%

K = ±10%

*** = Packaging code:

289 = Straight terminals, Ammo pack

189 = Straight terminals, Reel

003 = Straight terminals, untaped
(lead length 3.2 ±0.3 mm)

000 = Straight terminals, untaped
(lead length 6 – 1 mm)

B32923C/D

X2 / 305 V AC

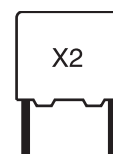

Ordering codes and packing units (lead spacing 22.5 mm)

C_R	Max. dimensions $w \times h \times l$ mm	Ordering code (composition see below)	Ammo pack pcs./MOQ	Reel pcs./MOQ	Untaped pcs./MOQ	Pins
0.22	6.0 × 15.0 × 26.5	B32923C3224+***	2720	2800	2880	2
0.33	6.0 × 15.0 × 26.5	B32923C3334M***	2720	2800	2880	2
0.33	7.0 × 16.0 × 26.5	B32923D3334K***	2320	2400	2520	2
0.47	8.5 × 16.5 × 26.5	B32923C3474+***	1920	2000	2040	2
0.68	10.5 × 16.5 × 26.5	B32923C3684+***	1560	1600	2160	2
1.0	11.0 × 20.5 × 26.5	B32923C3105+*** ◆	1480	1400	2040	2
1.5	12.0 × 22.0 × 26.5	B32923C3155M***	—	—	1800	2
2.2	14.5 × 29.5 × 26.5	B32923C3225+***	—	—	1040	2

◆ Preferred type

MOQ = Minimum Order Quantity, consisting of 4 packing units.

Further intermediate capacitance values on request.

Composition of ordering code

+ = Capacitance tolerance code:

M = ±20%

K = ±10%

*** = Packaging code:

289 = Straight terminals, Ammo pack

189 = Straight terminals, Reel

003 = Straight terminals, untaped
(lead length 3.2 ±0.3 mm)

000 = Straight terminals, untaped
(lead length 6 – 1 mm)

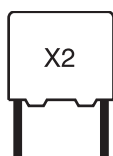

B32924C/D

X2 / 305 V AC

Ordering codes and packing units (lead spacing 27.5 mm)

C _R μF	Max. dimensions w × h × l mm	Ordering code (composition see below)	Ammo pack pcs./MOQ	Reel pcs./MOQ	Untaped pcs./MOQ	Pins
0.68	11.0 × 19.0 × 31.5	B32924C3684+***	—	1400	1280	2
1.0	11.0 × 19.0 × 31.5	B32924C3105+***	—	1400	1280	2
1.5	12.5 × 21.5 × 31.5	B32924C3155+*** ◆	—	1200	1120	2
2.2	14.0 × 24.5 × 31.5	B32924C3225+***	—	—	1040	2
3.3	16.0 × 32.0 × 31.5	B32924D3335K***	—	—	880	2
3.3	18.0 × 27.5 × 31.5	B32924C3335M***	—	—	800	2
4.7	18.0 × 33.0 × 31.5	B32924C3475M***	—	—	800	2
4.7	21.0 × 31.0 × 31.5	B32924D3475K***	—	—	720	2
5.6	22.0 × 36.5 × 31.5	B32924C3565+***	—	—	784	2

◆ Preferred type

MOQ = Minimum Order Quantity, consisting of 4 packing units.

Further intermediate capacitance values on request.

Composition of ordering code

+ = Capacitance tolerance code:

M = ±20%

K = ±10%

*** = Packaging code:

289 = Straight terminals, Ammo pack

189 = Straight terminals, Reel

003 = Straight terminals, untaped
(lead length 3.2 ±0.3 mm)

000 = Straight terminals, untaped
(lead length 6 – 1 mm)

B32926C/D

X2 / 305 V AC

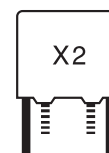

Ordering codes and packing units (lead spacing 37.5 mm)

C_R	Max. dimensions $w \times h \times l$ mm	Ordering code (composition see below)	Ammo pack pcs./MOQ	Reel pcs./MOQ	Untaped pcs./MOQ	Pins
2.2	14.0 × 25.0 × 41.5	B32926C3225+***	—	—	1380	2
3.3	16.0 × 28.5 × 41.5	B32926C3335+***	—	—	800	2
3.9	16.0 × 28.5 × 41.5	B32926C3395+***	—	—	800	2
4.7	18.0 × 32.5 × 41.5	B32926C3475+***	—	—	720	2
5.6	18.0 × 32.5 × 41.5	B32926C3565+***	—	—	720	2
6.8	20.0 × 39.5 × 42.0	B32926C3685+***	—	—	640	2
8.2	20.0 × 39.5 × 42.0	B32926C3825+***	—	—	640	2
10	28.0 × 42.5 × 42.0	B32926C3106+***	—	—	440	2
15	30.0 × 45.0 × 42.0	B32926C3156M***	—	—	400	2
15	33.0 × 48.0 × 42.0	B32926D3156+***	—	—	180	4

MOQ = Minimum Order Quantity, consisting of 4 packing units.

Further intermediate capacitance values on request.

Composition of ordering code

+ = Capacitance tolerance code:

M = ±20%

K = ±10%

*** = Packaging code:

289 = Straight terminals, Ammo pack

189 = Straight terminals, Reel

003 = Straight terminals, untaped
(lead length 3.2 ±0.3 mm)

000 = Straight terminals, untaped
(lead length 6 – 1 mm)

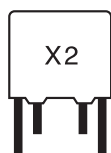

B32928C/D

X2 / 305 V AC

Ordering codes and packing units (lead spacing 52.5 mm)

C_R	Max. dimensions $w \times h \times l$ mm	Ordering code (composition see below)	Ammo pack pcs./MOQ	Reel pcs./MOQ	Untaped pcs./MOQ	Pins
20	30.0 × 45.0 × 57.5	B32928C3206+***	—	—	280	4
25	35.0 × 50.0 × 57.5	B32928C3256+***	—	—	108	4
30	35.0 × 50.0 × 57.5	B32928C3306M***	—	—	108	4

MOQ = Minimum Order Quantity, consisting of 4 packing units.

Further intermediate capacitance values on request.

Composition of ordering code

+ = Capacitance tolerance code:

M = ±20%

K = ±10%

*** = Packaging code:

289 = Straight terminals, Ammo pack

189 = Straight terminals, Reel

003 = Straight terminals, untaped
(lead length 3.2 ±0.3 mm)

000 = Straight terminals, untaped
(lead length 6 – 1 mm)

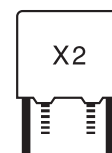

Technical data

Reference standard: IEC 60384-14:2013. All data given at $T = 20\text{ °C}$, unless otherwise specified.

Max. operating temperature $T_{op,max}$	+110 °C			
Dissipation factor $\tan \delta$ (in 10^{-3}) at 20 °C (upper limit values)	at	$C_R \leq 0.1\ \mu\text{F}$	$0.1\ \mu\text{F} < C_R \leq 2.2\ \mu\text{F}$	$C_R > 2.2\ \mu\text{F}$
	1 kHz	1.0	1.0	2.0
	100 kHz	5.0	—	—
Insulation resistance R_{ins} or time constant $\tau = C_R \cdot R_{ins}$ at 20 °C, rel. humidity $\leq 65\%$ (minimum as-delivered values)	$C_R \leq 0.33\ \mu\text{F}$	$C_R > 0.33\ \mu\text{F}$		
	100 000 M Ω	30 000 s		
DC test voltage	2121 V, 2 s ($C \leq 10\ \mu\text{F}$) / 1312 V, 2 s ($C > 10\ \mu\text{F}$)			
<i>The repetition of this DC voltage test may damage the capacitor. Special care must be taken in case of use several capacitors in a parallel configuration.</i>				
Passive flammability category	B			
Maximum continuous DC voltage V_{DC}	630 V			
Maximum continuous AC voltage V_{AC}	310 V (50/60 Hz)			
Rated AC voltage (IEC 60384-14)	305 V (50/60 Hz)			
Operating AC voltage V_{op} at high temperature	$T_{op} \leq 110\text{ °C}$	$V_{op} = V_{AC}$ (continuously)		
	$T_{op} \leq 110\text{ °C}$	$V_{op} = 1.25 \cdot V_{AC}$ (1000 h)		
Damp heat test	56 days / 40 °C / 93% relative humidity			
Limit values after damp heat test	Capacitance change $ \Delta C/C $	$\leq 5\%$		
	Dissipation factor change $\Delta \tan \delta$	$\leq 5 \cdot 10^{-3}$ (at 1 kHz)		
		$\leq 1.0 \cdot 10^{-3}$ (at 10 kHz)		
	Insulation resistance R_{ins} or time constant $\tau = C_R \cdot R_{ins}$	$\geq 50\%$ of minimum as-delivered values		

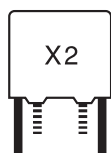

B32921C/D ... B32928C/D

X2 / 305 V AC

Pulse handling capability

"dV/dt" represents the maximum permissible voltage change per unit of time for non-sinusoidal voltages, expressed in V/μs.

"k₀" represents the maximum permissible pulse characteristic of the waveform applied to the capacitor, expressed in V²/μs.

Note:

The values of dV/dt and k₀ provided below must not be exceeded in order to avoid damaging the capacitor.

dV/dt and k₀ values

Lead spacing	10 mm	15 mm	22.5 mm	27.5 mm	37.5 mm	52.5 mm
dV/dt in V/μs	475	340	170	120	80	50
k ₀ in V ² /μs	408500	292400	146200	103200	68800	43200

Impedance Z versus frequency f

(typical values)

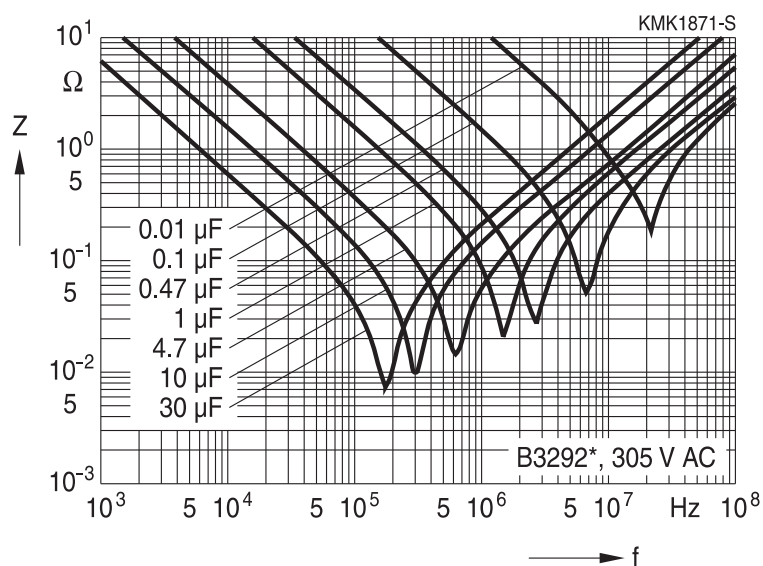

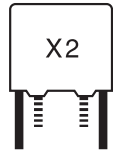

Permissible AC current I_{RMS} versus frequency f (for sinusoidal waveforms $T_A \leq 90^\circ\text{C}$ and $\Delta ESR < 100\%$ from receipt condition)

Lead spacing 10 mm

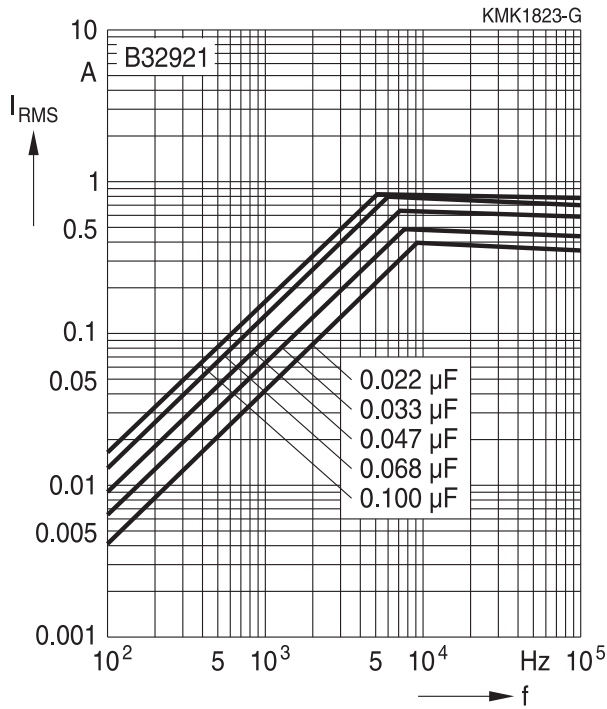

Lead spacing 15 mm

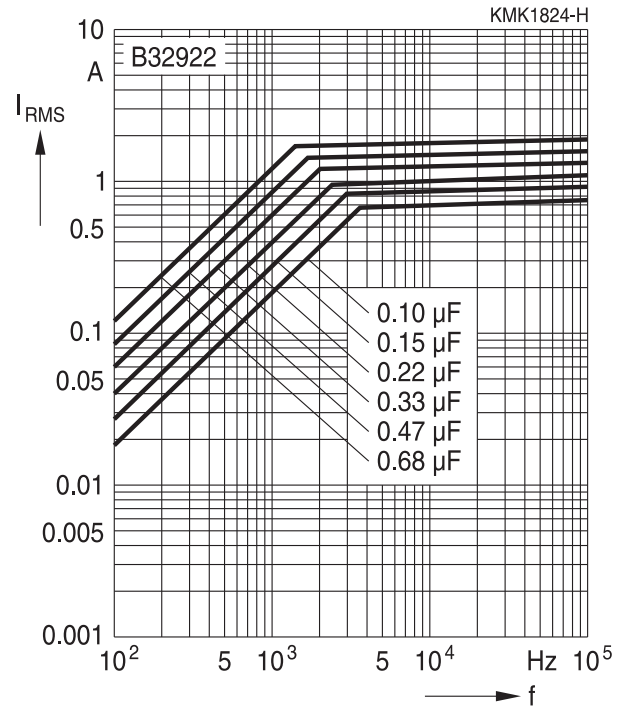

Lead spacing 22.5 mm

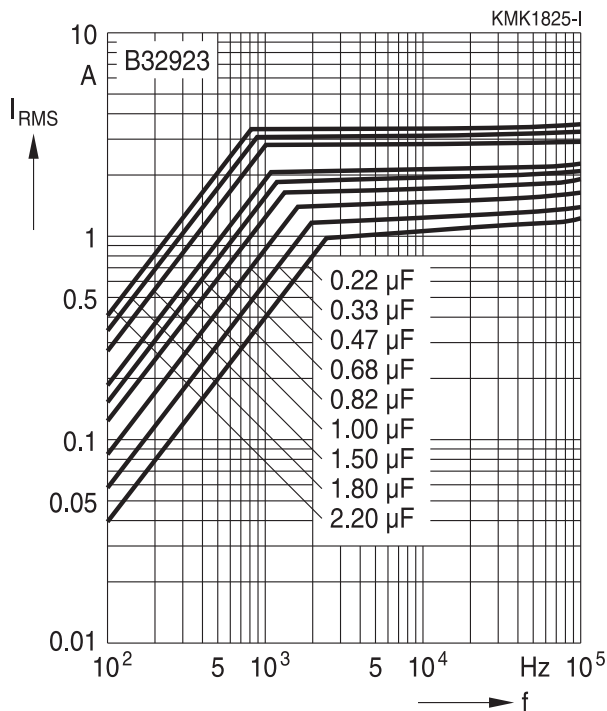

Lead spacing 27.5 mm

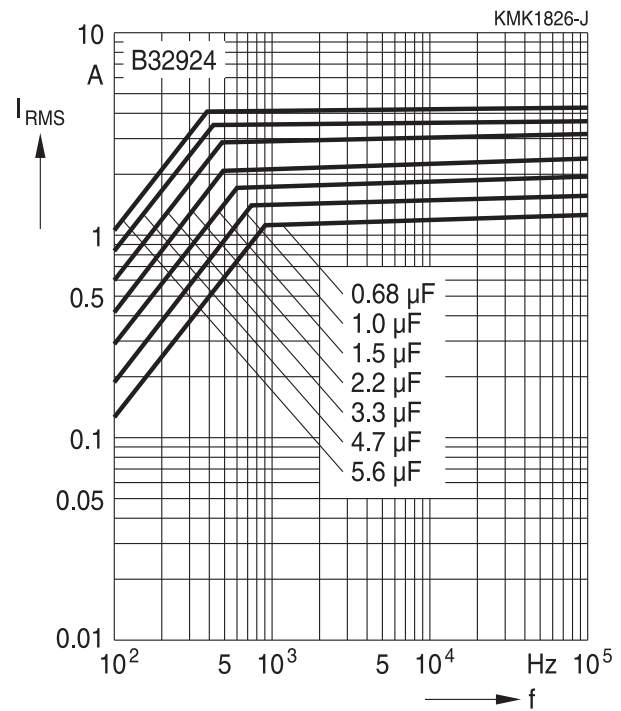

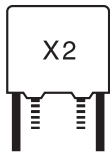

B32921C/D ... B32928C/D

X2 / 305 V AC

Permissible AC current I_{RMS} versus frequency f (for sinusoidal waveforms $T_A \leq 90^\circ\text{C}$ and $\Delta ESR < 100\%$ from receipt condition)

Lead spacing 37.5 mm

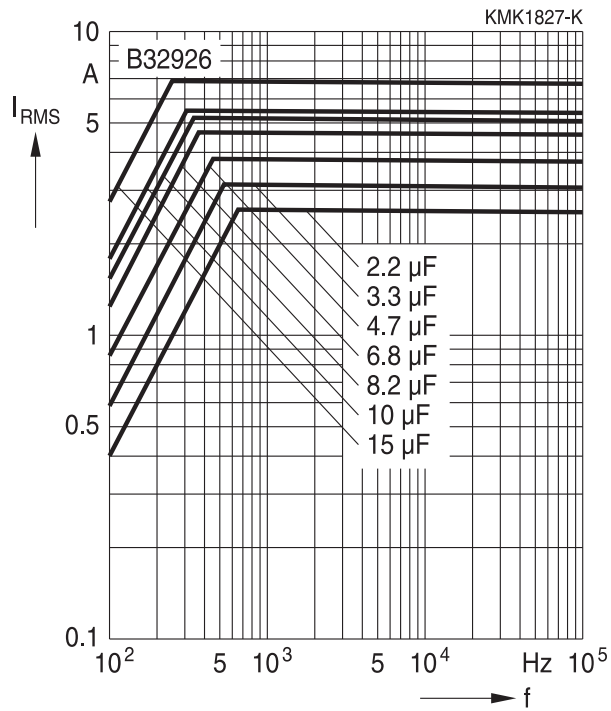

Lead spacing 52.5 mm

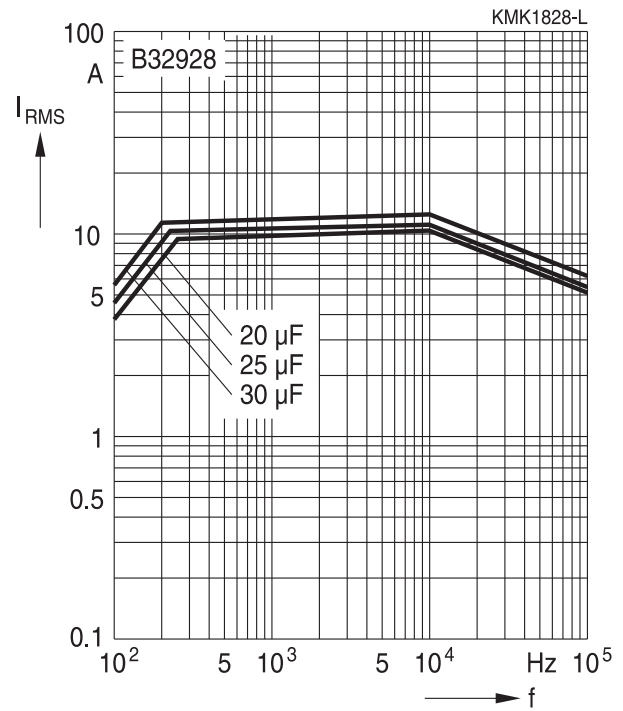

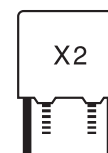

Testing and Standards

Test	Reference	Conditions of test	Performance requirements
Electrical parameters	IEC 60384-14:2013	Voltage Proof: Between terminals: $4.3 \times V_R$ (DC), 1 min Terminals and enclosure: $2 V_R + 1500$ V AC Insulation resistance, R_{ins} Capacitance, C Dissipation factor, $\tan \delta$	Within specified limits
Robustness of terminations	IEC 60068-2-21:2006	Tensile strength (test Ua1)	Capacitance and $\tan \delta$ within specified limits
		Wire diameter	
		$0.5 < d_1 \leq 0.8$ mm	10 N
		$0.8 < d_1 \leq 1.25$ mm	20 N
Resistance to soldering heat	IEC 60068-2-20:2008, test Tb, method 1A	Solder bath temperature at 260 ± 5 °C, immersion for 10 seconds	$\Delta C/C_0 \leq 5\%$ $\tan \delta$ within specified limits
Rapid change of temperature	IEC 60384-14:2013	T_A = lower category temperature T_B = upper category temperature Five cycles, duration $t = 30$ min.	No visible damage $ \Delta C/C_0 \leq 5\%$ $\tan \delta$ within specified limits
Damp heat, steady state	IEC 60384-14:2013	Test Ca 40 °C / 93% RH / 56 days	No visible damage $ \Delta C/C_0 \leq 5\%$ $ \Delta \tan \delta \leq 0.008$ for $C \leq 1$ μ F $ \Delta \tan \delta \leq 0.005$ for $C > 1$ μ F Voltage proof $R_{ins} \geq 50\%$ of initial limit
Impulse test Endurance	IEC 60384-14:2013	3 impulses $T_B / 1.25 V_R / 1000$ hours, $1000 V_{RMS}$ for 0.1 s every hour	No visible damage $ \Delta C/C_0 \leq 10\%$ $ \Delta \tan \delta \leq 0.008$ for $C \leq 1$ μ F $ \Delta \tan \delta \leq 0.005$ for $C > 1$ μ F Voltage proof $R_{ins} \geq 50\%$ of initial limit
Passive flammability	IEC 60384-14:2013	Flame applied for a period of time depending on capacitor volume	B
Active flammability	IEC 60384-14:2013	20 discharges at 2.5 kV + V_R	The cheesecloth shall not burn with a flame

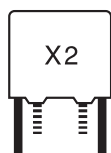

B32921C/D ... B32928C/D

X2 / 305 V AC

Mounting guidelines

1 Soldering

1.1 Solderability of leads

The solderability of terminal leads is tested to IEC 60068-2-20:2008, test Ta, method 1.

Before a solderability test is carried out, terminals are subjected to accelerated ageing (to IEC 60068-2-2:2007, test Ba: 4 h exposure to dry heat at 155 °C). Since the ageing temperature is far higher than the upper category temperature of the capacitors, the terminal wires should be cut off from the capacitor before the ageing procedure to prevent the solderability being impaired by the products of any capacitor decomposition that might occur.

Solder bath temperature	235 ±5 °C
Soldering time	2.0 ±0.5 s
Immersion depth	2.0 +0/−0.5 mm from capacitor body or seating plane
Evaluation criteria:	
Visual inspection	Wetting of wire surface by new solder ≥90%, free-flowing solder

1.2 Resistance to soldering heat

Resistance to soldering heat is tested to IEC 60068-2-20:2008, test Tb, method 1.

Conditions:

Series	Solder bath temperature	Soldering time
MKT boxed (except 2.5 × 6.5 × 7.2 mm) coated uncoated (lead spacing >10 mm)	260 ±5 °C	10 ±1 s
MFP MKP (lead spacing >7.5 mm)		
MKT boxed (case 2.5 × 6.5 × 7.2 mm)		5 ±1 s
MKP (lead spacing ≤7.5 mm)		<4 s
MKT uncoated (lead spacing ≤10 mm) insulated (B32559)		recommended soldering profile for MKT uncoated (lead spacing ≤ 10 mm) and insulated (B32559)

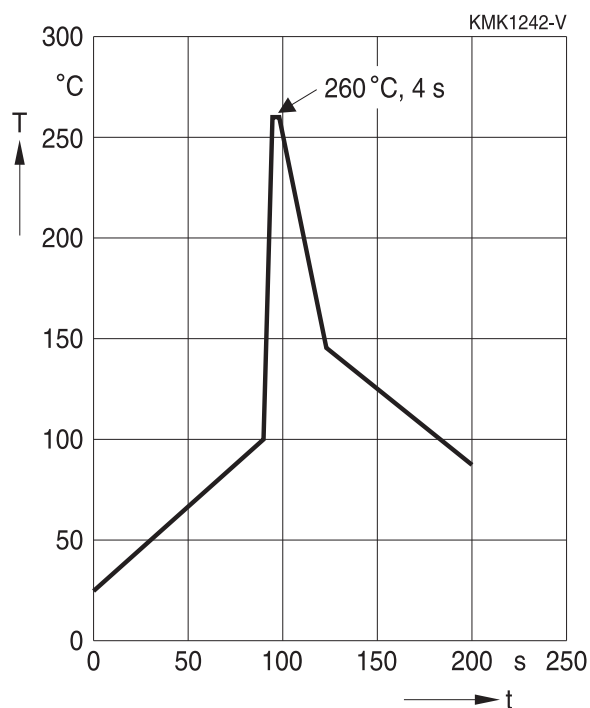
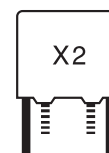

Immersion depth	2.0 +0/−0.5 mm from capacitor body or seating plane
Shield	Heat-absorbing board, (1.5 ±0.5) mm thick, between capacitor body and liquid solder
Evaluation criteria:	
Visual inspection	No visible damage
$\Delta C/C_0$	2% for MKT/MKP/MFP 5% for EMI suppression capacitors
$\tan \delta$	As specified in sectional specification

1.3 General notes on soldering

Permissible heat exposure loads on film capacitors are primarily characterized by the upper category temperature T_{max} . Long exposure to temperatures above this type-related temperature limit can lead to changes in the plastic dielectric and thus change irreversibly a capacitor's electrical characteristics. For short exposures (as in practical soldering processes) the heat load (and thus the possible effects on a capacitor) will also depend on other factors like:

- Pre-heating temperature and time
- Forced cooling immediately after soldering
- Terminal characteristics:
diameter, length, thermal resistance, special configurations (e.g. crimping)
- Height of capacitor above solder bath
- Shadowing by neighboring components
- Additional heating due to heat dissipation by neighboring components
- Use of solder-resist coatings

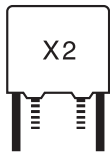

B32921C/D ... B32928C/D

X2 / 305 V AC

The overheating associated with some of these factors can usually be reduced by suitable countermeasures. For example, if a pre-heating step cannot be avoided, an additional or reinforced cooling process may possibly have to be included.

Recommendations

As a reference, the recommended wave soldering profile for our film capacitors is as follows:

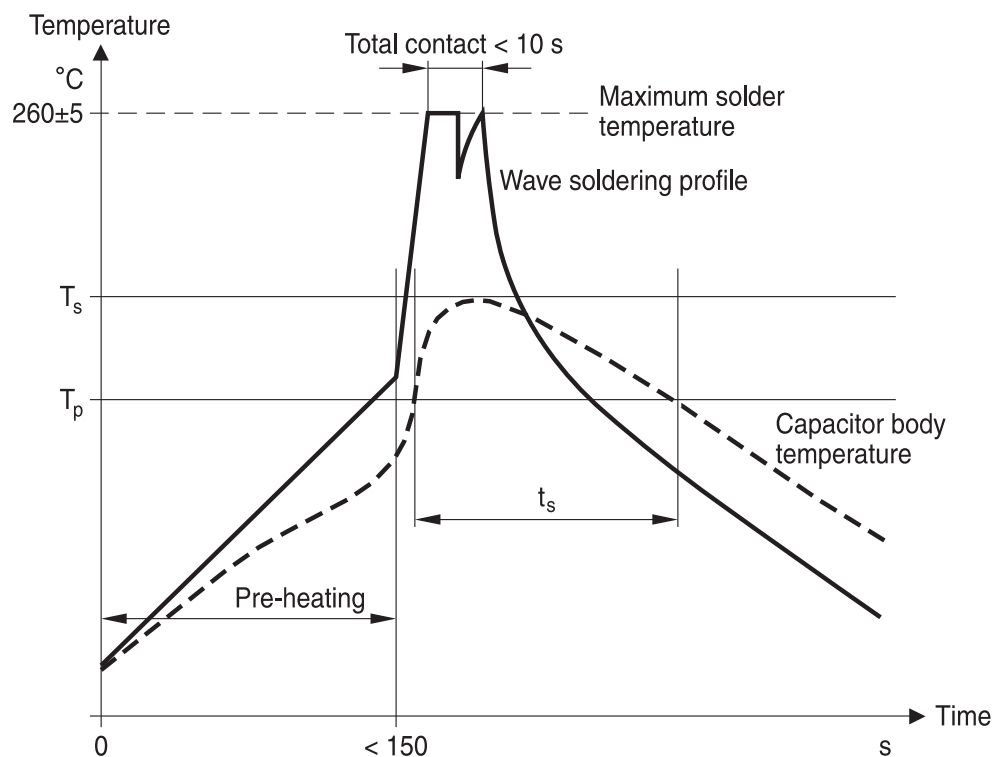

T_s : Capacitor body maximum temperature at wave soldering

T_p : Capacitor body maximum temperature at pre-heating

KMK1745-A-E

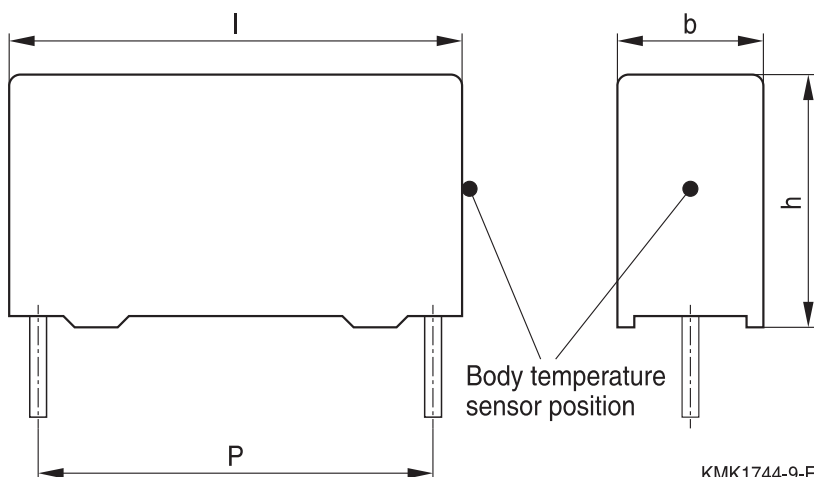

KMK1744-9-E

B32921C/D ... B32928C/D

X2 / 305 V AC

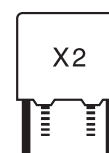

Body temperature should follow the description below:

- MKP capacitor
 - During pre-heating: $T_p \leq 110 \text{ }^\circ\text{C}$
 - During soldering: $T_s \leq 120 \text{ }^\circ\text{C}$, $t_s \leq 45 \text{ s}$
- MKT capacitor
 - During pre-heating: $T_p \leq 125 \text{ }^\circ\text{C}$
 - During soldering: $T_s \leq 160 \text{ }^\circ\text{C}$, $t_s \leq 45 \text{ s}$

When SMD components are used together with leaded ones, the film capacitors should not pass into the SMD adhesive curing oven. The leaded components should be assembled after the SMD curing step.

Leaded film capacitors are not suitable for reflow soldering.

In order to ensure proper conditions for manual or selective soldering, the body temperature of the capacitor (T_s) must be $\leq 120 \text{ }^\circ\text{C}$.

One recommended condition for manual soldering is that the tip of the soldering iron should be $< 360 \text{ }^\circ\text{C}$ and the soldering contact time should be no longer than 3 seconds.

For uncoated MKT capacitors with lead spacings $\leq 10 \text{ mm}$ (B32560/B32561) the following measures are recommended:

- pre-heating to not more than $110 \text{ }^\circ\text{C}$ in the preheater phase
- rapid cooling after soldering

Please refer to our Film Capacitors Data Book in case more details are needed.

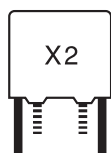

B32921C/D ... B32928C/D

X2 / 305 V AC

Application note for the different possible X1 / X2 positions

In series with the powerline (i.e. capacitive power supply)

Typical Applications:

- Power meters
- ECUs for white goods and household appliances
- Different sensor applications
- Severe ambient conditions

Basic circuit

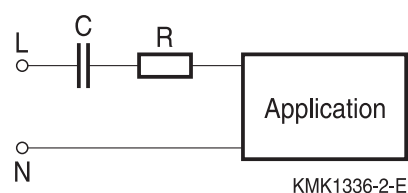

Required features

- High capacitance stability over the lifetime
- Narrow tolerances for a controlled current supply

Recommended product series

- B3293* (305 V AC) heavy duty with EN approval for X2 (UL Q1/2010)
- B3265* MKP series
standard MKP capacitor without safety approvals
- B3267*L MKP series
standard MKP capacitor without safety approvals
- B3292*H/J (305 V AC), severe ambient condition, approved as X2

In parallel with the powerline

Typical Applications:

Standard X2 are used parallel over the mains for reducing electromagnetic interferences coming from the grid. For such purposes they must meet the applicable EMC directives and standards.

Basic circuit

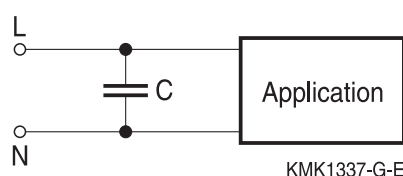

Required features

- Standard safety approvals (ENEC, UL, CSA, CQC)
- High pulse load capability
- Withstand surge voltages

Recommended product series

- B3292*C/D (305 V AC)
standard series, approved as X2
- B3291* (330 V AC), approved as X1
- B3291* (530 V AC), approved as X1
- B3291* (550 V AC), approved as X1
- B3292*H/J (305 V AC), severe ambient condition, approved as X2

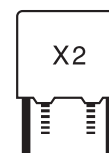

Cautions and warnings

- Do not exceed the upper category temperature (UCT).
- Do not apply any mechanical stress to the capacitor terminals.
- Avoid any compressive, tensile or flexural stress.
- Do not move the capacitor after it has been soldered to the PC board.
- Do not pick up the PC board by the soldered capacitor.
- Do not place the capacitor on a PC board whose PTH hole spacing differs from the specified lead spacing.
- Do not exceed the specified time or temperature limits during soldering.
- Avoid external energy inputs, such as fire or electricity.
- Avoid overload of the capacitors.
- Consult us if application is with severe temperature and humidity condition.
- There are no serviceable or repairable parts inside the capacitor. Opening the capacitor or any attempts to open or repair the capacitor will void the warranty and liability of TDK Electronics.
- Please note that the standards referred to in this publication may have been revised in the meantime.

The table below summarizes the safety instructions that must always be observed. A detailed description can be found in the relevant sections of the chapters "General technical information" and "Mounting guidelines".

Topic	Safety information	Reference chapter "General technical information"
Storage conditions	Make sure that capacitors are stored within the specified range of time, temperature and humidity conditions.	4.5 "Storage conditions"
Flammability	Avoid external energy, such as fire or electricity (passive flammability), avoid overload of the capacitors (active flammability) and consider the flammability of materials.	5.3 "Flammability"
Resistance to vibration	Do not exceed the tested ability to withstand vibration. The capacitors are tested to IEC 60068-2-6:2007. TDK Electronics offers film capacitors specially designed for operation under more severe vibration regimes such as those found in automotive applications. Consult our catalog "Film Capacitors for Automotive Electronics".	5.2 "Resistance to vibration"

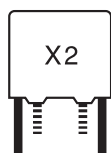

B32921C/D ... B32928C/D

X2 / 305 V AC

Topic	Safety information	Reference chapter "Mounting guidelines"
Soldering	Do not exceed the specified time or temperature limits during soldering.	1 "Soldering"
Cleaning	Use only suitable solvents for cleaning capacitors.	2 "Cleaning"
Embedding of capacitors in finished assemblies	When embedding finished circuit assemblies in plastic resins, chemical and thermal influences must be taken into account. Caution: Consult us first, if you also wish to embed other uncoated component types!	3 "Embedding of capacitors in finished assemblies"

Design of our capacitors

Our EMI capacitors use polypropylene (PP) film metalized with a thin layer of Zinc (Zn). The following key points have made this design suitable to IEC/UL testing, holding a minimum size.

- Overvoltage AC capability with very high temperature Endurance test of IEC 60384-14:2013 (4th edition) / UL 60384-14:2014 (2nd edition) must be performed at $1.25 \times V_R$ at maximum temperature, during 1000 hours, with a capacitance drift less than 10%.
- Higher breakdown voltage withstanding if compared to other film metallizations, like Aluminum. IEC 60384-14:2013 (4th edition) / UL 60384-14:2014 (2nd edition) establishes high voltage tests performed at $4.3 \times V_R$ – 1 minute, impulse testing at 2500 V for C = 1 μ F and active flammability tests.
- Damp heat steady state: 40 °C/ 93% RH / 56 days. (without voltage or current load)

Effect of humidity on capacitance stability

Long contact of a film capacitor with humidity can produce irreversible effects. Direct contact with liquid water or excess exposure to high ambient humidity or dew will eventually remove the film metallization and thus destroy the capacitor. Plastic boxed capacitors must be properly tested in the final application at the worst expected conditions of temperature and humidity in order to check if any parameter drift may provoke a circuit malfunction.

In case of penetration of humidity through the film, the layer of Zinc can be degraded, specially under AC operation (change of polarity), accelerated by the temperature, provoking an increment of the serial resistance of the electrode and eventually a reduction of the capacitance value. For DC operation, the parameter drift is much less.

Plastic boxes and resins can not protect 100% against humidity. Metal enclosures, resin potting or coatings or similar measures by customers in their applications will offer additional protection against humidity penetration.

Display of ordering codes for TDK Electronics products

The ordering code for one and the same product can be represented differently in data sheets, data books, other publications, on the company website, or in order-related documents such as shipping notes, order confirmations and product labels. The varying representations of the order-

B32921C/D ... B32928C/D

X2 / 305 V AC

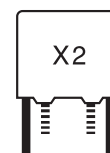

ing codes are due to different processes employed and do not affect the specifications of the respective products.

Detailed information can be found on the Internet under www.tdk-electronics.tdk.com/orderingcodes.

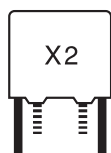

B32921C/D ... B32928C/D

X2 / 305 V AC

Symbols and terms

Symbol	English	German
α	Heat transfer coefficient	Wärmeübergangszahl
α_C	Temperature coefficient of capacitance	Temperaturkoeffizient der Kapazität
A	Capacitor surface area	Kondensatoroberfläche
β_C	Humidity coefficient of capacitance	Feuchtekoeffizient der Kapazität
C	Capacitance	Kapazität
C_R	Rated capacitance	Nennkapazität
ΔC	Absolute capacitance change	Absolute Kapazitätsänderung
$\Delta C/C$	Relative capacitance change (relative deviation of actual value)	Relative Kapazitätsänderung (relative Abweichung vom Ist-Wert)
$\Delta C/C_R$	Capacitance tolerance (relative deviation from rated capacitance)	Kapazitätstoleranz (relative Abweichung vom Nennwert)
dt	Time differential	Differentielle Zeit
Δt	Time interval	Zeitintervall
ΔT	Absolute temperature change (self-heating)	Absolute Temperaturänderung (Selbsterwärmung)
$\Delta \tan \delta$	Absolute change of dissipation factor	Absolute Änderung des Verlustfaktors
ΔV	Absolute voltage change	Absolute Spannungsänderung
dV/dt	Time differential of voltage function (rate of voltage rise)	Differentielle Spannungsänderung (Spannungsflankensteilheit)
$\Delta V/\Delta t$	Voltage change per time interval	Spannungsänderung pro Zeitintervall
E	Activation energy for diffusion	Aktivierungsenergie zur Diffusion
ESL	Self-inductance	Eigeninduktivität
ESR	Equivalent series resistance	Ersatz-Serienwiderstand
f	Frequency	Frequenz
f_1	Frequency limit for reducing permissible AC voltage due to thermal limits	Grenzfrequenz für thermisch bedingte Reduzierung der zulässigen Wechselspannung
f_2	Frequency limit for reducing permissible AC voltage due to current limit	Grenzfrequenz für strombedingte Reduzierung der zulässigen Wechselspannung
f_r	Resonant frequency	Resonanzfrequenz
F_D	Thermal acceleration factor for diffusion	Therm. Beschleunigungsfaktor zur Diffusion
F_T	Derating factor	Deratingfaktor
i	Current (peak)	Stromspitze
I_C	Category current (max. continuous current)	Kategoriestrom (max. Dauerstrom)

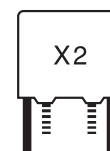

Symbol	English	German
I_{RMS}	(Sinusoidal) alternating current, root-mean-square value	(Sinusförmiger) Wechselstrom
i_z	Capacitance drift	Inkonstanz der Kapazität
k_0	Pulse characteristic	Impuls Kennwert
L_S	Series inductance	Serieninduktivität
λ	Failure rate	Ausfallrate
λ_0	Constant failure rate during useful service life	Konstante Ausfallrate in der Nutzungsphase
λ_{test}	Failure rate, determined by tests	Experimentell ermittelte Ausfallrate
P_{diss}	Dissipated power	Abgegebene Verlustleistung
P_{gen}	Generated power	Erzeugte Verlustleistung
Q	Heat energy	Wärmeenergie
ρ	Density of water vapor in air	Dichte von Wasserdampf in Luft
R	Universal molar constant for gases	Allg. Molarkonstante für Gas
R	Ohmic resistance of discharge circuit	Ohmscher Widerstand des Entladekreises
R_i	Internal resistance	Innenwiderstand
R_{ins}	Insulation resistance	Isolationswiderstand
R_P	Parallel resistance	Parallelwiderstand
R_S	Series resistance	Serienwiderstand
S	severity (humidity test)	Schärfegrad (Feuchtetest)
t	Time	Zeit
T	Temperature	Temperatur
τ	Time constant	Zeitkonstante
$\tan \delta$	Dissipation factor	Verlustfaktor
$\tan \delta_D$	Dielectric component of dissipation factor	Dielektrischer Anteil des Verlustfaktors
$\tan \delta_P$	Parallel component of dissipation factor	Parallelanteil des Verlustfaktors
$\tan \delta_S$	Series component of dissipation factor	Serienanteil des Verlustfaktors
T_A	Temperature of the air surrounding the component	Temperatur der Luft, die das Bauteil umgibt
T_{max}	Upper category temperature	Obere Kategorietemperatur
T_{min}	Lower category temperature	Untere Kategorietemperatur
t_{OL}	Operating life at operating temperature and voltage	Betriebszeit bei Betriebstemperatur und -spannung
T_{op}	Operating temperature, $T_A + \Delta T$	Betriebstemperatur, $T_A + \Delta T$
T_R	Rated temperature	Nenntemperatur
T_{ref}	Reference temperature	Referenztemperatur
t_{SL}	Reference service life	Referenz-Lebensdauer

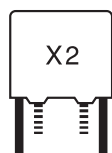

B32921C/D ... B32928C/D

X2 / 305 V AC

Symbol	English	German
V_{AC}	AC voltage	Wechselspannung
V_C	Category voltage	Kategorie spannung
$V_{C,RMS}$	Category AC voltage	(Sinusförmige) Kategorie-Wechselspannung
V_{CD}	Corona-discharge onset voltage	Teilentlade-Einsatzspannung
V_{ch}	Charging voltage	Ladespannung
V_{DC}	DC voltage	Gleichspannung
V_{FB}	Fly-back capacitor voltage	Spannung (Flyback)
V_i	Input voltage	Eingangsspannung
V_o	Output voltage	Ausgangsspannung
V_{op}	Operating voltage	Betriebsspannung
V_p	Peak pulse voltage	Impuls-Spitzen spannung
V_{pp}	Peak-to-peak voltage Impedance	Spannungshub
V_R	Rated voltage	Nennspannung
\hat{V}_R	Amplitude of rated AC voltage	Amplitude der Nenn-Wechselspannung
V_{RMS}	(Sinusoidal) alternating voltage, root-mean-square value	(Sinusförmige) Wechselspannung
V_{SC}	S-correction voltage	Spannung bei Anwendung "S-correction"
V_{sn}	Snubber capacitor voltage	Spannung bei Anwendung "Beschaltung"
Z	Impedance	Scheinwiderstand
e	Lead spacing	Rastermaß

Important notes

The following applies to all products named in this publication:

1. Some parts of this publication contain **statements about the suitability of our products for certain areas of application**. These statements are based on our knowledge of typical requirements that are often placed on our products in the areas of application concerned. We nevertheless expressly point out **that such statements cannot be regarded as binding statements about the suitability of our products for a particular customer application**. As a rule, we are either unfamiliar with individual customer applications or less familiar with them than the customers themselves. For these reasons, it is always ultimately incumbent on the customer to check and decide whether a product with the properties described in the product specification is suitable for use in a particular customer application.
2. We also point out that **in individual cases, a malfunction of electronic components or failure before the end of their usual service life cannot be completely ruled out in the current state of the art, even if they are operated as specified**. In customer applications requiring a very high level of operational safety and especially in customer applications in which the malfunction or failure of an electronic component could endanger human life or health (e.g. in accident prevention or lifesaving systems), it must therefore be ensured by means of suitable design of the customer application or other action taken by the customer (e.g. installation of protective circuitry or redundancy) that no injury or damage is sustained by third parties in the event of malfunction or failure of an electronic component.
3. **The warnings, cautions and product-specific notes must be observed.**
4. In order to satisfy certain technical requirements, **some of the products described in this publication may contain substances subject to restrictions in certain jurisdictions (e.g. because they are classed as hazardous)**. Useful information on this will be found in our Material Data Sheets on the Internet (www.tdk-electronics.tdk.com/material). Should you have any more detailed questions, please contact our sales offices.
5. We constantly strive to improve our products. Consequently, **the products described in this publication may change from time to time**. The same is true of the corresponding product specifications. Please check therefore to what extent product descriptions and specifications contained in this publication are still applicable before or when you place an order. We also **reserve the right to discontinue production and delivery of products**. Consequently, we cannot guarantee that all products named in this publication will always be available. The aforementioned does not apply in the case of individual agreements deviating from the foregoing for customer-specific products.
6. Unless otherwise agreed in individual contracts, **all orders are subject to our General Terms and Conditions of Supply**.

Important notes

7. **Our manufacturing sites serving the automotive business apply the IATF 16949 standard.** The IATF certifications confirm our compliance with requirements regarding the quality management system in the automotive industry. Referring to customer requirements and customer specific requirements (“CSR”) TDK always has and will continue to have the policy of respecting individual agreements. Even if IATF 16949 may appear to support the acceptance of unilateral requirements, we hereby like to emphasize that **only requirements mutually agreed upon can and will be implemented in our Quality Management System.** For clarification purposes we like to point out that obligations from IATF 16949 shall only become legally binding if individually agreed upon.
8. The trade names EPCOS, CeraCharge, CeraDiode, CeraLink, CeraPad, CeraPlas, CSMP, CTVS, DeltaCap, DigiSiMic, ExoCore, FilterCap, FormFit, LeaXield, MiniBlue, MiniCell, MKD, MKK, MotorCap, PCC, PhaseCap, PhaseCube, PhaseMod, PhiCap, PowerHap, PQSine, PQvar, SIFERRIT, SIFI, SIKOREL, SilverCap, SIMDAD, SiMic, SIMID, SineFormer, SIOV, ThermoFuse, WindCap are **trademarks registered or pending** in Europe and in other countries. Further information will be found on the Internet at www.tdk-electronics.tdk.com/trademarks.

Release 2018-10

Mouser Electronics

Authorized Distributor

Click to View Pricing, Inventory, Delivery & Lifecycle Information:

EPCOS / TDK:

[B32922C3224M000](#) [B32923C3155M000](#) [B32924C3475M000](#) [B32923C3224K189](#) [B32923C3224M189](#)
[B32922C3154M000](#) [B32921C3103K289](#) [B32921C3223K289](#) [B32921C3333K289](#) [B32921C3473K289](#)
[B32921C3103M289](#) [B32921C3223M289](#) [B32921C3333M289](#) [B32921C3473M289](#) [B32921C3683K289](#)
[B32921C3683M289](#) [B32921C3104M289](#) [B32922C3333K289](#) [B32922C3473K289](#) [B32922C3683K289](#)
[B32922C3104K289](#) [B32922C3154K289](#) [B32922C3224K289](#) [B32922C3104M289](#) [B32922C3154M289](#)
[B32922C3224M289](#) [B32922C3334M289](#) [B32922D3334K289](#) [B32922C3474K289](#) [B32922C3474M289](#)
[B32923C3334M289](#) [B32923D3334K289](#) [B32923C3474K289](#) [B32923C3474M289](#) [B32923C3684K289](#)
[B32923C3105K289](#) [B32923C3105M289](#) [B32921C3103K189](#) [B32921C3223K189](#) [B32921C3333K189](#)
[B32921C3473K189](#) [B32921C3103M189](#) [B32921C3223M189](#) [B32921C3333M189](#) [B32921C3473M189](#)
[B32921C3683K189](#) [B32921C3683M189](#) [B32921C3104M189](#) [B32922C3333K189](#) [B32922C3473K189](#)
[B32922C3683K189](#) [B32922C3104K189](#) [B32922C3154K189](#) [B32922C3224K189](#) [B32922C3104M189](#)
[B32922C3154M189](#) [B32922C3224M189](#) [B32922C3334M189](#) [B32922D3334K189](#) [B32922C3474K189](#)
[B32922C3474M189](#) [B32922C3684M189](#) [B32923C3334M189](#) [B32923D3334K189](#) [B32923C3474K189](#)
[B32923C3474M189](#) [B32923C3684K189](#) [B32923C3684M189](#) [B32923C3105K189](#) [B32923C3105M189](#)
[B32924C3684K189](#) [B32924C3105K189](#) [B32924C3684M189](#) [B32924C3105M189](#) [B32924C3155K189](#)
[B32924C3155M189](#) [B32923C3224K289](#) [B32923C3224M289](#) [B32924C3565M000](#) [B32922C3684K189](#)
[B32926C3225K000](#) [B32921C3683K000](#) [B32926C3106K000](#) [B32924C3684M000](#) [B32923C3224K000](#)
[B32926C3335M000](#) [B32926C3825M000](#) [B32928C3306M000](#) [B32928C3256K000](#) [B32928C3256M000](#)
[B32928C3206M000](#) [B32926D3156K000](#) [B32926C3156M000](#) [B32926D3156M000](#) [B32928C3206K000](#)
[B32926C3395M000](#)

Компания «Life Electronics» занимается поставками электронных компонентов импортного и отечественного производства от производителей и со складов крупных дистрибьюторов Европы, Америки и Азии.

С конца 2013 года компания активно расширяет линейку поставок компонентов по направлению коаксиальный кабель, кварцевые генераторы и конденсаторы (керамические, пленочные, электролитические), за счёт заключения дистрибьюторских договоров

Мы предлагаем:

- Конкуренспособные цены и скидки постоянным клиентам.
- Специальные условия для постоянных клиентов.
- Подбор аналогов.
- Поставку компонентов в любых объемах, удовлетворяющих вашим потребностям.
- Приемлемые сроки поставки, возможна ускоренная поставка.
- Доставку товара в любую точку России и стран СНГ.
- Комплексную поставку.
- Работу по проектам и поставку образцов.
- Формирование склада под заказчика.
- Сертификаты соответствия на поставляемую продукцию (по желанию клиента).
- Тестирование поставляемой продукции.
- Поставку компонентов, требующих военную и космическую приемку.
- Входной контроль качества.
- Наличие сертификата ISO.

В составе нашей компании организован Конструкторский отдел, призванный помогать разработчикам, и инженерам.

Конструкторский отдел помогает осуществить:

- Регистрацию проекта у производителя компонентов.
- Техническую поддержку проекта.
- Защиту от снятия компонента с производства.
- Оценку стоимости проекта по компонентам.
- Изготовление тестовой платы монтаж и пусконаладочные работы.



Тел: +7 (812) 336 43 04 (многоканальный)
Email: org@lifeelectronics.ru