

## Features

- Attenuation: 0.5 dB Steps to 15.5 dB
- Low DC Power Consumption
- Integral TTL Driver
- 50 ohm Impedance
- Test Boards are Available
- Tape and Reel Packaging Available
- Lead-Free SOW-16 Package
- 100% Matte Tin Plating over Copper
- Halogen-Free “Green” Mold Compound
- 260°C Reflow Compatible
- RoHS\* Compliant Version of AT65-0283

## Description

M/A-COM's MAAD-007084-000100 is a GaAs FET 5-bit digital attenuator with integral TTL driver. Step size is 0.5 dB providing a 15.5 dB total attenuation range. This device is in a SOW-16 plastic surface mount package. The MAAD-007084-000100 is ideally suited for use where accuracy, fast speed, very low power consumption and low costs are required.

## Ordering Information

Part Number	Package
MAAD-007084-000100	Bulk Packaging
MAAD-007084-0001TR	1000 piece reel
MAAD-007084-0001TB	Sample Test Board

Note: Reference Application Note M513 for reel size information.

Note: Die quantity varies.

## Schematic with Off-Chip Components

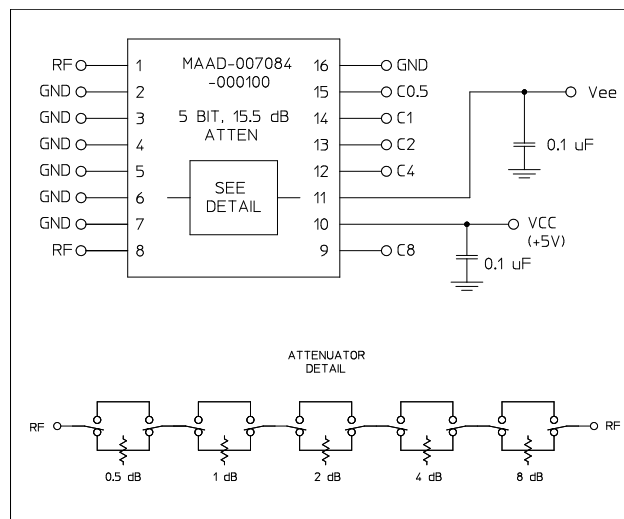

## Pin Configuration

Pin No.	Function	Pin No.	Function
1	RF	9	C8
2	GND	10	Vcc
3	GND	11	Vee
4	GND	12	C4
5	GND	13	C2
6	GND	14	C1
7	GND	15	C0.5
8	RF	16	GND

## Truth Table (Digital Attenuator)

C8	C4	C2	C1	C0.5	Attenuation
0	0	0	0	0	Loss, Reference
0	0	0	0	1	0.5 dB
0	0	0	1	0	1.0 dB
0	0	1	0	0	2.0 dB
0	1	0	0	0	4.0 dB
1	0	0	0	0	8.0 dB
1	1	1	1	1	15.5 dB

0 = TTL Low; 1 = TTL High

\* Restrictions on Hazardous Substances, European Union Directive 2002/95/EC.

## Digital Attenuator 15.5 dB, 5-Bit, TTL Driver, DC - 2.0 GHz

Rev. V3

### Electrical Specifications: $T_A = 25^\circ\text{C}$ , $Z_0 = 50\Omega$

Parameter	Test Conditions	Frequency	Units	Min	Typ	Max
Insertion Loss	—	DC - 1.0 GHz	dB	—	2.5	2.7
		DC - 2.0 GHz	dB	—	2.7	3.0
Attenuation Accuracy	Any Bit Any Combination of Bits	DC - 2.0 GHz	dB	—	—	$\pm(.3 +4\% \text{ of atten})$
		DC -2.0 GHz	dB	—	—	$\pm (.3 +6\% \text{ of atten})$
VSWR	Full Range	DC - 2.0 GHz	Ratio	—	1.5:1	2:1
Switching Speed <sup>1</sup>	50% Cntl to 90%/10% RF 10% to 90% or 90% to 10%	—	ns	—	75	150
		—	ns	—	20	50
1 dB Compression	—	50 MHz	dBm	—	+21	—
		0.5 - 2.0 GHz	dBm	—	+29	—
Input IP <sub>3</sub>	Two-tone inputs up to +5 dBm	50 MHz	dB	—	+35	—
		0.5-2.0 GHz	dB	—	+48	—
V <sub>CC</sub>	—	—	V	4.75	5.0	5.25
V <sub>EE</sub>	—	—	V	-8.0	-5.0	-4.75
V <sub>IL</sub> V <sub>IH</sub>	LOW-level input voltage HIGH-level input voltage	—	V	0.0	—	0.8
		—	V	2.0	—	5.0
I <sub>in</sub> (Input Leakage Current)	V <sub>in</sub> = V <sub>CC</sub> or GND	—	uA	-1.0	—	1.0
I <sub>CC</sub> (Quiescent Supply Current)	V <sub>cntrl</sub> = V <sub>CC</sub> or GND	—	uA	—	250	400
$\Delta I_{CC}^2$ (Additional Supply Current Per TTL Input Pin)	V <sub>CC</sub> = Max, V <sub>cntrl</sub> = V <sub>CC</sub> - 2.1 V	—	mA	—	—	1.0
I <sub>EE</sub>	V <sub>EE</sub> min to max, V <sub>in</sub> = V <sub>IL</sub> or V <sub>IH</sub>	—	mA	-1.0	-0.2	—

- Decoupling capacitors (.01  $\mu\text{F}$ ) are required on power supply lines.
- For calculating  $\Delta I_{CC}$ , the number of TTL input pins is 6.

### Absolute Maximum Ratings<sup>3,4</sup>

Parameter	Absolute Maximum
Max. Input Power 0.05 GHz 0.5 - 2.0 GHz	+27 dBm +34 dBm
V <sub>CC</sub>	$-0.5\text{V} \leq V_{CC} \leq +7.0\text{V}$
V <sub>EE</sub>	$-8.5\text{V} \leq V_{EE} \leq +0.5\text{V}$
V <sub>CC</sub> - V <sub>EE</sub>	$-0.5\text{V} \leq V_{CC} - V_{EE} \leq 14.5\text{V}$
V <sub>in</sub> <sup>5</sup>	$-0.5\text{V} \leq V_{in} \leq V_{CC} + 0.5\text{V}$
Operating Temperature	-40°C to +85°C
Storage Temperature	-65°C to +125°C

- Exceeding any one or combination of these limits may cause permanent damage to this device.
- MACOM does not recommend sustained operation near these survivability limits.
- Standard CMOS TTL interface, latch-up will occur if logic signal is applied prior to power supply.

### Handling Procedures

Please observe the following precautions to avoid damage:

### Static Sensitivity

Gallium Arsenide Integrated Circuits are sensitive to electrostatic discharge (ESD) and can be damaged by static electricity. Proper ESD control techniques should be used when handling these devices.

## Typical Performance Curves

### Insertion Loss

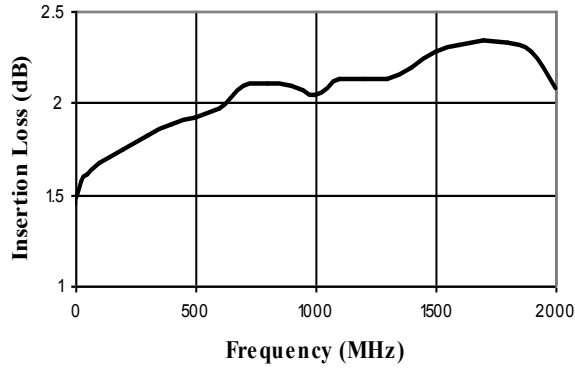

### Attenuation Accuracy 0.5, 1, 2, and 4 dB Bits

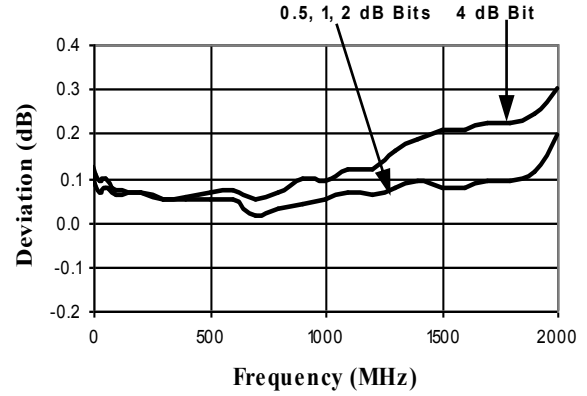

### Attenuation Accuracy 8 dB Bit and Max. Attenuation

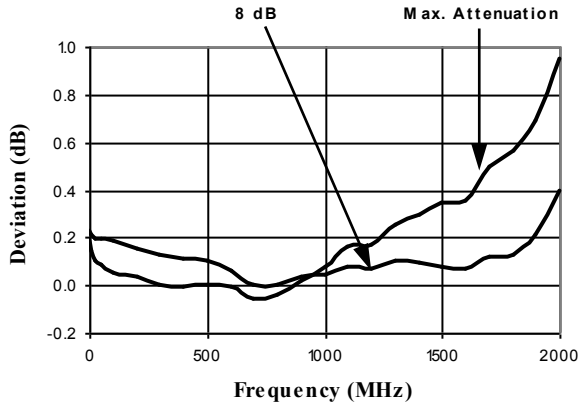

### VSWR @ Insertion Loss

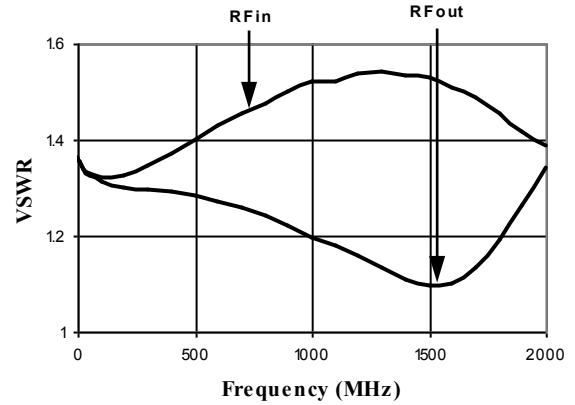

### VSWR RF OUT 0.5, 1, 2, and 4 dB Bits

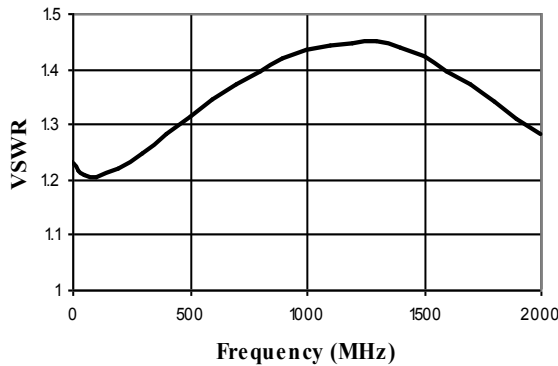

### VSWR RF IN 0.5, 1, 2, 4, 8 dB Bits and Max. Attenuation

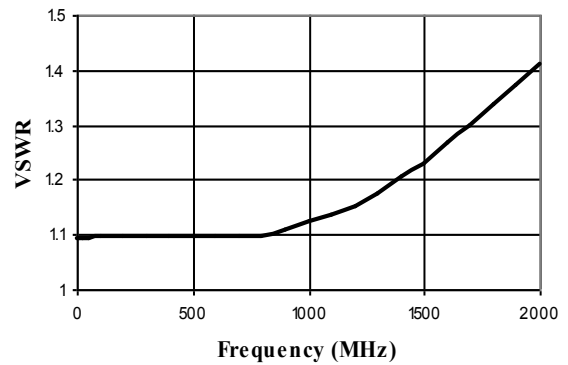

**Digital Attenuator**  
**15.5 dB, 5-Bit, TTL Driver, DC - 2.0 GHz**

Rev. V3

## Typical Performance Curves

*VSWR RF OUT 8 dB Bit and Max. Attenuation*

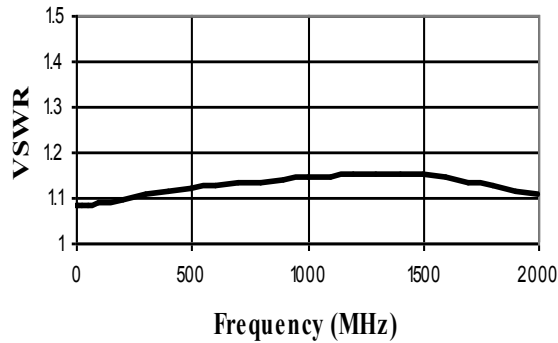

## Lead-Free, SOW-16<sup>†</sup>

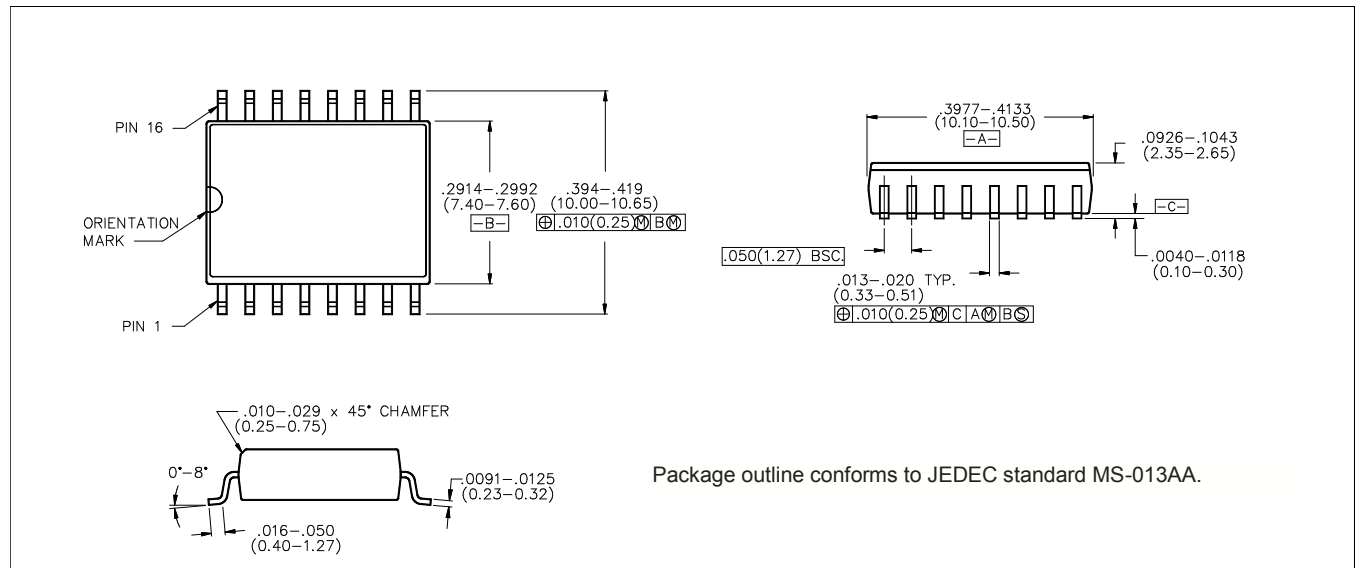

<sup>†</sup> Reference Application Note M538 for lead-free solder reflow recommendations.

M/A-COM Technology Solutions Inc. All rights reserved.

Information in this document is provided in connection with M/A-COM Technology Solutions Inc ("MACOM") products. These materials are provided by MACOM as a service to its customers and may be used for informational purposes only. Except as provided in MACOM's Terms and Conditions of Sale for such products or in any separate agreement related to this document, MACOM assumes no liability whatsoever. MACOM assumes no responsibility for errors or omissions in these materials. MACOM may make changes to specifications and product descriptions at any time, without notice. MACOM makes no commitment to update the information and shall have no responsibility whatsoever for conflicts or incompatibilities arising from future changes to its specifications and product descriptions. No license, express or implied, by estoppel or otherwise, to any intellectual property rights is granted by this document.

THESE MATERIALS ARE PROVIDED "AS IS" WITHOUT WARRANTY OF ANY KIND, EITHER EXPRESS OR IMPLIED, RELATING TO SALE AND/OR USE OF MACOM PRODUCTS INCLUDING LIABILITY OR WARRANTIES RELATING TO FITNESS FOR A PARTICULAR PURPOSE, CONSEQUENTIAL OR INCIDENTAL DAMAGES, MERCHANTABILITY, OR INFRINGEMENT OF ANY PATENT, COPYRIGHT OR OTHER INTELLECTUAL PROPERTY RIGHT. MACOM FURTHER DOES NOT WARRANT THE ACCURACY OR COMPLETENESS OF THE INFORMATION, TEXT, GRAPHICS OR OTHER ITEMS CONTAINED WITHIN THESE MATERIALS. MACOM SHALL NOT BE LIABLE FOR ANY SPECIAL, INDIRECT, INCIDENTAL, OR CONSEQUENTIAL DAMAGES, INCLUDING WITHOUT LIMITATION, LOST REVENUES OR LOST PROFITS, WHICH MAY RESULT FROM THE USE OF THESE MATERIALS.

MACOM products are not intended for use in medical, lifesaving or life sustaining applications. MACOM customers using or selling MACOM products for use in such applications do so at their own risk and agree to fully indemnify MACOM for any damages resulting from such improper use or sale.

Компания «Life Electronics» занимается поставками электронных компонентов импортного и отечественного производства от производителей и со складов крупных дистрибьюторов Европы, Америки и Азии.

С конца 2013 года компания активно расширяет линейку поставок компонентов по направлению коаксиальный кабель, кварцевые генераторы и конденсаторы (керамические, пленочные, электролитические), за счёт заключения дистрибьюторских договоров

Мы предлагаем:

- Конкурентоспособные цены и скидки постоянным клиентам.
- Специальные условия для постоянных клиентов.
- Подбор аналогов.
- Поставку компонентов в любых объемах, удовлетворяющих вашим потребностям.
- Приемлемые сроки поставки, возможна ускоренная поставка.
- Доставку товара в любую точку России и стран СНГ.
- Комплексную поставку.
- Работу по проектам и поставку образцов.
- Формирование склада под заказчика.
- Сертификаты соответствия на поставляемую продукцию (по желанию клиента).
- Тестирование поставляемой продукции.
- Поставку компонентов, требующих военную и космическую приемку.
- Входной контроль качества.
- Наличие сертификата ISO.

В составе нашей компании организован Конструкторский отдел, призванный помогать разработчикам, и инженерам.

Конструкторский отдел помогает осуществить:

- Регистрацию проекта у производителя компонентов.
- Техническую поддержку проекта.
- Защиту от снятия компонента с производства.
- Оценку стоимости проекта по компонентам.
- Изготовление тестовой платы монтаж и пусконаладочные работы.



Тел: +7 (812) 336 43 04 (многоканальный)

Email: [org@lifeelectronics.ru](mailto:org@lifeelectronics.ru)