

### Product Overview

The Qorvo T1G4020036-FL is a 2 x 200 W ( $P_{3dB}$ ) discrete GaN on SiC HEMT which operates from DC to 3.5 GHz. The device is in an industry standard air cavity package and is ideally suited for IFF, avionics, military and civilian radar, and test instrumentation. The device can support both pulsed and linear operations.

Lead-free and ROHS compliant

Evaluation boards are available upon request.



4-lead NI-650 Package (Eared)

### Functional Block Diagram

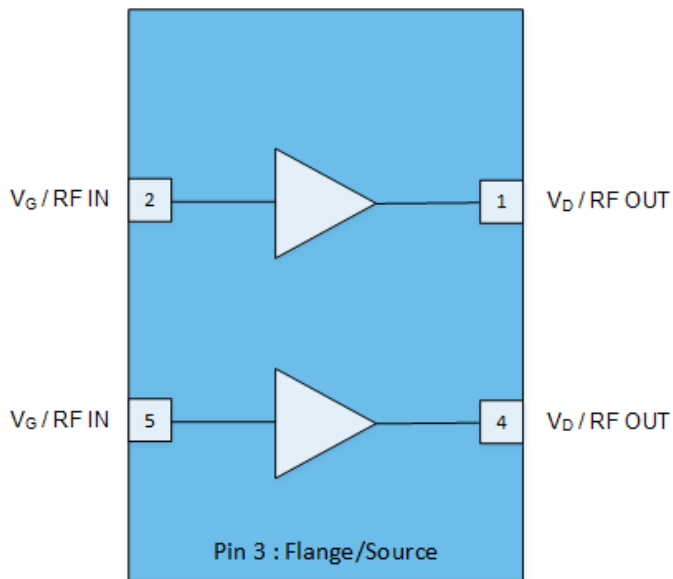

### Key Features

- Frequency: DC to 3.5 GHz
  - Output Power ( $P_{3dB}$ )<sup>1</sup>: 200 W
  - Linear Gain<sup>1</sup>: 18.1 dB
  - Typical PAE<sub>3dB</sub><sup>1</sup>: 67.6%
  - Operating Voltage: 50 V
  - CW and Pulse capable
- Note 1: @ 2.8 GHz Load Pull (Half of device)

### Applications

- Military and civilian radar
- Professional and military radio communications
- Test instrumentation
- Wideband or narrowband amplifiers
- Jammers

### Ordering info

Part No.	ECCN	Description
T1G4020036-FL	3A001.b.3.b	DC–3.5 GHz, 50 V, 200 W GaN RF Transistor, Eared
T1G4020036-FL-EVB1	EAR99	2.9–3.3 GHz EVB



# T1G4020036-FL

DC – 3.5 GHz, 50 V, 2 x 200 W GaN RF Transistor

## Absolute Maximum Ratings <sup>1</sup>

Parameter	Rating	Units
Breakdown Voltage, $V_{BDG}$	+145	V
Gate Voltage Range, $V_G$	-7 to +2	V
Drain Current, $I_{D_{MAX}}$	24	A
Gate Current Range, $I_G$	See pg. 14	mA
Power Dissipation, CW, $P_{DISS}$	236	W
RF Input Power, CW, $T = 25^\circ\text{C}$	+47.5	dBm
Channel Temperature, $T_{CH}$	275	$^\circ\text{C}$
Mounting Temperature (30 Seconds)	320	$^\circ\text{C}$
Storage Temperature	-65 to +150	$^\circ\text{C}$

Notes:

1. Operation of this device outside the parameter ranges given above may cause permanent damage.

## Recommended Operating Conditions <sup>1</sup>

Parameter	Min	Typ	Max	Units
Operating Temp. Range	-40	+25	+85	$^\circ\text{C}$
Drain Voltage Range, $V_D$	+32	+50	+55	V
Drain Bias Current, $I_{DQ}$		520		mA
Drain Current, $I_D^4$	-	12	-	A
Gate Voltage, $V_G^3$	-	-2.8	-	V
Channel Temperature ( $T_{CH}$ )	-	-	250	$^\circ\text{C}$
Power Dissipation ( $P_D$ ) <sup>2,4</sup>	-	-	374	W
Power Dissipation ( $P_D$ ), CW <sup>2</sup>	-	-	211	W

Notes:

1. Electrical performance is measured under conditions noted in the electrical specifications table. Specifications are not guaranteed over all recommended operating conditions.
2. Package base at  $85^\circ\text{C}$
3. To be adjusted to desired  $I_{DQ}$
4. Pulsed, 100us PW, 20% DC

## Measured Load Pull Performance – Power Tuned <sup>1</sup>

Parameter	Typical Values				Units
	2.4	2.8	3.2	3.6	
Frequency, F	2.4	2.8	3.2	3.6	GHz
Output Power at 3dB compression, $P_{3dB}$	53.1	53.0	52.8	52.9	dBm
Power Added Efficiency at 3dB compression, $PAE_{3dB}$	54.1	54.7	57.5	54.9	%
Gain at 3dB compression, $G_{3dB}$	15.6	15.1	15.9	16.0	dB

Notes:

1. Test conditions unless otherwise noted:  $T_A = 25^\circ\text{C}$ ,  $V_D = 50\text{ V}$ ,  $I_{DQ} = 260\text{ mA}$  (half device)
2. Pulsed, 100 us Pulse Width, 10% Duty Cycle.

## Measured Load Pull Performance – Efficiency Tuned <sup>1</sup>

Parameter	Typical Values				Units
	2.4	2.8	3.2	3.6	
Frequency, F	2.4	2.8	3.2	3.6	GHz
Output Power at 3dB compression, $P_{3dB}$	50.1	50.2	50.5	50.5	dBm
Power Added Efficiency at 3dB compression, $PAE_{3dB}$	72.9	67.6	66.5	65.8	%
Gain at 3dB compression, $G_{3dB}$	17.5	18.4	17.4	18.1	dB

Notes:

1. Test conditions unless otherwise noted:  $T_A = 25^\circ\text{C}$ ,  $V_D = 50\text{ V}$ ,  $I_{DQ} = 260\text{ mA}$  (half device)
2. Pulsed, 100 us Pulse Width, 10% Duty Cycle.

### RF Characterization – 2.9 – 3.3 GHz EVB Performance at 2.9 GHz <sup>1</sup>

Parameter	Min	Typ	Max	Units
Linear Gain, $G_{LIN}$	–	16.1	–	dB
Output Power at 3dB compression point, P3dB	162	244	–	W
Drain Efficiency at 3dB compression point, DEFF3dB	–	52.0	–	%
Gain at 3dB compression point, G3dB	12.0	13.1	–	dB

Notes:

1.  $V_D = +36\text{ V}$ ,  $I_{DQ} = 520\text{ mA}$  (combined), Temp =  $+25\text{ }^\circ\text{C}$ , Pulse Width = 100 us, Duty Cycle = 20%

### RF Characterization – Mismatch Ruggedness at 2.9 GHz <sup>1, 2, 3</sup>

Symbol	Parameter	dB Compression	Typical
VSWR	Impedance Mismatch Ruggedness	3	10:1

Notes:

1. Test conditions unless otherwise noted:  $T_A = 25\text{ }^\circ\text{C}$ ,  $V_D = 36\text{ V}$ ,  $I_{DQ} = 520\text{ mA}$  (combined)
2. Input drive power is determined at pulsed 3dB compression under matched condition at EVB output connector.
3. Pulse: 100us, 20% Duty cycle.

### Measured Load-Pull Smith Charts 1, 2, 3

Notes:

1. Test Conditions:  $V_D = 50\text{ V}$ ,  $I_{DQ} = 260\text{ mA}$ , 100 us Pulse Width, 10% Duty Cycle, Temp = 25°C.
2. The performance shown below is for only half of the device out of the two independent amplification paths.
3. See page 15 for load pull reference planes where the performance was measured.

### 2.4GHz, Load-pull

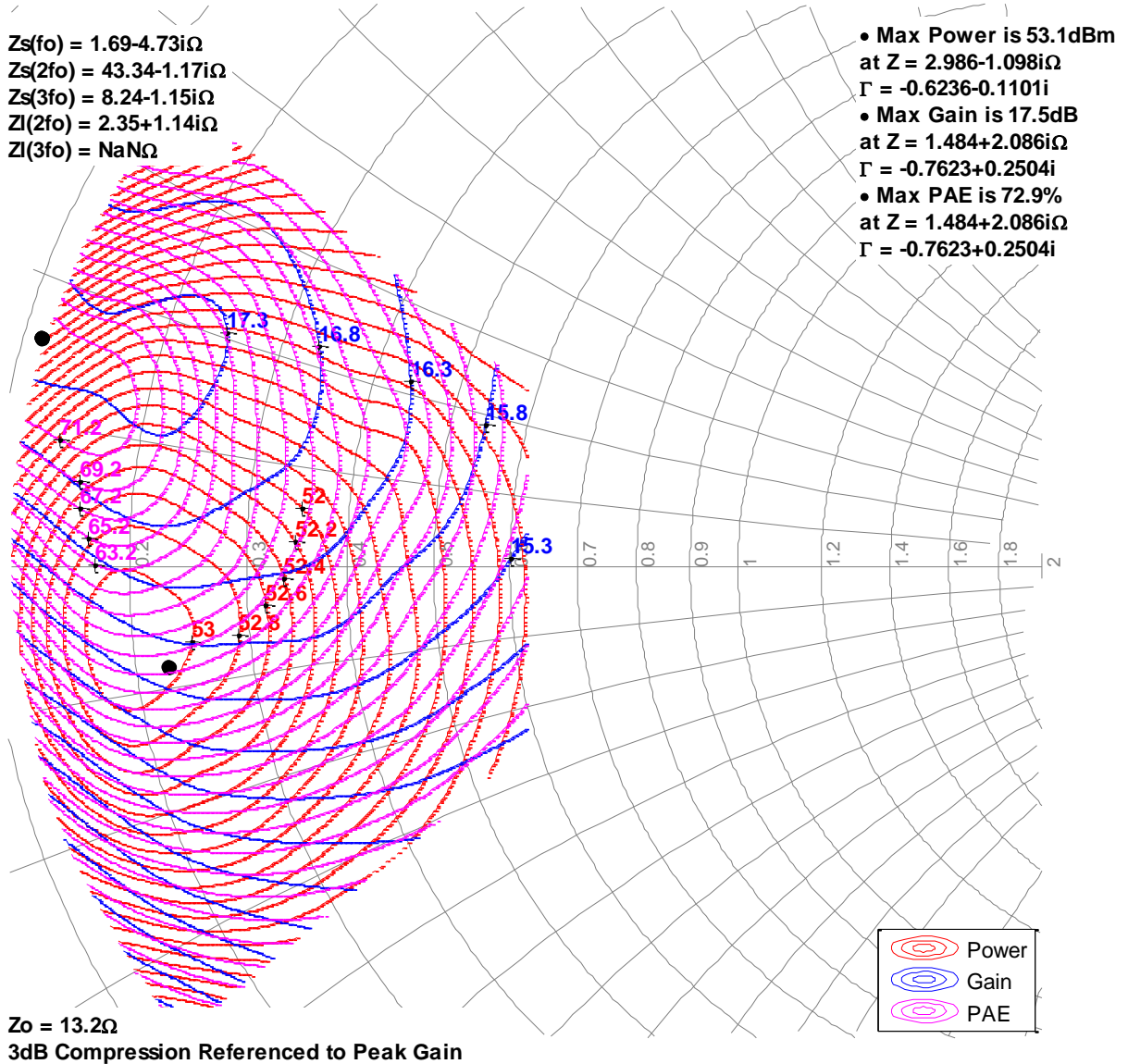

Measured Load-Pull Smith Charts 1, 2, 3

Notes:

1. Test Conditions:  $V_D = 50\text{ V}$ ,  $I_{DQ} = 260\text{ mA}$ , 100 us Pulse Width, 10% Duty Cycle, Temp = 25°C.
2. The performance shown below is for only half of the device out of the two independent amplification paths.
3. See page 15 for load pull reference planes where the performance was measured.

2.8GHz, Load-pull

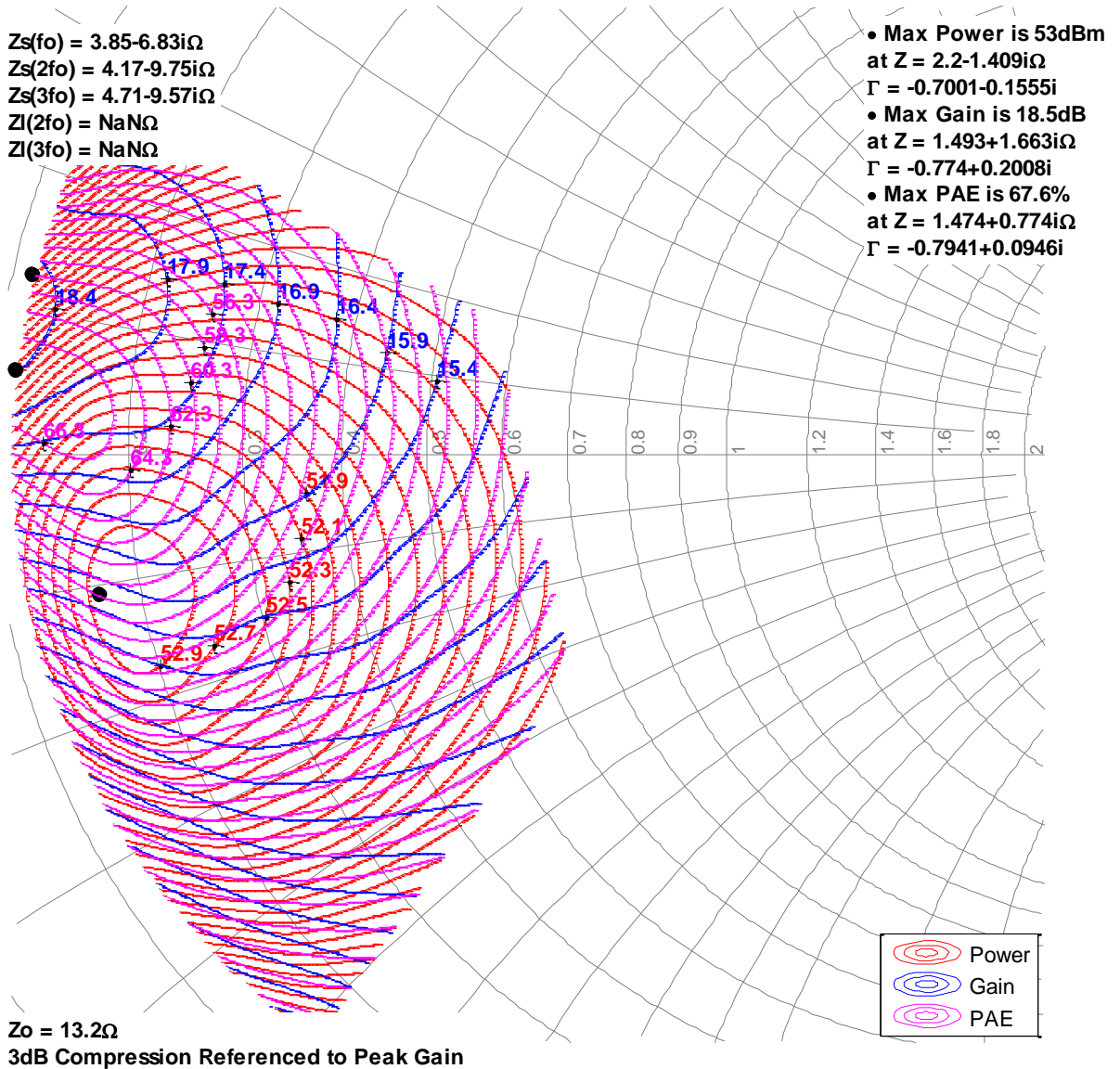

Measured Load-Pull Smith Charts 1, 2, 3

Notes:

1. Test Conditions:  $V_D = 50\text{ V}$ ,  $I_{DQ} = 260\text{ mA}$ , 100 us Pulse Width, 10% Duty Cycle, Temp = 25°C.
2. The performance shown below is for only half of the device out of the two independent amplification paths.
3. See page 15 for load pull reference planes where the performance was measured.

3.2GHz, Load-pull

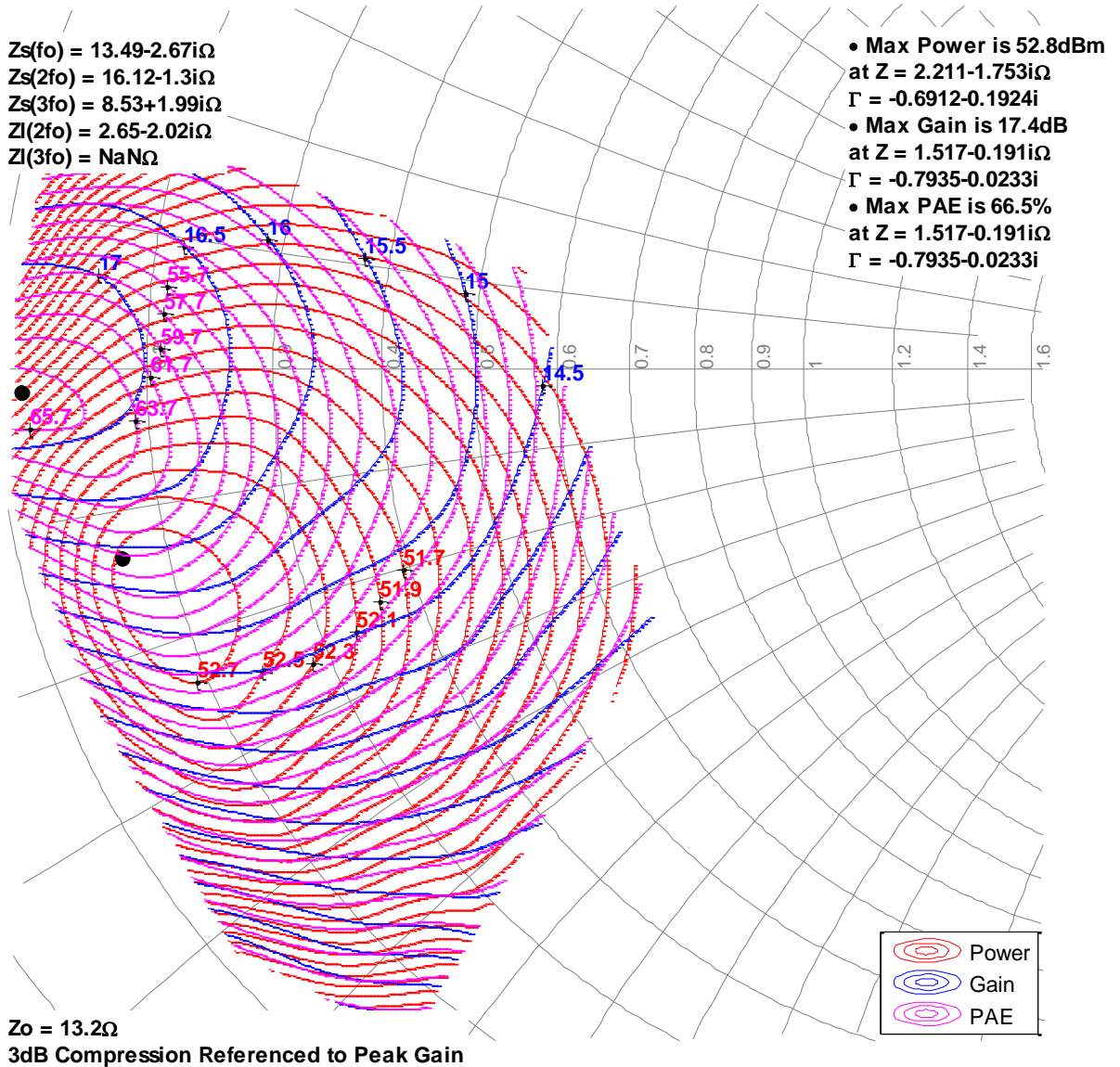

### Measured Load-Pull Smith Charts 1, 2, 3

Notes:

1. Test Conditions:  $V_D = 50\text{ V}$ ,  $I_{DQ} = 260\text{ mA}$ , 100 us Pulse Width, 10% Duty Cycle, Temp = 25°C.
2. The performance shown below is for only half of the device out of the two independent amplification paths.
3. See page 15 for load pull reference planes where the performance was measured.

### 3.6GHz, Load-pull

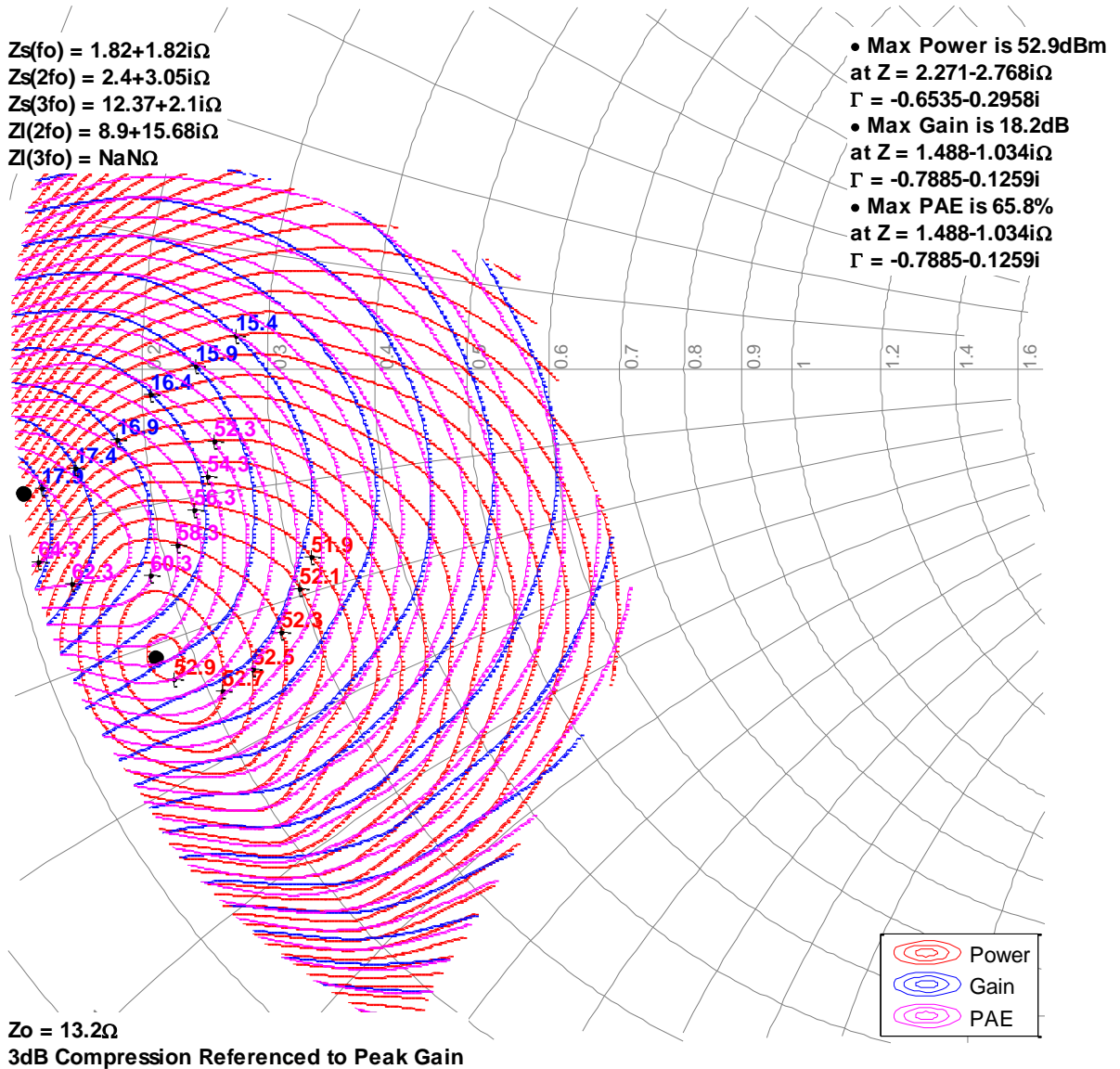

### Typical Measured Performance – Load-Pull Drive-up <sup>1,2</sup>

Notes:

1. Test Conditions:  $V_D = 50\text{ V}$ ,  $I_{DQ} = 260\text{ mA}$ , 100 us Pulse Width, 10% Duty Cycle, Temp = 25°C.
2. The performance shown below is for only half of the device out of the two independent amplification paths.
3. See page 15 for load pull reference planes where the performance was measured.

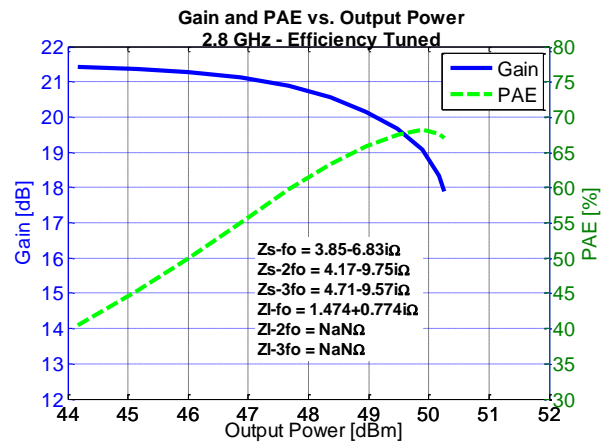
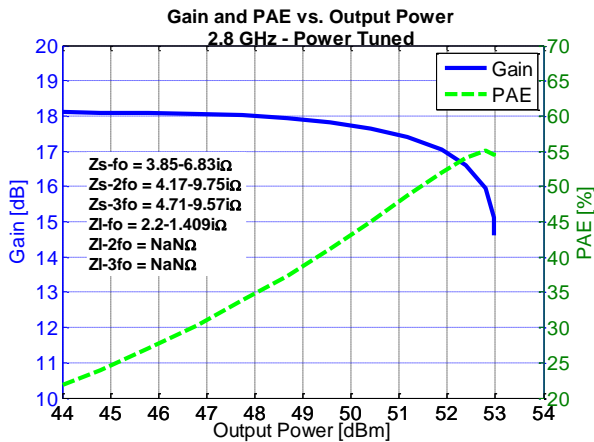
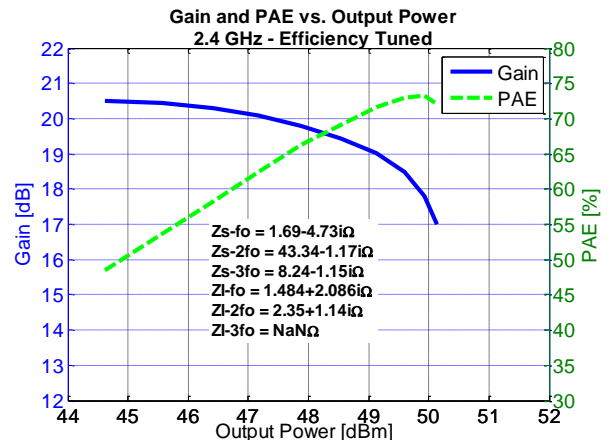
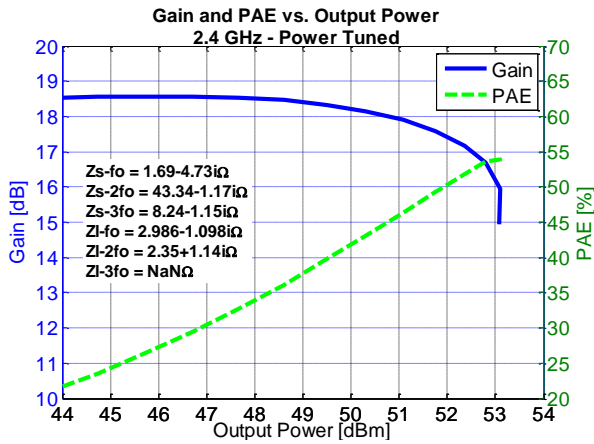



### Typical Measured Performance – Load-Pull Drive-up <sup>1,2</sup>

Notes:

1. Test Conditions:  $V_D = 50\text{ V}$ ,  $I_{DQ} = 260\text{ mA}$ , 100 us Pulse Width, 10% Duty Cycle, Temp = 25°C.
2. The performance shown below is for only half of the device out of the two independent amplification paths.
3. See page 15 for load pull reference planes where the performance was measured.

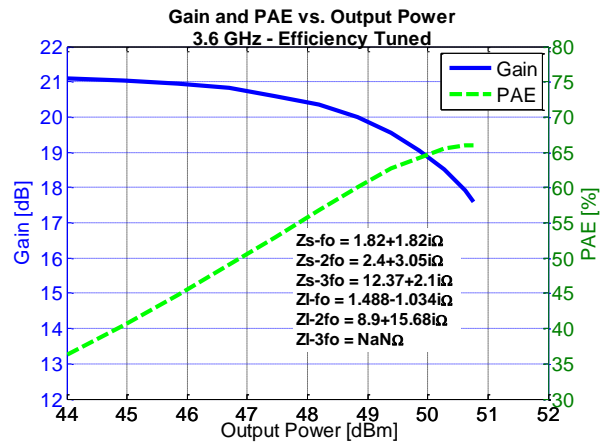
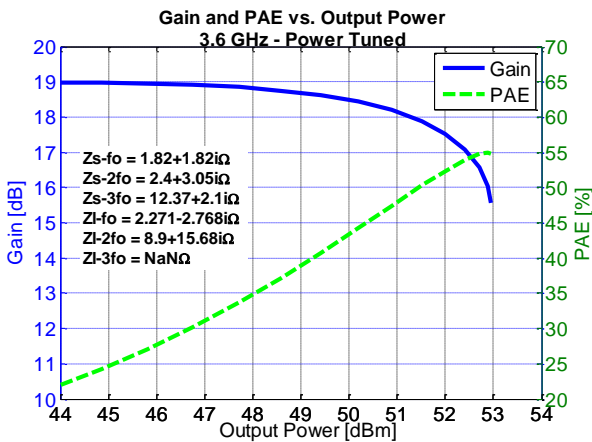
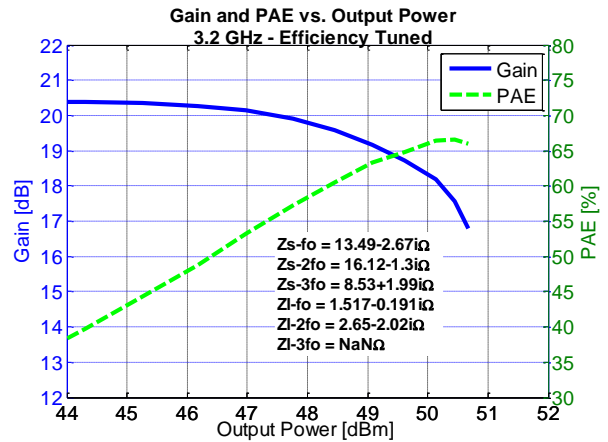
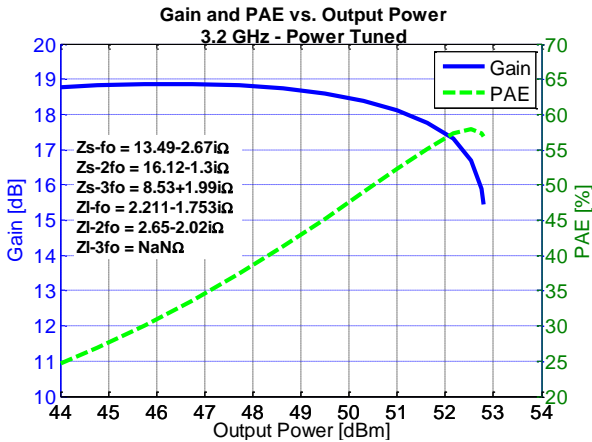

### Power Driveup Performance Over Temperatures Of 2.9 – 3.3 GHz EVB <sup>1</sup>

Notes:

1. Test Conditions:  $V_D = 36\text{ V}$ ,  $I_{DQ} = 520\text{ mA}$ , 100 us Pulse Width, 20% Duty Cycle.

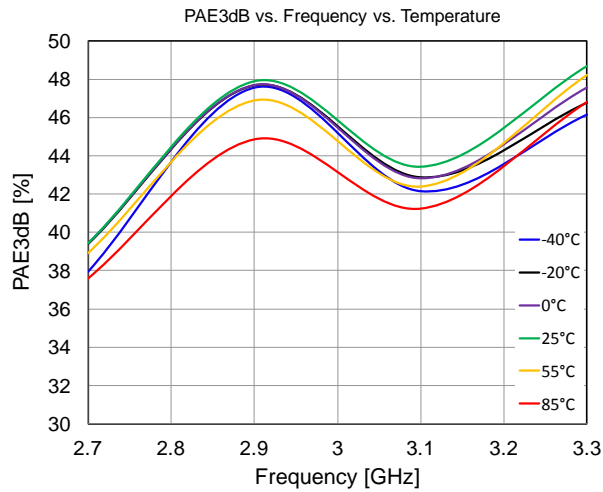
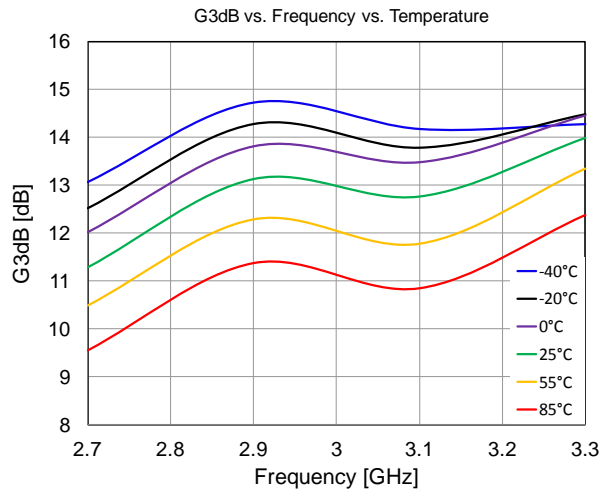
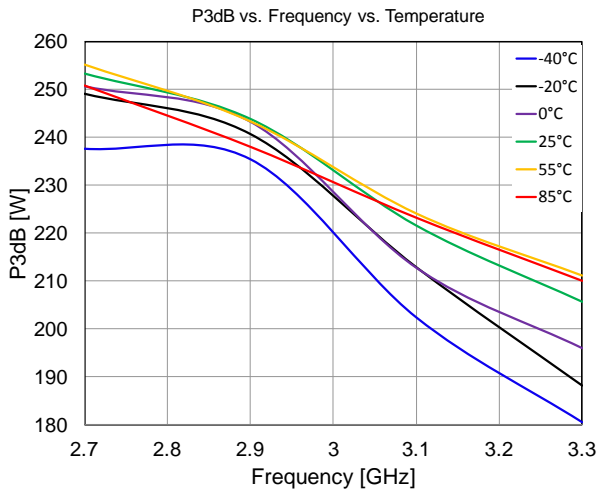

### Power Driveup Performance At 25°C Of 2.9 – 3.3 GHz EVB <sup>1</sup>

Notes:

1. Test Conditions:  $V_D = 36\text{ V}$ ,  $I_{DQ} = 520\text{ mA}$ , 20 us Pulse Width, 20% Duty Cycle.

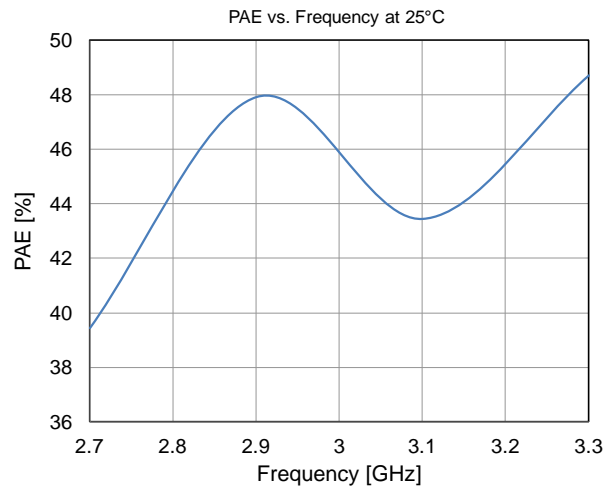
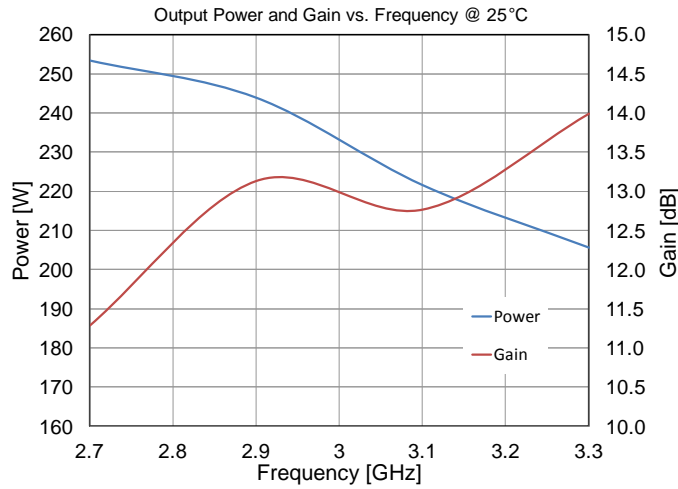

### Thermal and Reliability Information

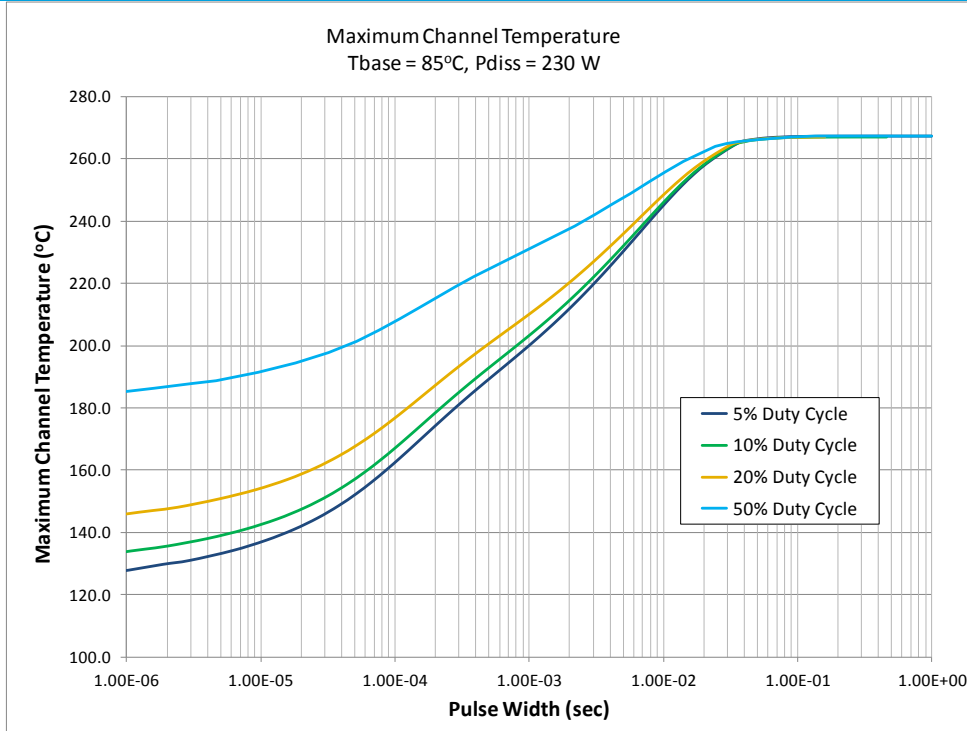

Parameter	Conditions	Values	Units
Thermal Resistance, FEA ( $\theta_{JC}$ ) <sup>(1)(3)</sup>	85 °C Case P <sub>diss</sub> = 211 W CW	0.78	°C/W
Peak Channel Temperature, FEA (T <sub>CH</sub> ) <sup>(1)</sup>		250	°C
Median Lifetime, FEA (T <sub>M</sub> ) <sup>(1)</sup>		1.0E6	Hrs
Peak Channel Temperature, IR <sup>(2)</sup>		189 <sup>(2)</sup>	°C
Thermal Resistance, FEA ( $\theta_{JC}$ ) <sup>(1)(3)</sup>	85 °C Case P <sub>diss</sub> = 230.4 W Pulse: 100 us PW, 20% DC	0.40	°C/W
Peak Channel Temperature, FEA (T <sub>CH</sub> ) <sup>(1)</sup>		177	°C
Median Lifetime, FEA (T <sub>M</sub> ) <sup>(1)</sup>		1.5E9	Hrs
Peak Channel Temperature, IR <sup>(2)</sup>		147 <sup>(2)</sup>	°C
Thermal Resistance, FEA ( $\theta_{JC}$ ) <sup>(1)(3)</sup>	85 °C Case P <sub>diss</sub> = 230.4 W Pulse: 100 us PW, 10% DC	0.36	°C/W
Peak Channel Temperature, FEA (T <sub>CH</sub> ) <sup>(1)</sup>		168	°C
Median Lifetime, FEA (T <sub>M</sub> ) <sup>(1)</sup>		7.0E9	Hrs
Peak Channel Temperature, IR <sup>(2)</sup>		141 <sup>(2)</sup>	°C
Thermal Resistance, FEA ( $\theta_{JC}$ ) <sup>(1)(3)</sup>	85 °C Case P <sub>diss</sub> = 230.4 W Pulse: 300 us PW, 20% DC	0.47	°C/W
Peak Channel Temperature, FEA (T <sub>CH</sub> ) <sup>(1)</sup>		194	°C
Median Lifetime, FEA (T <sub>M</sub> ) <sup>(1)</sup>		3.5E8	Hrs
Peak Channel Temperature, IR <sup>(2)</sup>		157 <sup>(2)</sup>	°C
Thermal Resistance, FEA ( $\theta_{JC}$ ) <sup>(1)(3)</sup>	85 °C Case P <sub>diss</sub> = 230.4 W Pulse: 300 us PW, 10% DC	0.43	°C/W
Peak Channel Temperature, FEA (T <sub>CH</sub> ) <sup>(1)</sup>		185	°C
Median Lifetime, FEA (T <sub>M</sub> ) <sup>(1)</sup>		1.7E9	Hrs
Peak Channel Temperature, IR <sup>(2)</sup>		152 <sup>(2)</sup>	°C

Notes:

1. Finite Element Analysis (FEA) thermal values shall be used to determine performance and reliability. Unless otherwise noted, all thermal references are FEA.
2. Infrared (IR) thermal values are for reference only and can not be used to determine performance or reliability.
3. Thermal resistance measured to backside of package.

Median Lifetime <sup>1,2</sup>

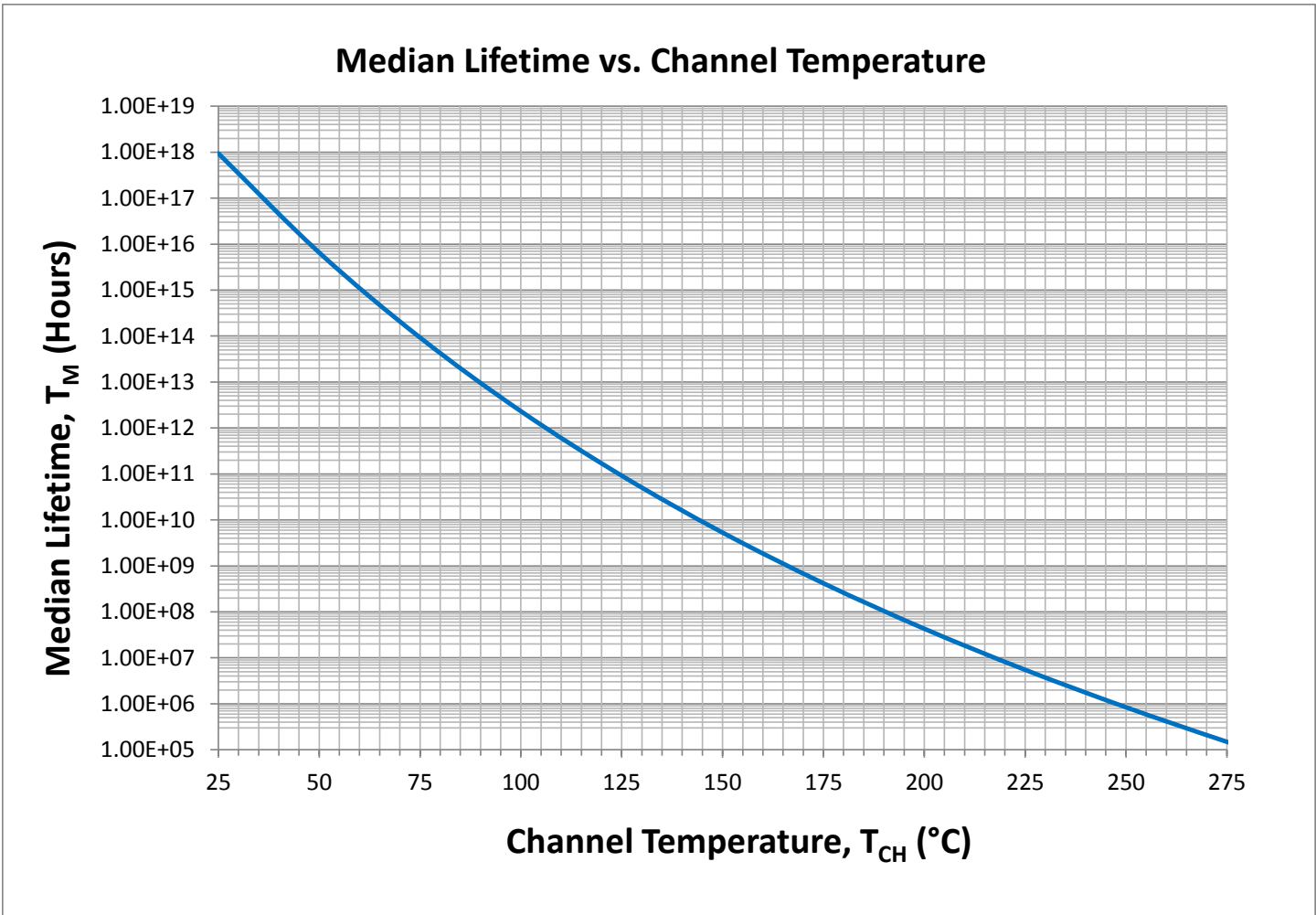

Notes:

1. Test Conditions:  $V_D = +50$  V; Failure Criteria = 10% reduction in  $I_{D\_MAX}$  during DC Life Testing.
2. For pulsed signals, average lifetime is average lifetime at maximum channel temperature divided by duty cycle.

Maximum Gate Current

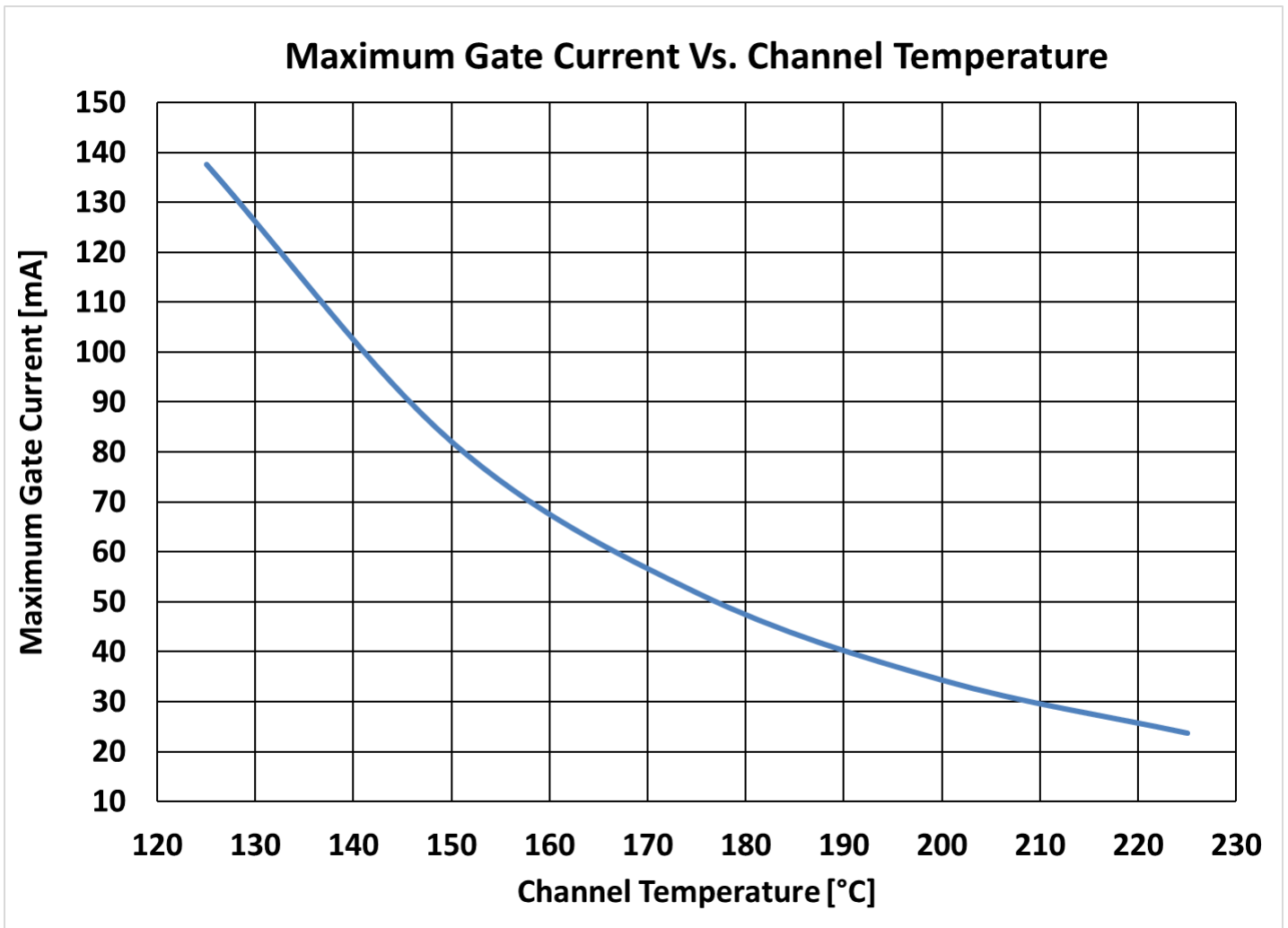

## Pin Configuration and Description <sup>1</sup>

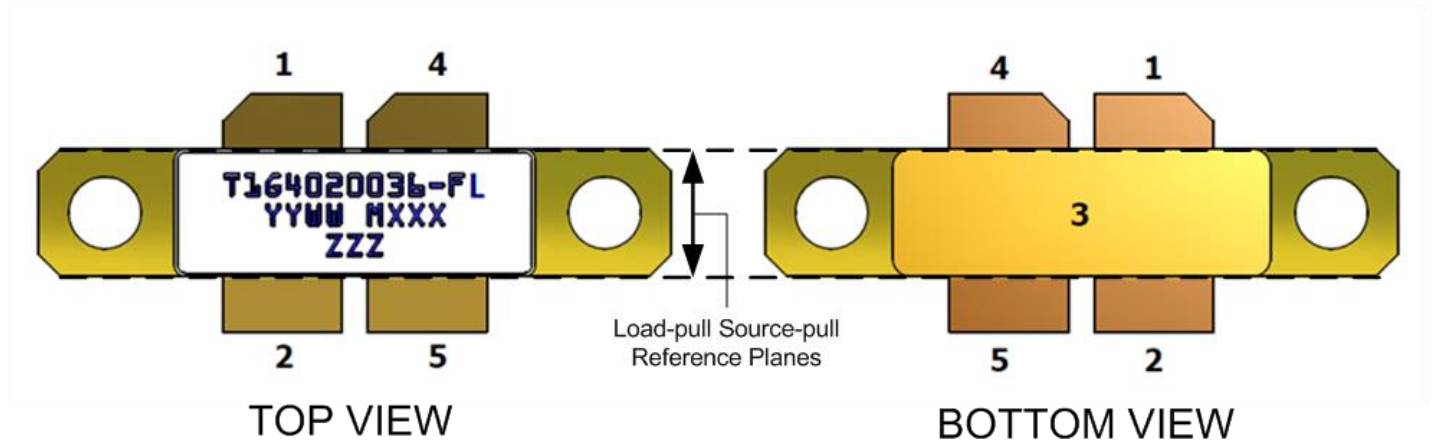

**Note:**

- The T1G4020036-FS will be marked with the “20036” designator and a lot code marked below the part designator. The “YY” represents the last two digits of the calendar year the part was manufactured, the “WW” is the work week of the assembly lot start, the “MXXX” is the production lot number, and the “ZZZ” is an auto-generated serial number.

Pin	Symbol	Description
2, 5	RF IN / $V_G$	Gate
1, 4	RF OUT / $V_D$	Drain
3	Source	Source / Ground / Backside of part

Mechanical Drawing <sup>1</sup>

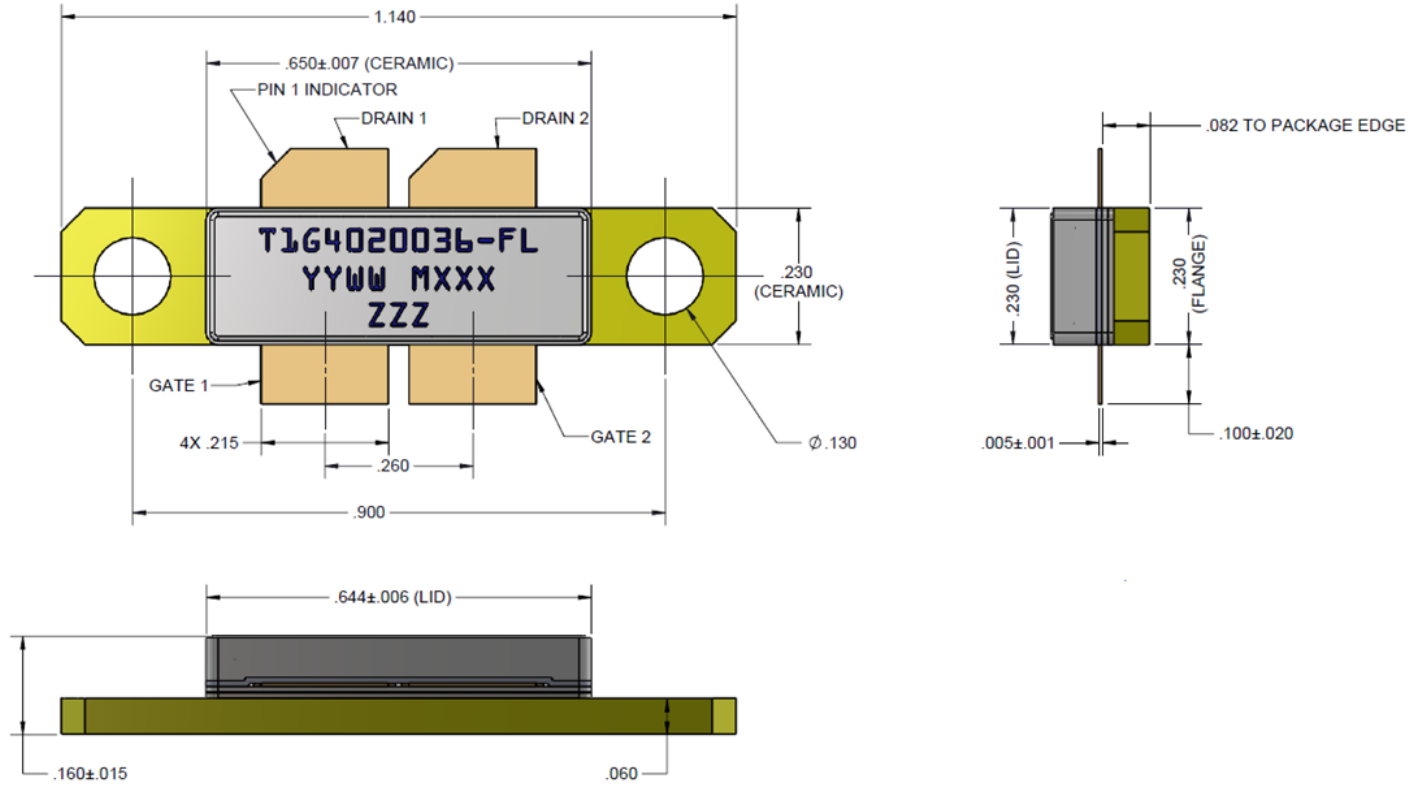

Note:

- 1- All dimensions are in inches. Dimension tolerance is ± 0.005 mil, unless noted otherwise.



### 2.9 – 3.3 GHz Application Circuit - Schematic

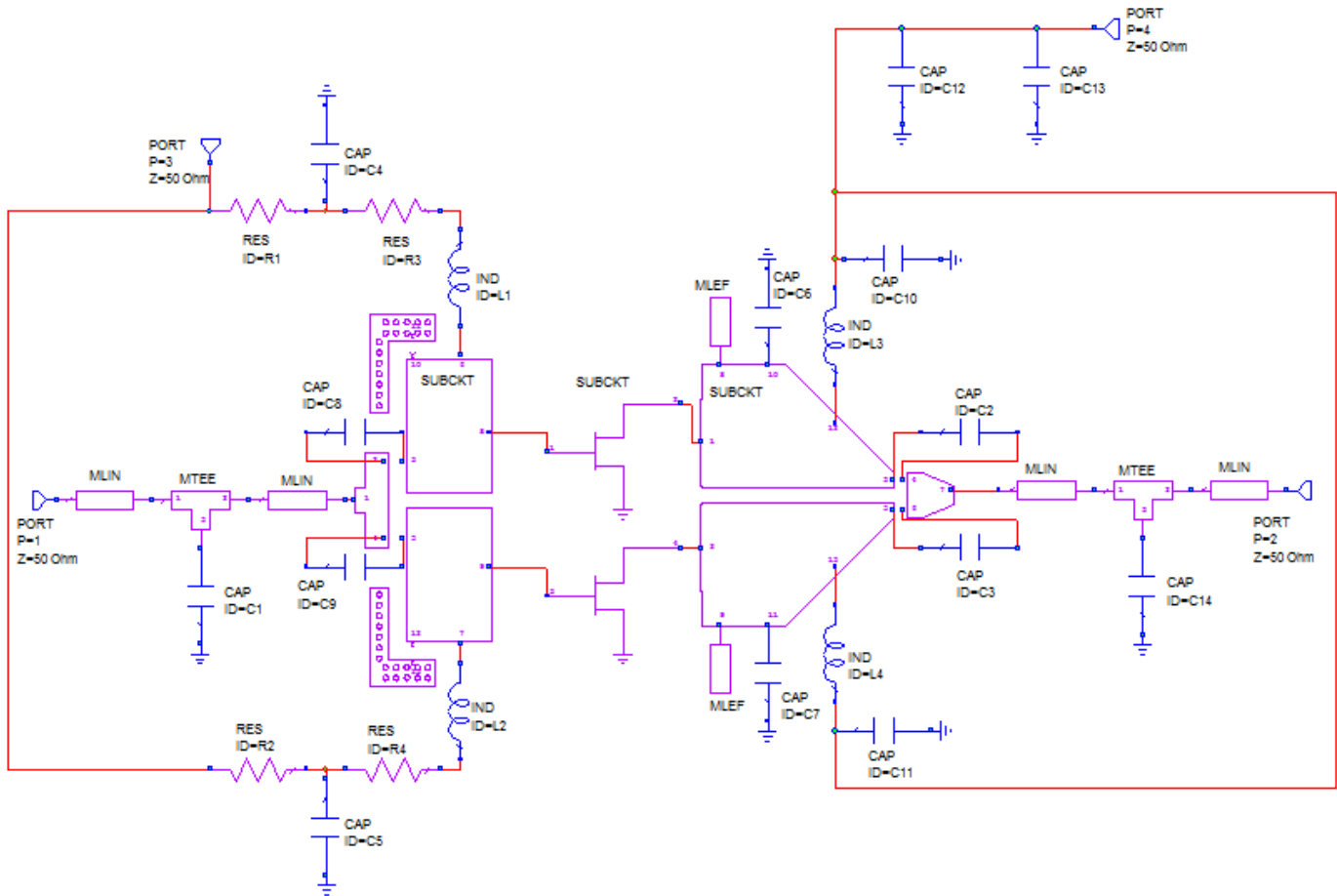

Bias-up Procedure	Bias-down Procedure
1. Set $V_G$ to -5 V.	1. Turn off RF signal.
2. Set $I_D$ current limit to 4 A.	2. Turn off $V_D$
3. Apply 36 V $V_D$ .	3. Wait 2 seconds to allow drain capacitor to discharge.
4. Slowly adjust $V_G$ until $I_D$ is set to 520 mA.	4. Turn off $V_G$
5. Apply RF.	

## 2.9 – 3.3 GHz Application Circuit - Layout

PCB material is RO4350B 0.020" thick.

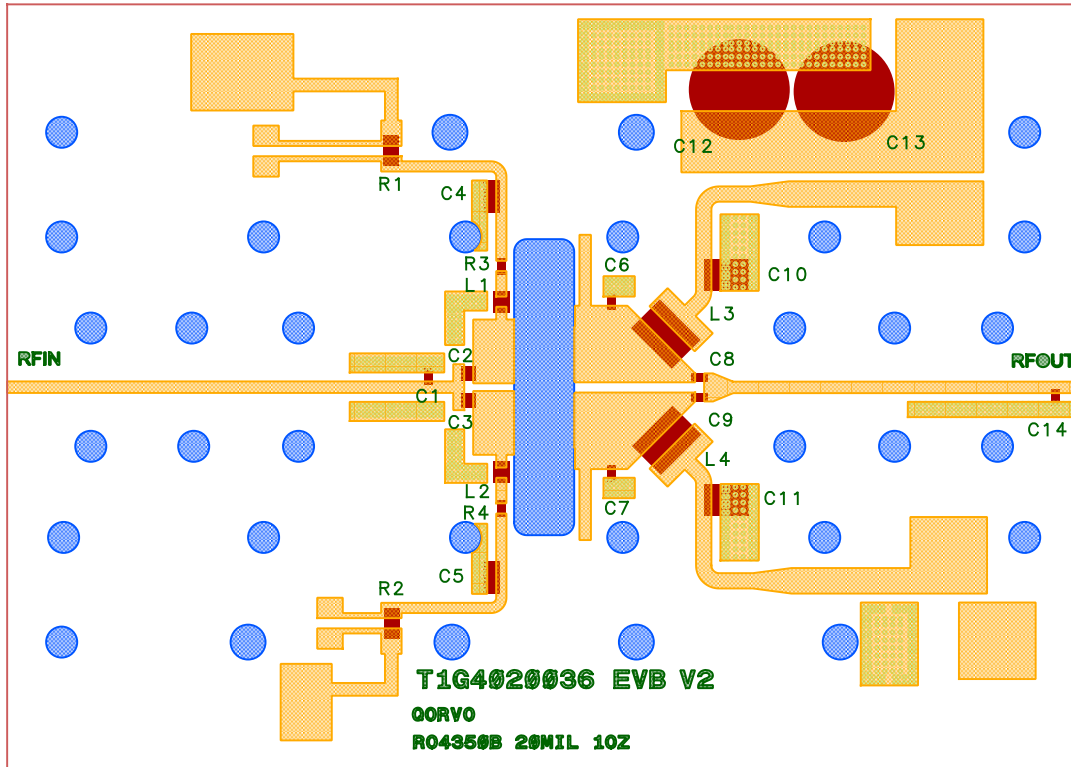

## 2.9 – 3.3 GHz Application Circuit – Bill of Material

Reference Design	Value	Qty	Manufacturer	Part Number
C4, C5	10uF, 6.3V	2	TDK	C1632X5R0J106M130AC
C10, C11	1uF, 100V	2	AVX	18121C105KAT2A
C12, C13	220uF, 50V	2	United Chemi-Con	EMVY500ADA221MJA0G
C2, C3	2.7pF	2	ATC	600F2R7AT250X
C8, C9	5.6pF	2	ATC	600S5R6AT250X
C1	1.6pF	1	ATC	600S1R6AT250X
C6, C7	0.5pF	2	ATC	600S0R5AT250X
C14	0.8pF	1	ATC	600S0R8AT250X
R3, R4	10Ohms	2	Vishay	CRCW060310R0FKEA
R1, R2	0.001Ohms	2	Stackpole Electronics	CSNL1206FT1L00
L1, L2	22nH	2	Coilcraft	0805CS-220X_E_
L3, L4	6.6nH	2	Coilcraft	GA3093-AL_
Connectors	SMA	2	Gigalane	1101055

Recommended Solder Temperature Profile

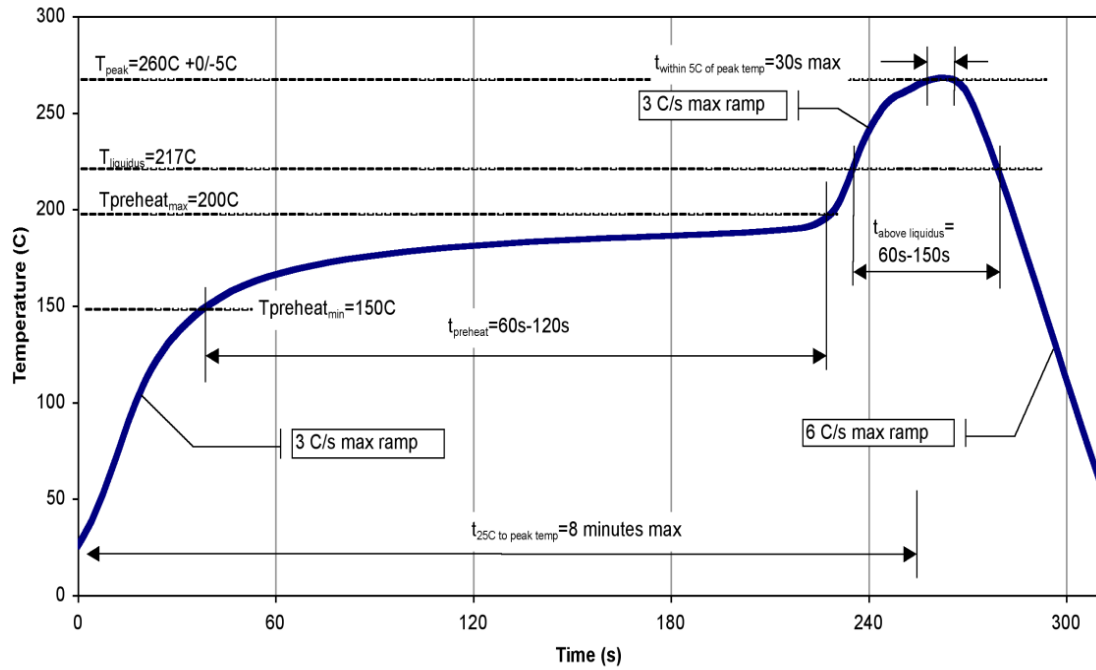

### Handling Precautions

Parameter	Rating	Standard
ESD – Human Body Model (HBM)	Class 1B	JESD22-A114
ESD – Charged Device Model (CDM)	Class C3	JESD22-C101
MSL – Moisture Sensitivity Level	MSL3	IPC/JEDEC J-STD-020 (260°C Convection reflow)



Caution!  
ESD-Sensitive Device

### Solderability

Compatible with both lead-free (260°C max. reflow temp.) and tin/lead (245°C max. reflow temp.) soldering processes. Solder profiles available upon request.

Contact plating: NiAu

### RoHS Compliance

This part is compliant with 2011/65/EU RoHS directive (Restrictions on the Use of Certain Hazardous Substances in Electrical and Electronic Equipment) as amended by Directive 2015/863/EU.

This product also has the following attributes:

- Lead Free
- Halogen Free (Chlorine, Bromine)
- Antimony Free
- TBBP-A (C<sub>15</sub>H<sub>12</sub>Br<sub>4</sub>O<sub>2</sub>) Free
- PFOS Free
- SVHC Free



### Contact Information

For the latest specifications, additional product information, worldwide sales and distribution locations, and information about Qorvo:

**Web:** [www.Qorvo.com](http://www.Qorvo.com)  
**Email:** [info-sales@qorvo.com](mailto:info-sales@qorvo.com)

**Tel:** +1.972.994.8465  
**Fax:** +1.972.994.8504

For technical questions and application information: **Email:** [info-products@qorvo.com](mailto:info-products@qorvo.com)

### Important Notice

The information contained herein is believed to be reliable; however, Qorvo makes no warranties regarding the information contained herein and assumes no responsibility or liability whatsoever for the use of the information contained herein. All information contained herein is subject to change without notice. Customers should obtain and verify the latest relevant information before placing orders for Qorvo products. The information contained herein or any use of such information does not grant, explicitly or implicitly, to any party any patent rights, licenses, or any other intellectual property rights, whether with regard to such information itself or anything described by such information. **THIS INFORMATION DOES NOT CONSTITUTE A WARRANTY WITH RESPECT TO THE PRODUCTS DESCRIBED HEREIN, AND QORVO HEREBY DISCLAIMS ANY AND ALL WARRANTIES WITH RESPECT TO SUCH PRODUCTS WHETHER EXPRESS OR IMPLIED BY LAW, COURSE OF DEALING, COURSE OF PERFORMANCE, USAGE OF TRADE OR OTHERWISE, INCLUDING THE IMPLIED WARRANTIES OF MERCHANTABILITY AND FITNESS FOR A PARTICULAR PURPOSE.**

Without limiting the generality of the foregoing, Qorvo products are not warranted or authorized for use as critical components in medical, life-saving, or life-sustaining applications, or other applications where a failure would reasonably be expected to cause severe personal injury or death.

Copyright 2017 © Qorvo, Inc. | Qorvo is a registered trademark of Qorvo, Inc.

Компания «Life Electronics» занимается поставками электронных компонентов импортного и отечественного производства от производителей и со складов крупных дистрибьюторов Европы, Америки и Азии.

С конца 2013 года компания активно расширяет линейку поставок компонентов по направлению коаксиальный кабель, кварцевые генераторы и конденсаторы (керамические, пленочные, электролитические), за счёт заключения дистрибьюторских договоров

Мы предлагаем:

- Конкурентоспособные цены и скидки постоянным клиентам.
- Специальные условия для постоянных клиентов.
- Подбор аналогов.
- Поставку компонентов в любых объемах, удовлетворяющих вашим потребностям.
- Приемлемые сроки поставки, возможна ускоренная поставка.
- Доставку товара в любую точку России и стран СНГ.
- Комплексную поставку.
- Работу по проектам и поставку образцов.
- Формирование склада под заказчика.
- Сертификаты соответствия на поставляемую продукцию (по желанию клиента).
- Тестирование поставляемой продукции.
- Поставку компонентов, требующих военную и космическую приемку.
- Входной контроль качества.
- Наличие сертификата ISO.

В составе нашей компании организован Конструкторский отдел, призванный помогать разработчикам, и инженерам.

Конструкторский отдел помогает осуществить:

- Регистрацию проекта у производителя компонентов.
- Техническую поддержку проекта.
- Защиту от снятия компонента с производства.
- Оценку стоимости проекта по компонентам.
- Изготовление тестовой платы монтаж и пусконаладочные работы.



Тел: +7 (812) 336 43 04 (многоканальный)  
Email: org@lifeelectronics.ru