

MOS FET Relays

G3VM-61HR

**Low 40-mΩ ON Resistance.
Higher power, 2.3-A switching with a
60-V load voltage, SOP package.**

- Continuous load current of 2.3 A (connection C = 4.6 A).
- Dielectric strength of 1,500 Vrms between I/O.

RoHS compliant

⚠ Refer to "Common Precautions".

NEW

Application Examples

- Broadband systems
- Measurement devices
- Data loggers
- Industrial equipment

Note: The actual product is marked differently from the image shown here.

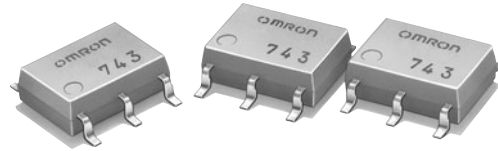

List of Models

Contact form	Terminals	Load voltage (peak value) (See note.)	Model	Number per stick	Number per tape
SPST-NO	Surface-mounting terminals	60 V	G3VM-61HR	75	---
			G3VM-61HR(TR)	---	2,500

Note: The AC peak and DC value is given for the load voltage.

Dimensions

Note: All units are in millimeters unless otherwise indicated.

G3VM-61HR

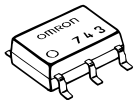

Note: The actual product is marked differently from the image shown here.

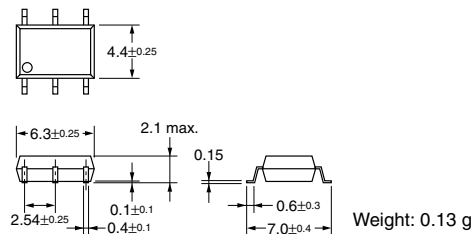

Terminal Arrangement/Internal Connections (Top View)

G3VM-61HR

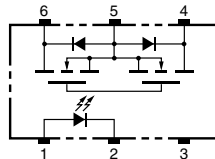

Actual Mounting Pad Dimensions (Recommended Value, Top View)

G3VM-61HR

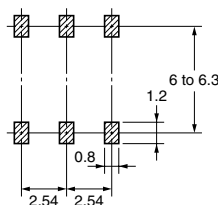

Absolute Maximum Ratings (Ta = 25°C)

Item		Symbol	Rating	Unit	Measurement Conditions	
Input	LED forward current	I_F	30	mA		
	LED forward current reduction rate	$\Delta I_F/^\circ\text{C}$	-0.3	mA/°C	Ta ≥ 25°C	
	LED reverse voltage	V_R	5	V		
	Connection temperature	T_j	125	°C		
Output	Load voltage (AC peak/DC)	V_{OFF}	60	V		
	Continuous load current	Connection A	I_O	2.3	A	Connection A: AC peak/DC Connection B and C: DC
		Connection B		2.3		
		Connection C		4.6		
	ON current reduction rate	Connection A	$\Delta I_O/^\circ\text{C}$	-30.7	mA/°C	Ta ≥ 50°C
		Connection B		-30.7		
Connection C			-61.3			
Pulse on current	I_{op}	7	A		t = 100 ms	
Connection temperature	T_j	125	°C			
Dielectric strength between input and output (See note 1.)		V_{I-O}	1,500	Vrms	AC for 1 min	
Operating temperature		T_a	-40 to +85	°C	With no icing or condensation	
Storage temperature		T_{stg}	-55 to +125	°C	With no icing or condensation	
Soldering temperature (10 s)		---	260	°C	10 s	

Note: 1. The dielectric strength between the input and output was checked by applying voltage between all pins as a group on the LED side and all pins as a group on the light-receiving side.

Connection Diagram

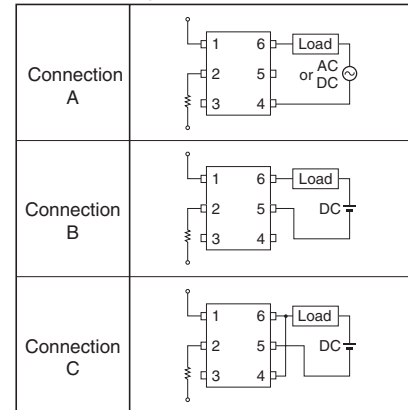

Electrical Characteristics (Ta = 25°C)

Item		Symbol	Minimum	Typical	Maximum	Unit	Measurement conditions	
Input	LED forward voltage	V_F	1.18	1.33	1.48	V	$I_F = 10 \text{ mA}$	
	Reverse current	I_R	---	---	10	μA	$V_R = 5 \text{ V}$	
	Capacity between terminals	C_T	---	70	---	pF	V = 0, f = 1 MHz	
	Trigger LED forward current	I_{FT}	---	0.4	3	mA	$I_O = 100 \text{ mA}$	
Output	Maximum resistance with output ON	Connection A	R_{ON}	---	0.04	0.07	Ω	$I_F = 5 \text{ mA}, I_O = 2 \text{ A}, t < 1 \text{ s}$
		Connection B		---	0.02	0.04	Ω	$I_F = 5 \text{ mA}, I_O = 2 \text{ A}, t < 1 \text{ s}$
		Connection C		---	0.01	---	Ω	$I_F = 5 \text{ mA}, I_O = 4 \text{ A}, t < 1 \text{ s}$
	Current leakage when the relay is open	I_{LEAK}	---	---	10	nA	$V_{OFF} = 60 \text{ V}$	
Capacity between I/O terminals		C_{I-O}	---	0.8	---	pF	f = 1 MHz, $V_s = 0 \text{ V}$	
Insulation resistance		R_{I-O}	1,000	---	---	MΩ	$V_{I-O} = 500 \text{ VDC}, \text{RoH} \leq 60\%$	
Turn-ON time		t_{ON}	---	1.0	5.0	ms	$I_F = 5 \text{ mA}, R_L = 200 \text{ } \Omega, V_{DD} = 20 \text{ V}$ (See note 2.)	
Turn-OFF time		t_{OFF}	---	0.15	1.0	ms		

Note: 2. Turn-ON and Turn-OFF Times

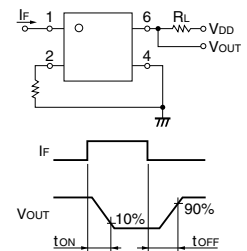

Recommended Operating Conditions

Use the G3VM under the following conditions so that the Relay will operate properly.

Item	Symbol	Minimum	Typical	Maximum	Unit
Load voltage (AC peak/DC)	V_{DD}	---	---	60	V
Operating LED forward current	I_F	5	7.5	20	mA
Continuous load current (AC peak/DC)	I_O	---	---	1.8	A
Operating temperature	T_a	-20	---	65	°C

Engineering Data

Load Current vs. Ambient Temperature G3VM-61HR

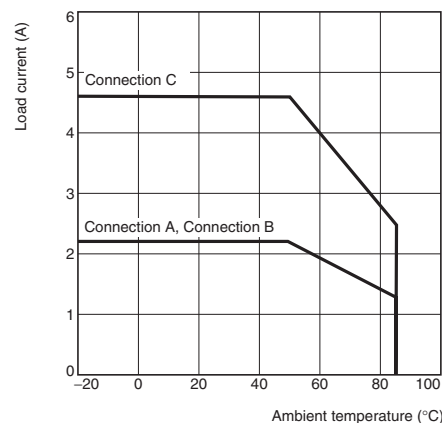

Safety Precautions

Refer to "Common Precautions" for all G3VM models.

Компания «Life Electronics» занимается поставками электронных компонентов импортного и отечественного производства от производителей и со складов крупных дистрибьюторов Европы, Америки и Азии.

С конца 2013 года компания активно расширяет линейку поставок компонентов по направлению коаксиальный кабель, кварцевые генераторы и конденсаторы (керамические, пленочные, электролитические), за счёт заключения дистрибьюторских договоров

Мы предлагаем:

- Конкуренспособные цены и скидки постоянным клиентам.
- Специальные условия для постоянных клиентов.
- Подбор аналогов.
- Поставку компонентов в любых объемах, удовлетворяющих вашим потребностям.
- Приемлемые сроки поставки, возможна ускоренная поставка.
- Доставку товара в любую точку России и стран СНГ.
- Комплексную поставку.
- Работу по проектам и поставку образцов.
- Формирование склада под заказчика.
- Сертификаты соответствия на поставляемую продукцию (по желанию клиента).
- Тестирование поставляемой продукции.
- Поставку компонентов, требующих военную и космическую приемку.
- Входной контроль качества.
- Наличие сертификата ISO.

В составе нашей компании организован Конструкторский отдел, призванный помогать разработчикам, и инженерам.

Конструкторский отдел помогает осуществить:

- Регистрацию проекта у производителя компонентов.
- Техническую поддержку проекта.
- Защиту от снятия компонента с производства.
- Оценку стоимости проекта по компонентам.
- Изготовление тестовой платы монтаж и пусконаладочные работы.



Тел: +7 (812) 336 43 04 (многоканальный)

Email: org@lifeelectronics.ru