

## Description

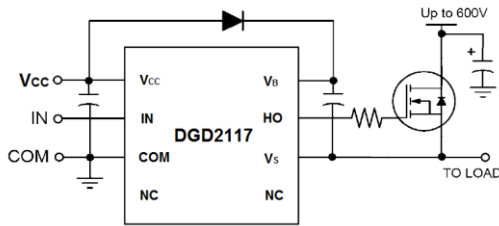
The DGD2117 and DGD2118 are high voltage / high speed gate drivers capable of driving one N-Channel MOSFET or IGBT in a bootstrap configuration. High voltage processing techniques enable the DGD2117 and DGD2118 to switch at 600V.

The DGD2117 and DGD2118 logic inputs are compatible with standard CMOS outputs. The driver outputs feature high pulse current buffers designed for minimum driver cross conduction. The single floating channel can be used in high side and low side configuration.

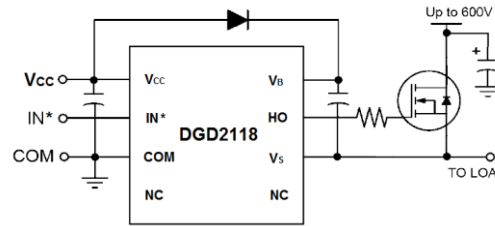
The DGD2117 and DGD2118 are offered in SO-8 (Type TH) package and the operating temperature extends from -40°C to +125°C.

## Applications

- DC-DC Converters
- DC-AC Inverters
- AC-DC Power Supplies
- Motor Controls
- Class D Power Amplifiers



Typical Configuration



SO-8 (Type TH)  
Top View

## Features

- Floating Channel in Bootstrap Operation to 600V
- Drives One N-Channel MOSFET or IGBT
- Outputs Tolerant to Negative Transients
- Wide Logic Supply: 10V to 20V
- Schmitt Triggered Logic Input with Internal Pull Down
- Undervoltage Lockout
- Extended Temperature Range: -40°C to +125°C
- **Totally Lead-Free & Fully RoHS Compliant (Notes 1 & 2)**
- **Halogen and Antimony Free. "Green" Device (Note 3)**

## Mechanical Data

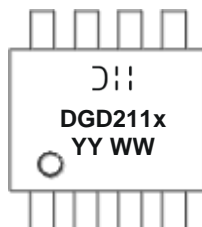
- Case: SO-8 (Type TH)
- Case Material: Molded Plastic. "Green" Molding Compound.
- UL Flammability Classification Rating 94V-0
- Moisture Sensitivity: Level 3 per J-STD-020
- Terminals: Finish – Matte Tin Plated Leads. Solderable per MIL-STD-202, Method 208 (E3)
- Weight: 0.075 grams (Approximate)

## Ordering Information (Note 4)

Part number	Marking	Reel size (inches)	Tape width (mm)	Quantity per reel
DGD2117S8-13	DGD2117	13	12	2,500
DGD2118S8-13	DGD2118	13	12	2,500

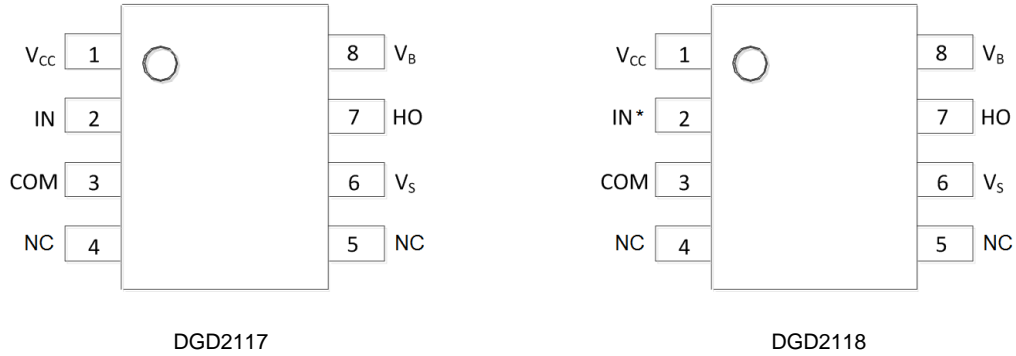
- Notes:
1. No purposely added lead. Fully EU Directive 2002/95/EC (RoHS) & 2011/65/EU (RoHS 2) compliant.
  2. See [http://www.diodes.com/quality/lead\\_free.html](http://www.diodes.com/quality/lead_free.html) for more information about Diodes Incorporated's definitions of Halogen- and Antimony-free, "Green" and Lead-free.
  3. Halogen- and Antimony-free "Green" products are defined as those which contain <900ppm bromine, <900ppm chlorine (<1500ppm total Br + Cl) and <1000ppm antimony compounds.
  4. For packaging details, go to our website at <http://www.diodes.com/products/packages.html>.

## Marking Information



- D = Manufacturer's Marking
- DGD211x = Product Type Marking Code (See Table Above)
- YY = Year (ex: 16 = 2016)
- WW = Week (01 to 53)

**Pin Diagrams**

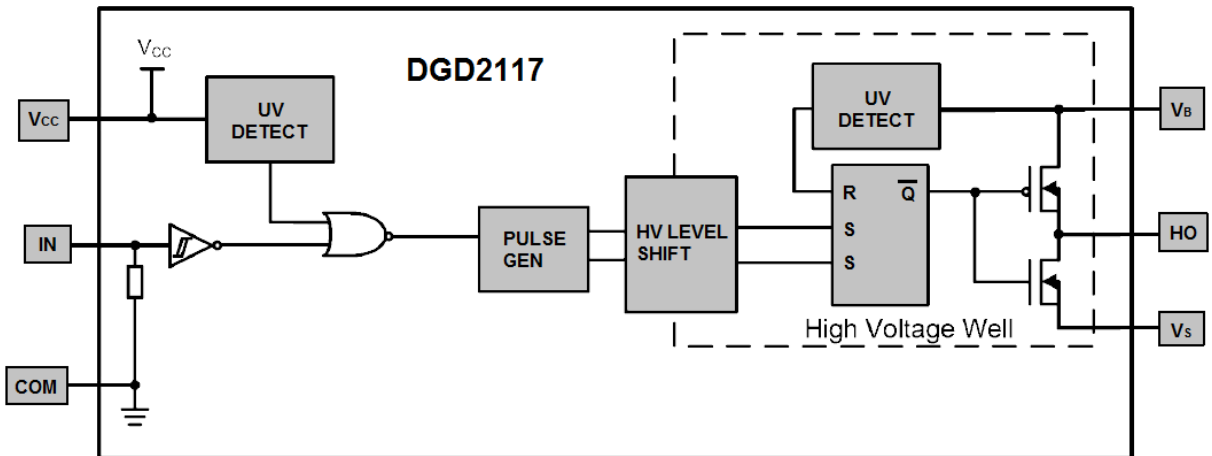


Top View SO-8 (Type TH)

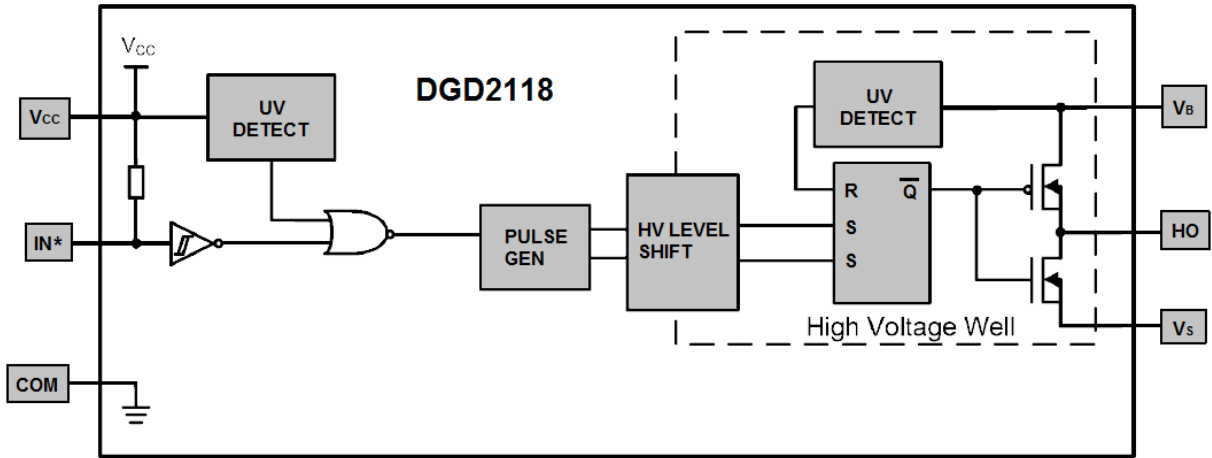
**Pin Descriptions**

Pin Number	Pin Name	Function
1	V <sub>CC</sub>	Logic and gate driver supply
2	IN	DGD2117 Logic input for gate driver output (HO), in phase with HO
2	IN*	DGD2118 Logic input for gate driver output (HO), out of phase with HO
3	COM	Logic ground
4, 5	NC	No Connection (No Internal Connection)
6	V <sub>S</sub>	High-side floating supply return
7	HO	High-side gate drive output
8	V <sub>B</sub>	High-side floating supply

**Functional Block Diagram**



**Functional Block Diagram (Cont.)**



**Absolute Maximum Ratings** (@T<sub>A</sub> = +25°C, unless otherwise specified.)

Characteristic	Symbol	Value	Unit
High-side Floating Supply Voltage	V <sub>B</sub>	-0.3 to +624	V
High-side Floating Supply Offset Voltage	V <sub>S</sub>	V <sub>B</sub> -24 to V <sub>B</sub> +0.3	V
High-side Floating Output Voltage	V <sub>HO</sub>	V <sub>S</sub> -0.3 to V <sub>B</sub> +0.3	V
Logic Supply Voltage	V <sub>CC</sub>	-0.3 to +24	V
Logic Input Voltage	V <sub>IN</sub>	-0.3 to V <sub>CC</sub> +0.3	V
Allowable Offset Supply Voltage Transient	dV <sub>S</sub> / dt	50	V/ns

**Thermal Characteristics** (@T<sub>A</sub> = +25°C, unless otherwise specified.)

Characteristic	Symbol	Value	Unit
Power Dissipation Linear Derating Factor (Note 5)	P <sub>D</sub>	0.625	W
Thermal Resistance, Junction to Ambient (Note 5)	R <sub>θJA</sub>	200	°C/W
Thermal Resistance, Junction to Case (Note 6)	R <sub>θJC</sub>	45	°C/W
Operating Temperature	T <sub>J</sub>	+150	°C
Lead Temperature (Soldering, 10s)	T <sub>L</sub>	+300	
Storage Temperature Range	T <sub>STG</sub>	-55 to +150	

Note: 5. When mounted on a standard JEDEC 2-layer FR-4 board.

**Recommended Operating Conditions**

Parameter	Symbol	Min	Max	Unit
High Side Floating Supply Absolute Voltage	V <sub>B</sub>	V <sub>S</sub> + 10	V <sub>S</sub> + 20	V
High Side Floating Supply Offset Voltage	V <sub>S</sub>	(Note 6)	600	V
High Side Floating Output Voltage	V <sub>HO</sub>	V <sub>S</sub>	V <sub>B</sub>	V
Low Side and Logic Fixed Supply Voltage	V <sub>CC</sub>	10	20	V
Logic Input Voltage	V <sub>IN</sub>	0	V <sub>CC</sub>	V
Ambient Temperature	T <sub>A</sub>	-40	+125	°C

Note: 6. Logic operation for V<sub>S</sub> = -5V to +600V. Logic state held for V<sub>S</sub> of -5V to -V<sub>BS</sub>.

**DC Electrical Characteristics** ( $V_{BIAS}$  ( $V_{CC}$ ,  $V_{BS}$ ) = 15V, @ $T_A$  = +25°C, unless otherwise specified.) (Note 7)

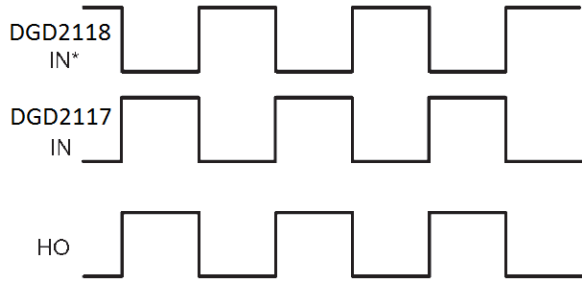
Parameter	Symbol	Min	Typ	Max	Unit	Conditions	
Logic "1" (DGD2117) & Logic "0" (DGD2118) Input Voltage	$V_{IH}$	9.5	–	–	V	–	
Logic "0" (DGD2117) & Logic "1" (DGD2118) Input Voltage	$V_{IL}$	–	–	6.0	V	–	
High Level Output Voltage, $V_{BIAS} - V_O$	$V_{OH}$	–	0.05	0.2	V	$I_O = 2\text{mA}$	
Low Level Output Voltage, $V_O$	$V_{OL}$	–	0.02	0.1	V	$I_O = 2\text{mA}$	
Offset Supply Leakage Current	$I_{LK}$	–	–	50	$\mu\text{A}$	$V_B = V_S = 600\text{V}$	
Quiescent $V_{BS}$ Supply Current	$I_{BSQ}$	–	50	240	$\mu\text{A}$	$V_{IN} = 0\text{V}$ or $V_{CC}$	
Quiescent $V_{CC}$ Supply Current	$I_{CCQ}$	–	70	340	$\mu\text{A}$	$V_{IN} = 0\text{V}$ or $V_{CC}$	
Logic "1" Input Bias Current	DGD2117	$I_{IN+}$	–	20	40	$\mu\text{A}$	$V_{IN} = V_{CC}$
	DGD2118						$V_{IN} = 0\text{V}$
Logic "0" Input Bias Current	DGD2117	$I_{IN-}$	–	–	5.0	$\mu\text{A}$	$V_{IN} = 0\text{V}$
	DGD2118						$V_{IN} = V_{CC}$
$V_{BS}$ Supply Under-voltage Positive Going Threshold	$V_{BSUV+}$	7.6	8.6	9.6	V	–	
$V_{BS}$ Supply Under-voltage Negative Going Threshold	$V_{BSUV-}$	7.2	8.2	9.2	V	–	
$V_{CC}$ Supply Under-voltage Positive Going Threshold	$V_{CCUV+}$	7.6	8.6	9.6	V	–	
$V_{CC}$ Supply Under-voltage Negative Going Threshold	$V_{CCUV-}$	7.2	8.2	9.2	V	–	
Output High Short Circuit Pulsed Current	$I_{O+}$	200	290	–	mA	$V_O = 0\text{V}$ , $V_{IN} = \text{Logic "1"}$ , $PW \leq 10\mu\text{s}$	
Output Low Short Circuit Pulsed Current	$I_{O-}$	420	600	–	mA	$V_O = 15\text{V}$ , $V_{IN} = \text{Logic "0"}$ , $PW \leq 10\mu\text{s}$	

Note: 7. The  $V_{IN}$  and  $I_{IN}$  parameters are referenced to COM and are applicable to the logic input pins: IN and IN\*. The  $V_O$  and  $I_O$  parameters are referenced to COM and are applicable to the output pin: HO.

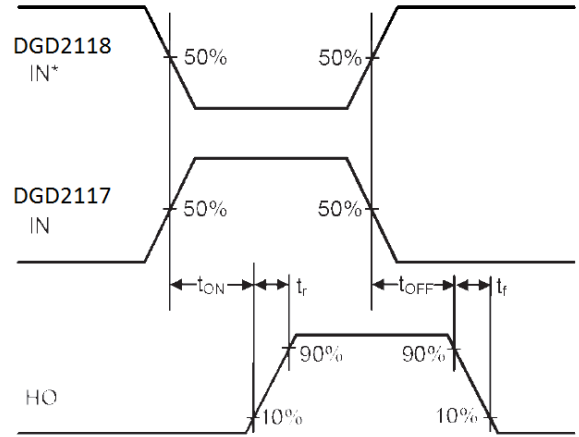
**AC Electrical Characteristics** ( $V_{BIAS}$  ( $V_{CC}$ ,  $V_{BS}$ ) = 15V,  $C_L = 1000\text{pF}$ , @ $T_A$  = +25°C, unless otherwise specified.)

Parameter	Symbol	Min	Typ	Max	Unit	Conditions
Turn-on Propagation Delay	$t_{ON}$	–	125	200	ns	$V_S = 0\text{V}$
Turn-off Propagation Delay	$t_{OFF}$	–	105	180	ns	$V_S = 600\text{V}$
Turn-on Rise Time	$t_r$	–	75	130	ns	–
Turn-off Fall Time	$t_f$	–	35	65	ns	–

**Timing Waveforms**

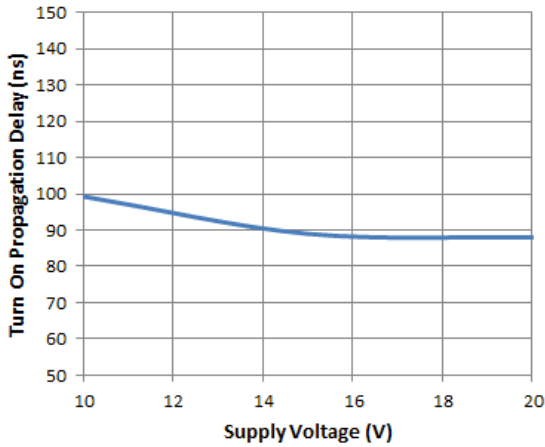


**Figure 1.** Input / Output Timing Diagram

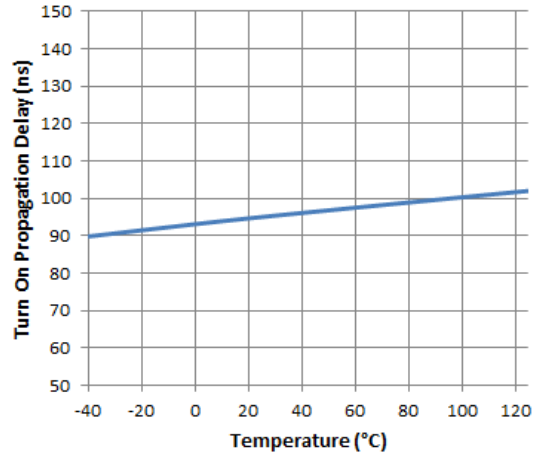


**Figure 2.** Switching Time Waveform Definitions

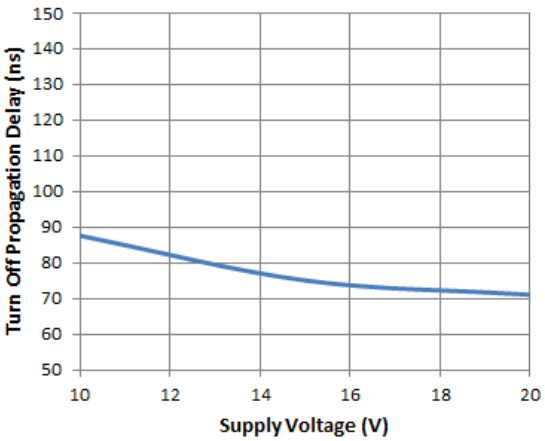
**Typical Performance Characteristics** (@T<sub>A</sub> = +25°C, unless otherwise specified.)



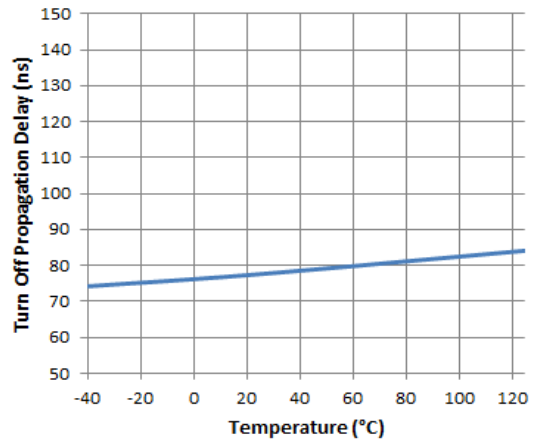
**Figure 3.** Turn-on Propagation Delay vs. Supply Voltage



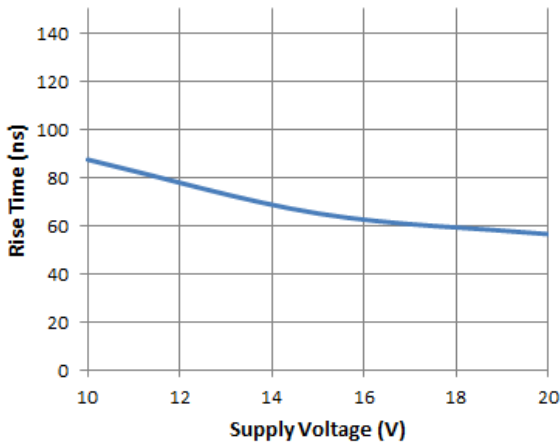
**Figure 4.** Turn-on Propagation Delay vs. Temperature



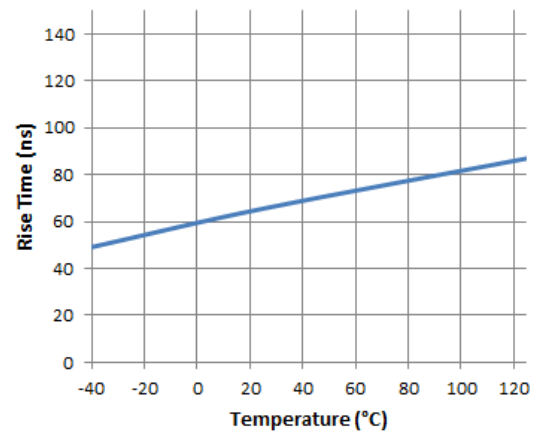
**Figure 5.** Turn-off Propagation Delay vs. Supply Voltage



**Figure 6.** Turn-off Propagation Delay vs. Temperature

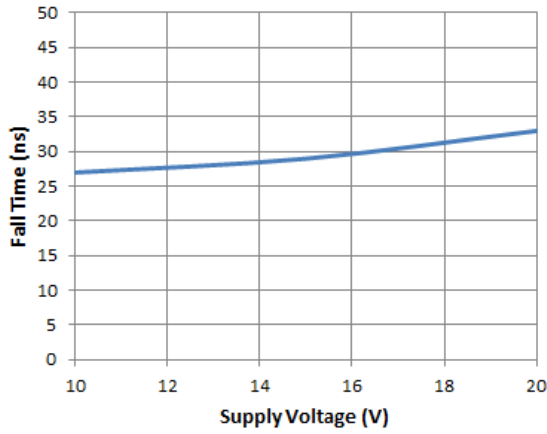


**Figure 7.** Rise Time vs. Supply Voltage

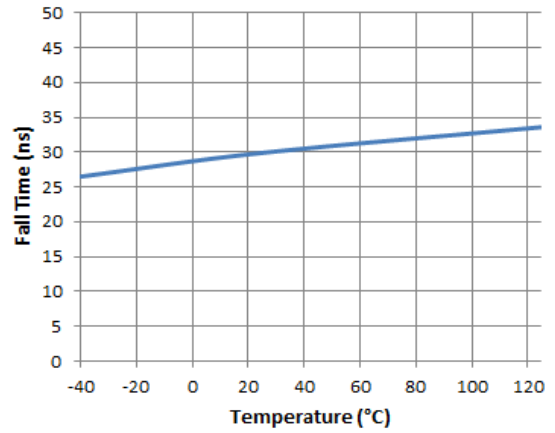


**Figure 8.** Rise Time vs. Temperature

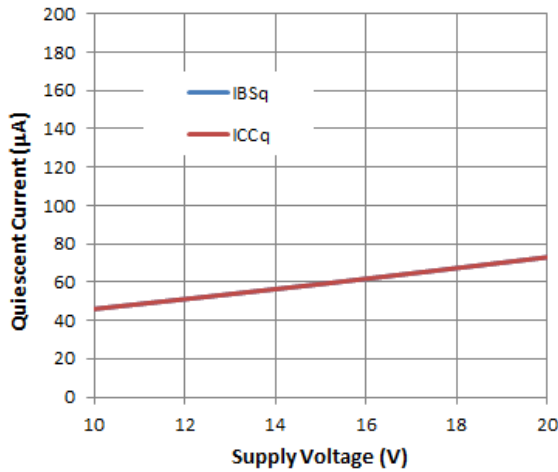
**Typical Performance Characteristics (Cont.)**



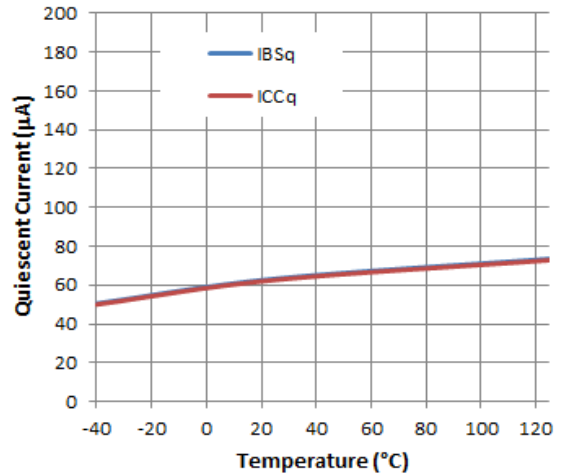
**Figure 9.** Fall Time vs. Supply Voltage



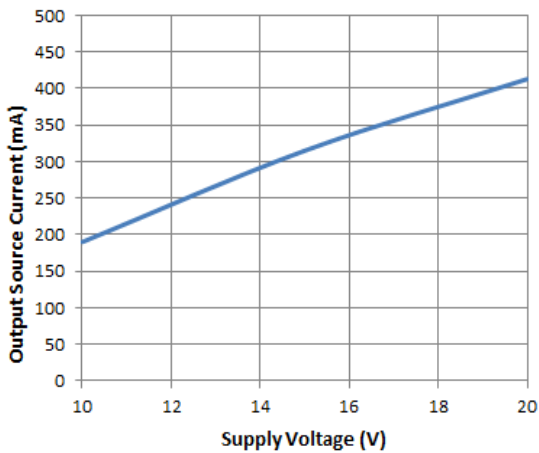
**Figure 10.** Fall Time vs. Temperature



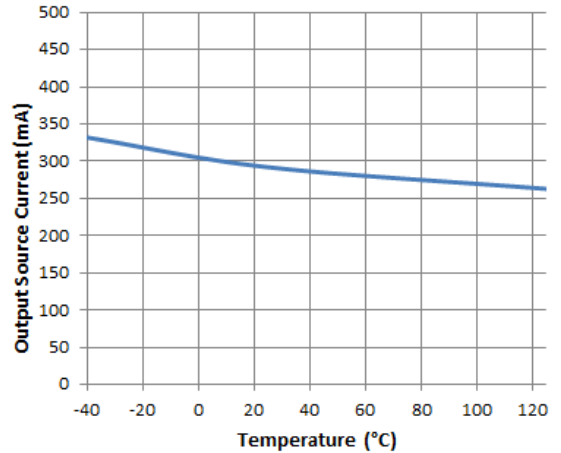
**Figure 11.** Quiescent Current vs. Supply Voltage



**Figure 12.** Quiescent Current vs. Temperature

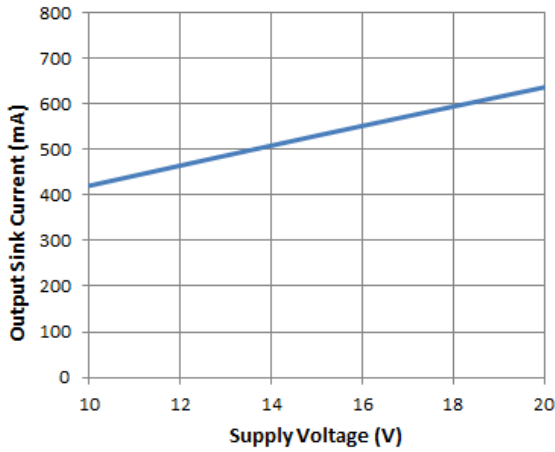


**Figure 13.** Output Source Current vs. Supply Voltage

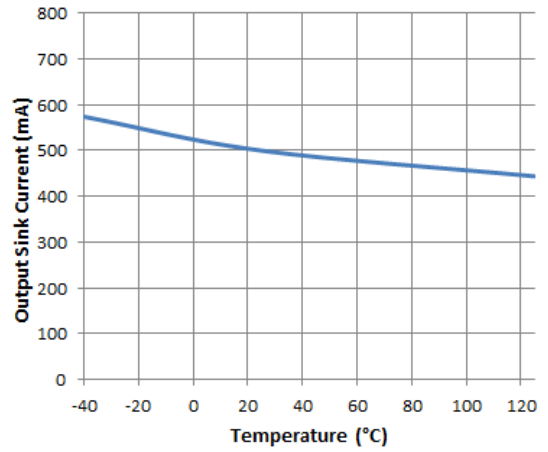


**Figure 14.** Output Source Current vs. Temperature

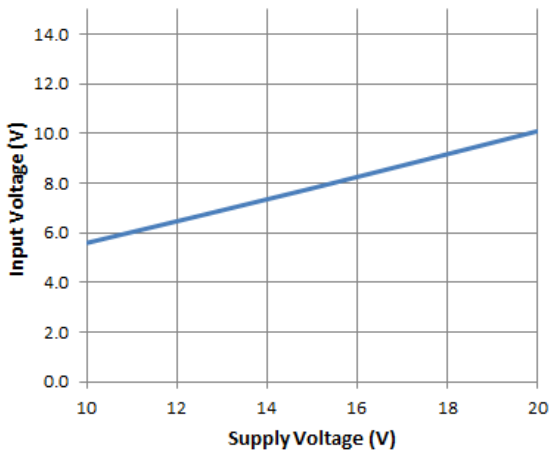
**Typical Performance Characteristics (Cont.)**



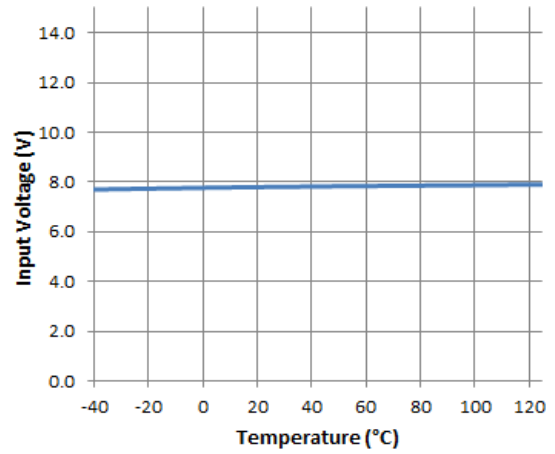
**Figure 15.** Output Sink Current vs. Supply Voltage



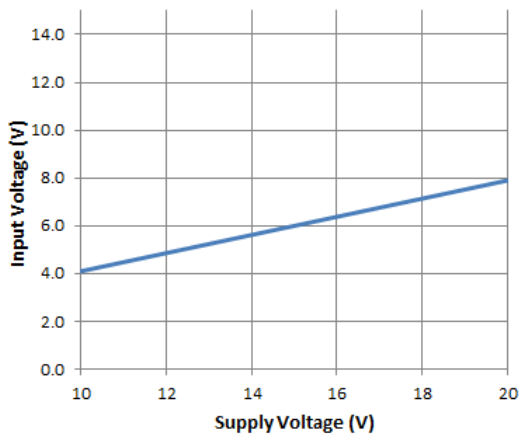
**Figure 16.** Output Sink Current vs. Temperature



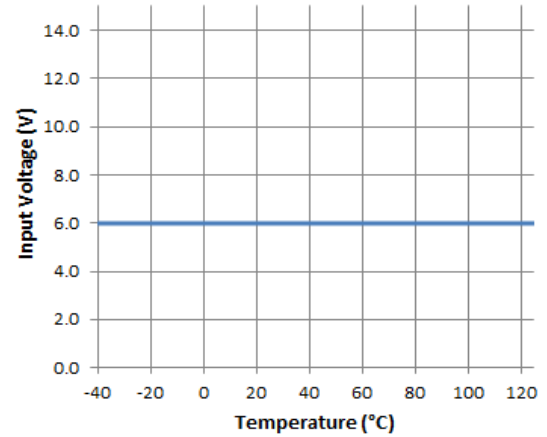
**Figure 17.** DGD2117 Logic 1 (DGD2118 Logic 0) Input Voltage vs. Supply Voltage



**Figure 18.** DGD2117 Logic 1 (DGD2118 Logic 0) Input Voltage vs. Temperature



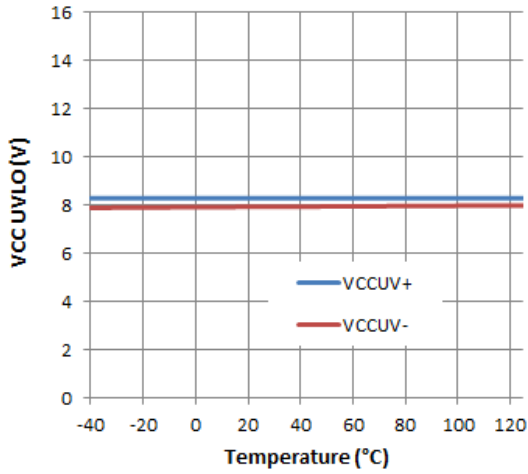
**Figure 19.** DGD2117 Logic 0 (DGD2118 Logic 1) Input Voltage vs. Supply Voltage



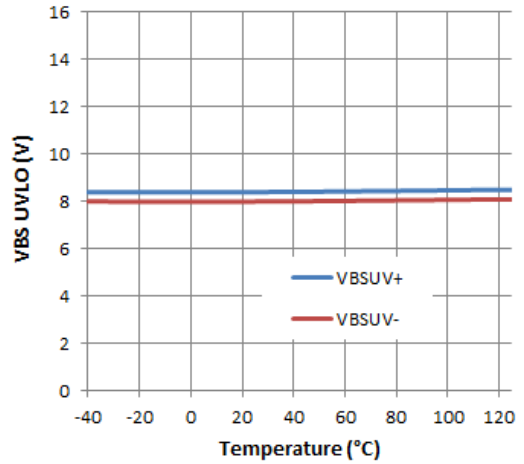
**Figure 20.** DGD2117 Logic 0 (DGD2118 Logic 1) Input Voltage vs. Temperature



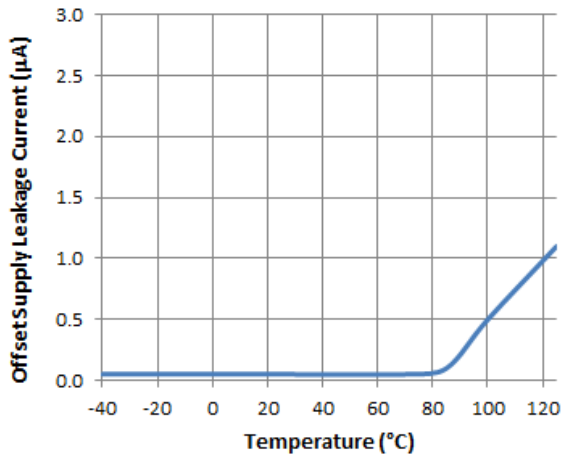
**Typical Performance Characteristics (Cont.)**



**Figure 21.** VCC UVLO vs. Temperature



**Figure 22.** VBS UVLO vs. Temperature

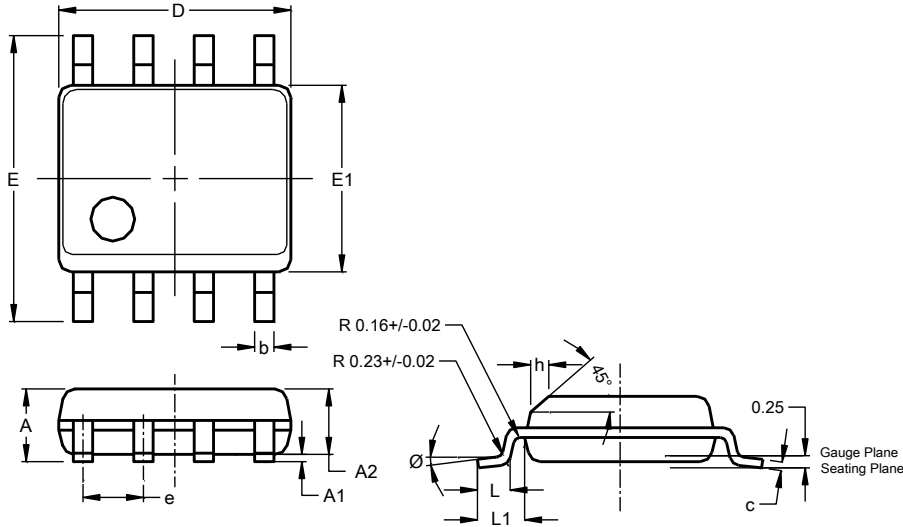


**Figure 23.** Offset Supply Leakage Current vs. Temperature

**Package Outline Dimensions**

Please see <http://www.diodes.com/package-outlines.html> for the latest version.

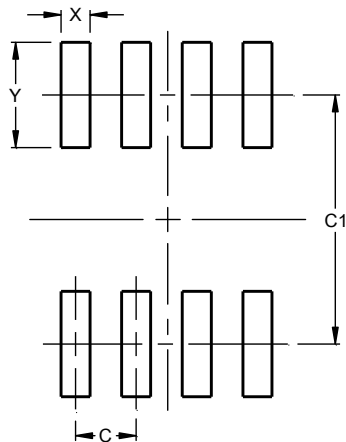
**SO-8 (Type TH)**



**Suggested Pad Layout**

Please see <http://www.diodes.com/package-outlines.html> for the latest version.

**SO-8 (Type TH)**



Dimensions	Value (in mm)
C	1.27
C1	5.20
X	0.60
Y	2.20

Note: For high voltage applications, the appropriate industry sector guidelines should be considered with regards to creepage and clearance distances between device Terminals and PCB tracking.

**IMPORTANT NOTICE**

DIODES INCORPORATED MAKES NO WARRANTY OF ANY KIND, EXPRESS OR IMPLIED, WITH REGARDS TO THIS DOCUMENT, INCLUDING, BUT NOT LIMITED TO, THE IMPLIED WARRANTIES OF MERCHANTABILITY AND FITNESS FOR A PARTICULAR PURPOSE (AND THEIR EQUIVALENTS UNDER THE LAWS OF ANY JURISDICTION).

Diodes Incorporated and its subsidiaries reserve the right to make modifications, enhancements, improvements, corrections or other changes without further notice to this document and any product described herein. Diodes Incorporated does not assume any liability arising out of the application or use of this document or any product described herein; neither does Diodes Incorporated convey any license under its patent or trademark rights, nor the rights of others. Any Customer or user of this document or products described herein in such applications shall assume all risks of such use and will agree to hold Diodes Incorporated and all the companies whose products are represented on Diodes Incorporated website, harmless against all damages.

Diodes Incorporated does not warrant or accept any liability whatsoever in respect of any products purchased through unauthorized sales channel. Should Customers purchase or use Diodes Incorporated products for any unintended or unauthorized application, Customers shall indemnify and hold Diodes Incorporated and its representatives harmless against all claims, damages, expenses, and attorney fees arising out of, directly or indirectly, any claim of personal injury or death associated with such unintended or unauthorized application.

Products described herein may be covered by one or more United States, international or foreign patents pending. Product names and markings noted herein may also be covered by one or more United States, international or foreign trademarks.

This document is written in English but may be translated into multiple languages for reference. Only the English version of this document is the final and determinative format released by Diodes Incorporated.

**LIFE SUPPORT**

Diodes Incorporated products are specifically not authorized for use as critical components in life support devices or systems without the express written approval of the Chief Executive Officer of Diodes Incorporated. As used herein:

A. Life support devices or systems are devices or systems which:

1. are intended to implant into the body, or
2. support or sustain life and whose failure to perform when properly used in accordance with instructions for use provided in the labeling can be reasonably expected to result in significant injury to the user.

B. A critical component is any component in a life support device or system whose failure to perform can be reasonably expected to cause the failure of the life support device or to affect its safety or effectiveness.

Customers represent that they have all necessary expertise in the safety and regulatory ramifications of their life support devices or systems, and acknowledge and agree that they are solely responsible for all legal, regulatory and safety-related requirements concerning their products and any use of Diodes Incorporated products in such safety-critical, life support devices or systems, notwithstanding any devices- or systems-related information or support that may be provided by Diodes Incorporated. Further, Customers must fully indemnify Diodes Incorporated and its representatives against any damages arising out of the use of Diodes Incorporated products in such safety-critical, life support devices or systems.

Copyright © 2016, Diodes Incorporated

**[www.diodes.com](http://www.diodes.com)**

Компания «Life Electronics» занимается поставками электронных компонентов импортного и отечественного производства от производителей и со складов крупных дистрибьюторов Европы, Америки и Азии.

С конца 2013 года компания активно расширяет линейку поставок компонентов по направлению коаксиальный кабель, кварцевые генераторы и конденсаторы (керамические, пленочные, электролитические), за счёт заключения дистрибьюторских договоров

Мы предлагаем:

- Конкурентоспособные цены и скидки постоянным клиентам.
- Специальные условия для постоянных клиентов.
- Подбор аналогов.
- Поставку компонентов в любых объемах, удовлетворяющих вашим потребностям.
- Приемлемые сроки поставки, возможна ускоренная поставка.
- Доставку товара в любую точку России и стран СНГ.
- Комплексную поставку.
- Работу по проектам и поставку образцов.
- Формирование склада под заказчика.
- Сертификаты соответствия на поставляемую продукцию (по желанию клиента).
- Тестирование поставляемой продукции.
- Поставку компонентов, требующих военную и космическую приемку.
- Входной контроль качества.
- Наличие сертификата ISO.

В составе нашей компании организован Конструкторский отдел, призванный помогать разработчикам, и инженерам.

Конструкторский отдел помогает осуществить:

- Регистрацию проекта у производителя компонентов.
- Техническую поддержку проекта.
- Защиту от снятия компонента с производства.
- Оценку стоимости проекта по компонентам.
- Изготовление тестовой платы монтаж и пусконаладочные работы.



Тел: +7 (812) 336 43 04 (многоканальный)

Email: [org@lifeelectronics.ru](mailto:org@lifeelectronics.ru)