



# Praetorian III® 4, 6, 8-Channel EMI Filter Array with ESD Protection

## CM1457

### Features

- Four, six, or eight channels of EMI filtering
- $\pm 15\text{kV}$  ESD protection (IEC 61000-4-2, contact discharge) at external pins
- Greater than -40dB of attenuation at 1GHz MIL\_STD\_883 international ESD standard
- Chip Scale Package (CSP) with 0.40mm pitch and 0.25mm CSP solder ball which features extremely low parasitic inductance for optimum filter and ESD performance
- *OptiGuard*™ coating for improved reliability at assembly
- RoHS-compliant, lead-free finishing

### Applications

- LCD and camera data lines in mobile handsets
- I/O port protection for mobile handsets, notebook computers, PDAs, etc.
- EMI filtering for data ports in cell phones, PDAs or notebook computer
- Wireless handsets
- Handheld PCs/PDAs
- LCD and camera modules

Note: Refer to Application Note AP-217, "The Chip Scale Package", for a detailed description of Chip Scale Packages offered by California Micro Devices. See <http://www.wlcsforum.org/documents/pdf/ap-217.pdf> for download.

### Functional Description

The CM1457 is an inductor-based (L-C) EMI filter array with ESD protection, which integrates four, six, or eight filters in a CSP form factor with 0.40mm pitch. Each EMI filter channel of the CM1457 is implemented with the component value of 6pF-35nH-4.7pF-35nH-1.8pF. The cut-off frequency at -3dB attenuation is 300MHz and can be used in applications where the data rates are as high as 160Mbps, while providing greater than -35dB attenuation over the 800MHz to 2.7GHz frequency range. The parts include ESD diodes on every I/O pin and provide a high level of protection against electrostatic discharge (ESD). The ESD protection diodes connected to the external filter ports are designed and characterized to safely dissipate ESD strikes of  $\pm 15\text{kV}$ , which is beyond the maximum requirement of the IEC61000-4-2 international standard.

This device is particularly well suited for wireless handsets, mobile LCD modules and PDAs because of its small package format and easy-to-use pin assignments. In particular, the CM1457 is ideal for EMI filtering and protecting data and control lines for the LCD display and camera interface in mobile handsets.

The CM1457 incorporates OptiGuard™ which results in improved reliability at assembly. It is manufactured with a 0.40mm pitch and 0.25mm CSP solder ball to provide up to 28% board space savings vs. competing CSP devices with 0.50mm pitch and 0.30mm CSP solder ball.

### Block Diagram

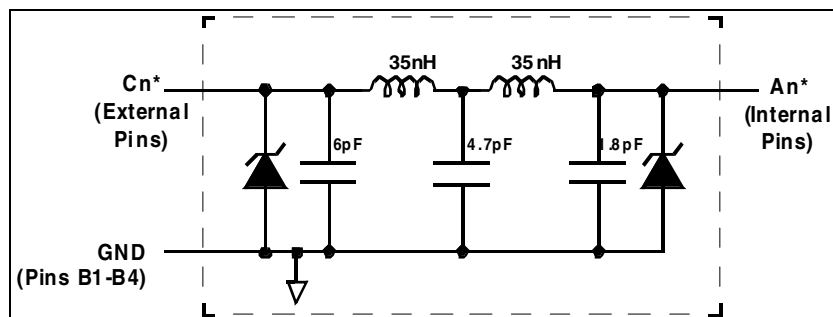

Pin Configurations

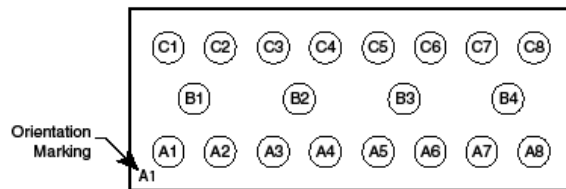
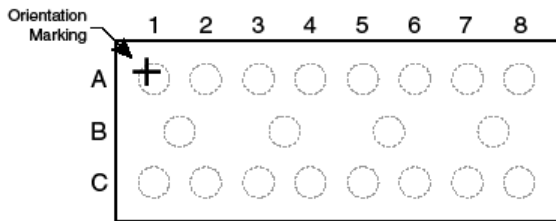
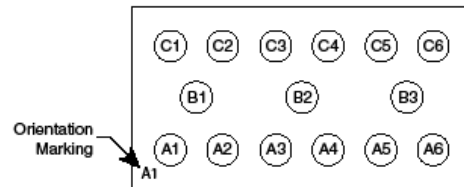
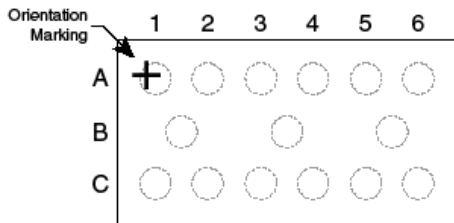
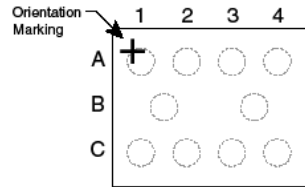

TO  
Bumps

# CM1457

## Pin Descriptions

PIN NUMBER			PIN DESCRIPTION	PIN NUMBER			PIN DESCRIPTION
-04	-06	-08		-04	-06	-08	
A1	A1	A1	Filter #1 (Internal)	C1	C1	C1	Filter #1 (External)
A2	A2	A2	Filter #2 (Internal)	C2	C2	C2	Filter #2 (External)
A3	A3	A3	Filter #3 (Internal)	C3	C3	C3	Filter #3 (External)
A4	A4	A4	Filter #4 (Internal)	C4	C4	C4	Filter #4 (External)
	A5	A5	Filter #5 (Internal)		C5	C5	Filter #5 (External)
	A6	A6	Filter #6 (Internal)		C6	C6	Filter #6 (External)
		A7	Filter #7 (Internal)			C7	Filter #7 (External)
		A8	Filter #8 (Internal)			C8	Filter #8 (External)
B1	B1	B1	GND				
B2	B2	B2	GND				
	B3	B3	GND				
		B4	GND				

## Ordering Information

Bumps	Package	Ordering Part Number <sup>1</sup>	Part Marking <sup>2</sup>
10	CSP	CM1457-04CP	N57 (w)
15	CSP	CM1457-06CP	N57 (yww)
20	CSP	CM1457-08CP	N57 (yyww)

Note 1: Parts are shipped in Tape and Reel form unless otherwise specified.

Note 2: (w/yww/yyww) = date code

## Absolute Maximum Ratings

PARAMETER	RATING	UNITS
Storage Temperature Range	-65 to +150	°C
DC current per Inductor	15	mA
DC Package Power Rating	0.5	W

## Standard Operating Conditions

PARAMETER	RATING	UNITS
Operating Temperature Range	-40 to +85	°C

## Electrical Operating Characteristics (see Note 1)

SYMBOL	PARAMETER	CONDITIONS	MIN	TYP	MAX	UNITS
$L_{TOT}$	Total Channel Inductance			70		nH
$R_{TOT}$	Total Channel DC Resistance			45		$\Omega$
$C_{TOT\_0V}$	Total Channel Capacitance, 0V bias	0V dc; 1MHz, 30mV rms		20	24	pF
$C_{TOT\_2.5V}$	Total Channel Capacitance, 2.5V bias	2.5V dc; 1MHz, 30mV rms		12.5		pF
$V_{ST}$	Stand-off Voltage	$I = 10\mu A$	5.5			V
$I_{LEAK}$	Diode Leakage Current	$V_{IN} = +3.3V$		0.1	0.5	$\mu A$
$V_{SIG}$	Signal Clamp Voltage Positive Clamp Negative Clamp	$I_{LOAD} = 10mA$ $I_{LOAD} = -10mA$	5.6 -1.5	6.8 -0.8	9.0 -0.4	V V
$V_{ESD}$	In-system ESD Withstand Voltage a) Contact discharge per IEC 61000-4-2 standard, Level 4 <b>(External Pins)</b> b) Contact discharge per IEC 61000-4-2 standard, Level 4 <b>(Internal Pins)</b>	Notes 2 and 3	$\pm 15$ $\pm 2$			kV kV
$f_c$	Cut-off frequency $Z_{SOURCE} = 50\Omega$ , $Z_{LOAD} = 50\Omega$			300		MHz

Note 1:  $T_A = 25^\circ C$  unless otherwise specified.

Note 2: ESD applied to input and output pins with respect to GND, one at a time.

Note 3: Unused pins are left open.

# CM1457

## Performance Information

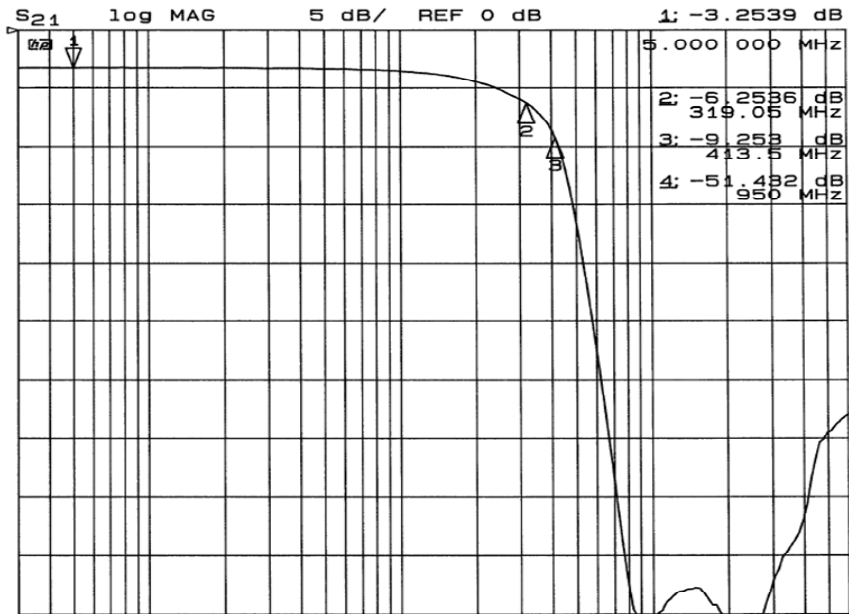

**0 dB**

Insertion Loss Vs. Frequency (0V Bias)

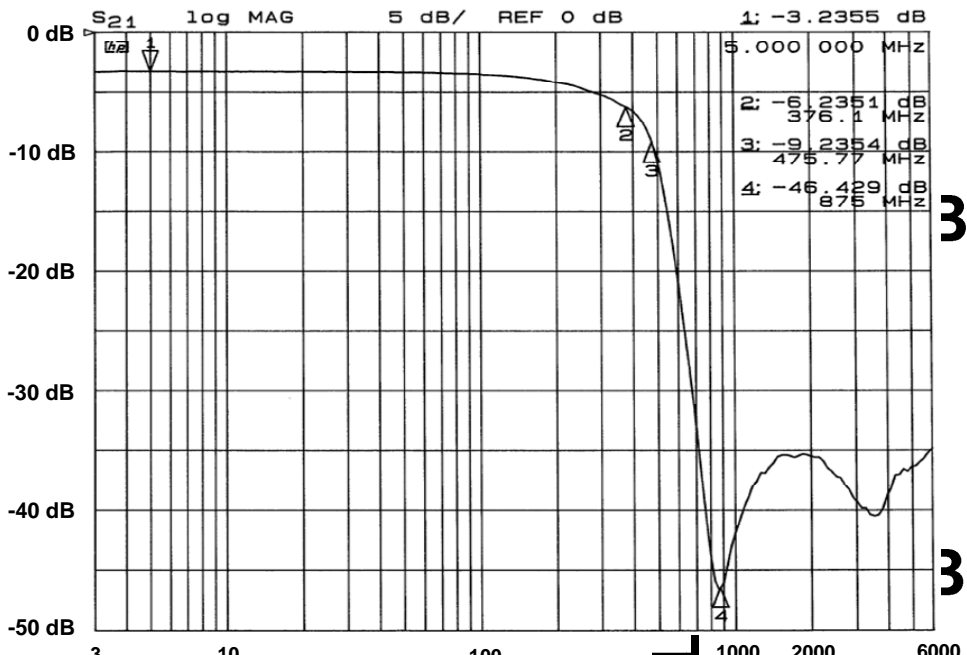

**3**

**3**

FREQUENCY (MHz)

Insertion Loss Vs. Frequency (2.5V Bias)

**INSERTION LOSS**

**-30 dB**

## CM1457-04CP Mechanical Specifications

The 10-bump CM1457-04CP package dimensions are shown below.

Package Specifications						
Package	Custom CSP					
Bumps	10					
Dim	Millimeters			Inches		
	Min	Nom	Max	Min	Nom	Max
A1	1.627	1.672	1.717	0.0641	0.0658	0.0676
A2	1.008	1.053	1.098	0.0397	0.0415	0.0432
B1	0.395	0.400	0.405	0.0156	0.0157	0.0159
B2	0.195	0.200	0.205	0.0077	0.0079	0.0081
B3	0.342	0.347	0.352	0.0135	0.0137	0.0139
B4	0.342	0.347	0.352	0.0135	0.0137	0.0139
C1	0.186	0.236	0.286	0.0073	0.0093	0.0113
C2	0.130	0.180	0.230	0.0051	0.0071	0.0090
D1	0.545	0.615	0.685	0.0215	0.0242	0.0270
D2	0.378	0.419	0.460	0.0149	0.0165	0.0181
<b>Controlling dimension: millimeters</b>						



**Package Dimensions for CM1457-04CP Chip Scale Package**

## CSP Tape and Reel Specifications

PART NUMBER	CHIP SIZE (mm)	POCKET SIZE (mm) $B_0 \times A_0 \times K_0$	TAPE WIDTH W	REEL DIAMETER	QTY PER REEL	$P_0$	$P_1$
CM1457-04CP	1.67 X 1.05 X 0.615	1.80 X 1.27 X 0.73	8mm	178mm (7")	3500	4mm	4mm



# CM1457

## CM1457-04CP Mechanical Specifications

The 15-bump CM1457-06CP package dimensions are shown below.

Package Specifications						
Package	Custom CSP					
Bumps	15					
Dim	Millimeters			Inches		
	Min	Nom	Max	Min	Nom	Max
A1	2.427	2.472	2.517	0.0956	0.0973	0.0992
A2	1.008	1.053	1.098	0.0397	0.0415	0.0432
B1	0.395	0.400	0.405	0.0156	0.0157	0.0159
B2	0.195	0.200	0.205	0.0077	0.0079	0.0081
B3	0.342	0.347	0.352	0.0135	0.0137	0.0139
B4	0.342	0.347	0.352	0.0135	0.0137	0.0139
C1	0.187	0.237	0.287	0.0074	0.0093	0.0113
C2	0.130	0.180	0.230	0.0051	0.0071	0.0090
D1	0.545	0.615	0.685	0.0215	0.0242	0.0270
D2	0.368	0.419	0.470	0.0145	0.0165	0.0185
# per tape and reel	3500 pieces					
Controlling dimension: millimeters						

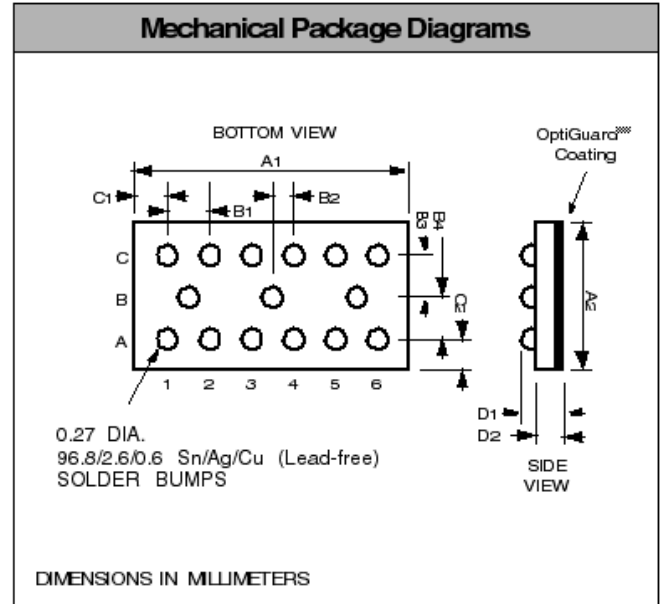

Package Dimensions for CM1457-06CP Chip Scale Package

## CSP Tape and Reel Specifications

PART NUMBER	CHIP SIZE (mm)	POCKET SIZE (mm) $B_0 \times A_0 \times K_0$	TAPE WIDTH W	REEL DIAMETER	QTY PER REEL	$P_0$	$P_1$
CM1457-06	2.47 X 1.05 X 0.615	2.59 X 1.27 X 0.73	8mm	178mm (7")	3500	4mm	4mm



## CM1457-08CP Mechanical Specifications

The 20-bump CM1457-08CP package dimensions are shown below.

Package Specifications						
Package	Custom CSP					
Bumps	20					
Dim	Millimeters			Inches		
	Min	Nom	Max	Min	Nom	Max
A1	3.227	3.272	3.317	0.1270	0.1288	0.1306
A2	1.008	1.053	1.098	0.0397	0.0415	0.0432
B1	0.395	0.400	0.405	0.0156	0.0157	0.0159
B2	0.195	0.200	0.205	0.0077	0.0079	0.0081
B3	0.342	0.347	0.352	0.0135	0.0137	0.0139
B4	0.342	0.347	0.352	0.0135	0.0137	0.0139
C1	0.186	0.236	0.286	0.0073	0.0093	0.0113
C2	0.130	0.180	0.230	0.0051	0.0071	0.0090
D1	0.545	0.615	0.685	0.0215	0.0242	0.0270
D2	0.368	0.419	0.470	0.0145	0.0165	0.0185
# per tape and reel	3500 pieces					
Controlling dimension: millimeters						



Package Dimensions for CM1457-08CP Chip Scale Package

## CSP Tape and Reel Specifications

PART NUMBER	CHIP SIZE (mm)	POCKET SIZE (mm) $B_0 \times A_0 \times K_0$	TAPE WIDTH W	REEL DIAMETER	QTY PER REEL	$P_0$	$P_1$
CM1457-08CP	3.27 X 1.05 X 0.615	3.40 X 1.27 X 0.73	12mm	330mm (13")	3500	4mm	4mm

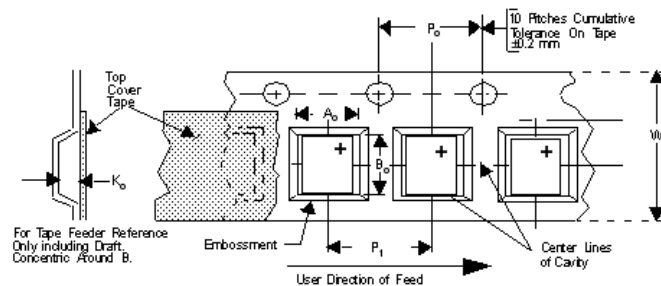



ON Semiconductor and  are registered trademarks of Semiconductor Components Industries, LLC (SCILLC). SCILLC reserves the right to make changes without further notice to any products herein. SCILLC makes no warranty, representation or guarantee regarding the suitability of its products for any particular purpose, nor does SCILLC assume any liability arising out of the application or use of any product or circuit, and specifically disclaims any and all liability, including without limitation special, consequential or incidental damages. "Typical" parameters which may be provided in SCILLC data sheets and/or specifications can and do vary in different applications and actual performance may vary over time. All operating parameters, including "Typicals" must be validated for each customer application by customer's technical experts. SCILLC does not convey any license under its patent rights nor the rights of others. SCILLC products are not designed, intended, or authorized for use as components in systems intended for surgical implant into the body, or other applications intended to support or sustain life, or for any other application in which the failure of the SCILLC product could create a situation where personal injury or death may occur. Should Buyer purchase or use SCILLC products for any such unintended or unauthorized application, Buyer shall indemnify and hold SCILLC and its officers, employees, subsidiaries, affiliates, and distributors harmless against all claims, costs, damages, and expenses, and reasonable attorney fees arising out of, directly or indirectly, any claim of personal injury or death associated with such unintended or unauthorized use, even if such claim alleges that SCILLC was negligent regarding the design or manufacture of the part. SCILLC is an Equal Opportunity/Affirmative Action Employer. This literature is subject to all applicable copyright laws and is not for resale in any manner.

## PUBLICATION ORDERING INFORMATION

### LITERATURE FULFILLMENT:

Literature Distribution Center for ON Semiconductor  
P.O. Box 5163, Denver, Colorado 80217 USA  
**Phone:** 303-675-2175 or 800-344-3860 Toll Free USA/Canada  
**Fax:** 303-675-2176 or 800-344-3867 Toll Free USA/Canada  
**Email:** [orderlit@onsemi.com](mailto:orderlit@onsemi.com)

**N. American Technical Support:** 800-282-9855  
Toll Free USA/Canada  
**Europe, Middle East and Africa Technical Support:**  
Phone: 421 33 790 2910  
**Japan Customer Focus Center**  
Phone: 81-3-5773-3850

ON Semiconductor Website: [www.onsemi.com](http://www.onsemi.com)  
Order Literature: <http://www.onsemi.com/orderlit>  
For additional information, please contact your local Sales Representative

Компания «Life Electronics» занимается поставками электронных компонентов импортного и отечественного производства от производителей и со складов крупных дистрибьюторов Европы, Америки и Азии.

С конца 2013 года компания активно расширяет линейку поставок компонентов по направлению коаксиальный кабель, кварцевые генераторы и конденсаторы (керамические, пленочные, электролитические), за счёт заключения дистрибьюторских договоров

Мы предлагаем:

- Конкурентоспособные цены и скидки постоянным клиентам.
- Специальные условия для постоянных клиентов.
- Подбор аналогов.
- Поставку компонентов в любых объемах, удовлетворяющих вашим потребностям.
- Приемлемые сроки поставки, возможна ускоренная поставка.
- Доставку товара в любую точку России и стран СНГ.
- Комплексную поставку.
- Работу по проектам и поставку образцов.
- Формирование склада под заказчика.
- Сертификаты соответствия на поставляемую продукцию (по желанию клиента).
- Тестирование поставляемой продукции.
- Поставку компонентов, требующих военную и космическую приемку.
- Входной контроль качества.
- Наличие сертификата ISO.

В составе нашей компании организован Конструкторский отдел, призванный помогать разработчикам, и инженерам.

Конструкторский отдел помогает осуществить:

- Регистрацию проекта у производителя компонентов.
- Техническую поддержку проекта.
- Защиту от снятия компонента с производства.
- Оценку стоимости проекта по компонентам.
- Изготовление тестовой платы монтаж и пусконаладочные работы.



Тел: +7 (812) 336 43 04 (многоканальный)  
Email: [org@lifeelectronics.ru](mailto:org@lifeelectronics.ru)