

## Power line chokes

Current-compensated ring core double chokes  
250 V AC, 0.5 ... 6.8 mH, 4.3 ... 10 A, +70 °C / +80 °C

**Series/Type:**            **B82724J2\*U**

**Date:**                    July 2015



© EPCOS AG 2015. Reproduction, publication and dissemination of this publication, enclosures hereto and the information contained therein without EPCOS' prior express consent is prohibited.

EPCOS AG is a TDK Group Company.

**Rated voltage 250 V AC**
**Rated inductance 0.5 ... 6.8 mH**
**Rated current 4.3 ... 10 A / +70 °C / +80 °C**
**Construction**

- Current-compensated ring core double chokes
- Ferrite core with epoxy coating (UL 94 V-0)
- Plastic case (UL 94 V-0, CTI600)
- Full potting (UL 94 V-0, CTI600)
- Sector winding

**Features**

- High resonance frequency due to special winding technique
- Approx. 0.1 ... 1.0% stray inductance for symmetrical interference suppression
- High rated currents and rated temperatures
- Suitable for wave soldering
- Design complies with EN 60938-2 (VDE 0565-2) and UL 1283
- UL<sup>1)</sup> and VDE/ ENEC (VDE) approvals   
- Construction approved to EN 60335-1 (VDE 0700-1)<sup>2)</sup>
- RoHS-compatible

**Applications**

- Suppression of common-mode interferences
- Switch-mode power applications
- Household appliances (white goods)
- Frequency converters for motor control and drives

**Terminals**

- Base material CuNi18Zn290
- Layer composition Ni, Sn
- Pins 0.7 mm x 0.7 mm
- Lead spacing 15 mm x 12.5 mm

**Marking**

Product brand, electrical insulation system designation, ordering code, rated voltages, rated inductance, rated current, date of manufacture (YYWWD.internal ID code), production place identification code

**Delivery mode**

- Blister tray in cardboard box

1) UL approval with 300 V AC

2) Certified values:

|  |                              |
|--|------------------------------|
| Glow wire test (GWT to IEC 60695-2-11):    | +750 °C, 2 s / +850 °C, 30 s |
| Tracking index (PTI[A] to IEC 60112):      | ≥ 250 V                      |
| Ball pressure test (BP to IEC 60695-10-2): | +125 °C                      |

Dimensional drawings and pin configurations

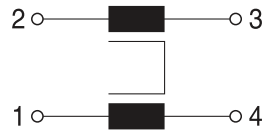
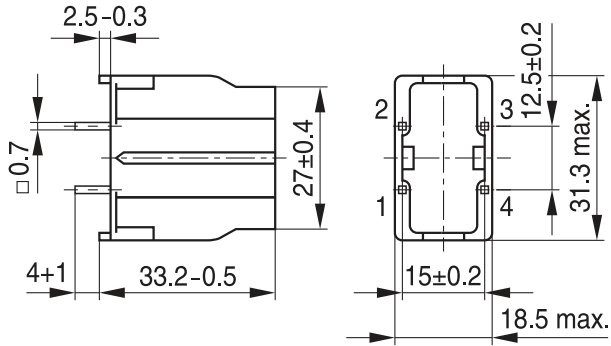

IND0259-1

Part tolerances to ISO 2768-cL / ISO 8015.

Size ISO 14405 (E)

All dimensions in mm

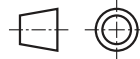



IND1276-L-E

**Technical data and measuring conditions**

|   |   |
|---|---|
| Rated voltage $V_R$                           | 250 V AC (50 / 60 Hz)   |
| Test voltage $V_{test}$                       | 1500 V AC, 2 s (line/line)  |
| Rated temperature $T_R$                       | +70 °C / +80 °C   |
| Rated current $I_R$                           | Referred to 50 Hz and rated temperature   |
| Rated inductance $L_R$                        | Measured with Agilent 4284A at 0.1 mA, +20 °C<br>Measuring frequency: $L_R \leq 1$ mH: $f = 100$ kHz<br>$L_R > 1$ mH: $f = 10$ kHz<br>Inductance is specified per winding |
| Inductance tolerance                          | $\pm 30\%$ at +20 °C  |
| Inductance decrease $\Delta L/L_0$            | < 10% at DC magnetic bias with $I_R$ , +20 °C   |
| Stray inductance $L_{stray,typ}$              | Measured with Agilent 4284A at 5 mA, +20 °C, typical values<br>Measuring frequency: $L_R \leq 1$ mH: $f = 100$ kHz<br>$L_R > 1$ mH: $f = 10$ kHz                          |
| DC resistance $R_{typ}$                       | Measured at +20 °C, typical values, specified per winding   |
| Solderability (lead-free)                     | Sn96.5Ag3.0Cu0.5: $+(245 \pm 5)$ °C, $(3 \pm 0.3)$ s<br>Wetting of soldering area $\geq 95\%$ (to IEC 60068-2-20, test Ta)  |
| Resistance to soldering heat (wave soldering) | $+(260 \pm 5)$ °C, $(10 \pm 1)$ s<br>(to IEC 60068-2-20, test Tb)   |
| Climatic category <sup>1)</sup>               | 40/125/56 (to IEC 60068-1)  |
| Pollution degree                              | P3 (to IEC 61558-1)   |
| Storage conditions (packaged)                 | -25 °C ... +40 °C, $\leq 75\%$ RH   |
| Approvals                                     | EN 60938-2, UL 1283   |

1) Operating temperature: -40 °C ... +125 °C, UL approval only with max. +115 °C  
(see also the curve "Current derating vs. temperature" in this data sheet)

**Characteristics and ordering codes**

| $I_R$<br>A | $L_R$<br>mH | $L_{stray,typ}$<br>$\mu$ H | $R_{typ}$<br>m $\Omega$ | $T_R$<br>°C | Ordering code   | Approvals   |   |
|------------|-------------|----------------------------|-------------------------|-------------|-----------------|---|---|
|            |             |                            |                         |             |                 |  |  |
| 4.3        | 6.8         | 31                         | 50                      | +70         | B82724J2432U040 | ×   | ×   |
| 4.5        | 2.7         | 25                         | 36                      | +80         | B82724J2452U020 | ×   | ×   |
| 5.0        | 5.3         | 25                         | 36                      | +70         | B82724J2502U040 | ×   | ×   |
| 6.0        | 4.0         | 20                         | 25                      | +70         | B82724J2602U040 | ×   | ×   |
| 10.0       | 0.5         | 3.5                        | 9                       | +70         | B82724J2103U040 | ×   | ×   |

**Impedance |Z| versus frequency f**  
 measured with windings in parallel at +20 °C,  
 typical values

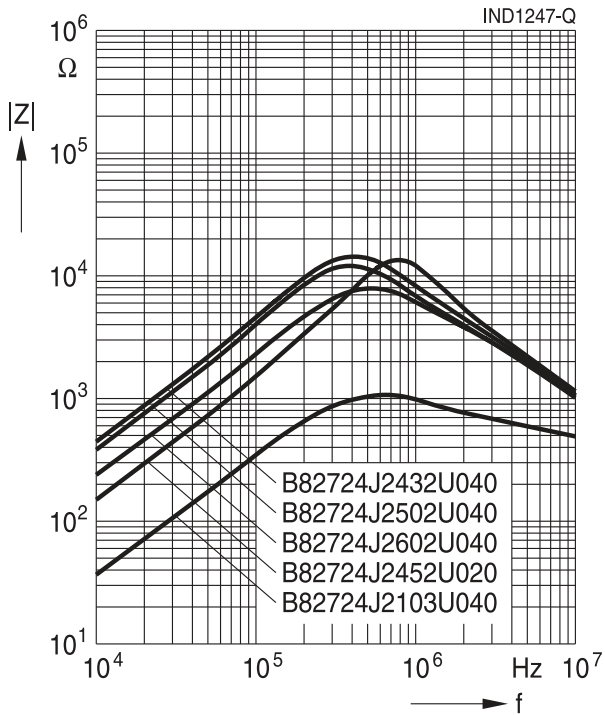

**Current derating  $I_{op}/I_R$**   
**versus ambient temperature  $T_A$**   
 rated temperature  $T_R = +70\text{ °C} / +80\text{ °C}$   
 standard:

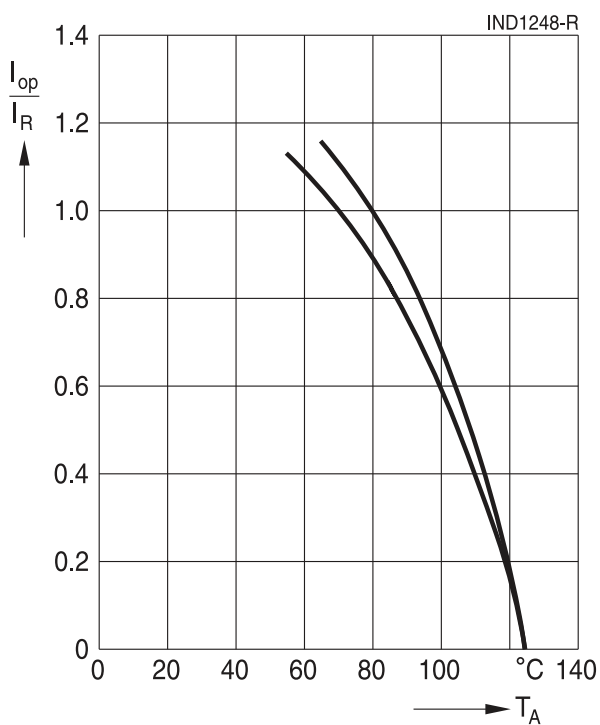

**Current derating  $I_{op}/I_R$**   
**versus ambient temperature  $T_A$**   
 rated temperature  $T_R = +70\text{ °C} / +80\text{ °C}$   
 UL approval:

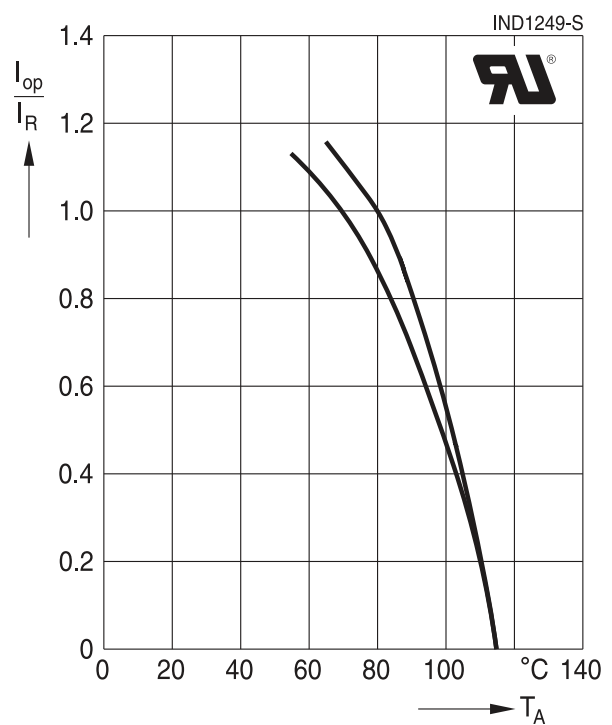

## Cautions and warnings

- Please note the recommendations in our Inductors data book (latest edition) and in the data sheets.
  - Particular attention should be paid to the derating curves given there.
  - The soldering conditions should also be observed. Temperatures quoted in relation to wave soldering refer to the pin, not the housing.
- If the components are to be washed varnished it is necessary to check whether the washing varnish agent that is used has a negative effect on the wire insulation, any plastics that are used, or on glued joints. In particular, it is possible for washing varnish agent residues to have a negative effect in the long-term on wire insulation.  
Washing processes may damage the product due to the possible static or cyclic mechanical loads (e.g. ultrasonic cleaning). They may cause cracks to develop on the product and its parts, which might lead to reduced reliability or lifetime.
- The following points must be observed if the components are potted in customer applications:
  - Many potting materials shrink as they harden. They therefore exert a pressure on the plastic housing or core. This pressure can have a deleterious effect on electrical properties, and in extreme cases can damage the core or plastic housing mechanically.
  - It is necessary to check whether the potting material used attacks or destroys the wire insulation, plastics or glue.
  - The effect of the potting material can change the high-frequency behaviour of the components.
- Ferrites are sensitive to direct impact. This can cause the core material to flake, or lead to breakage of the core.
- Even for customer-specific products, conclusive validation of the component in the circuit can only be carried out by the customer.

### Display of ordering codes for EPCOS products

The ordering code for one and the same product can be represented differently in data sheets, data books, other publications and the website of EPCOS, or in order-related documents such as shipping notes, order confirmations and product labels. **The varying representations of the ordering codes are due to different processes employed and do not affect the specifications of the respective products.** Detailed information can be found on the Internet under [www.epcos.com/orderingcodes](http://www.epcos.com/orderingcodes).

## Important notes

The following applies to all products named in this publication:

1. Some parts of this publication contain **statements about the suitability of our products for certain areas of application**. These statements are based on our knowledge of typical requirements that are often placed on our products in the areas of application concerned. We nevertheless expressly point out **that such statements cannot be regarded as binding statements about the suitability of our products for a particular customer application**. As a rule we are either unfamiliar with individual customer applications or less familiar with them than the customers themselves. For these reasons, it is always ultimately incumbent on the customer to check and decide whether a product with the properties described in the product specification is suitable for use in a particular customer application.
2. We also point out that **in individual cases, a malfunction of electronic components or failure before the end of their usual service life cannot be completely ruled out in the current state of the art, even if they are operated as specified**. In customer applications requiring a very high level of operational safety and especially in customer applications in which the malfunction or failure of an electronic component could endanger human life or health (e.g. in accident prevention or life-saving systems), it must therefore be ensured by means of suitable design of the customer application or other action taken by the customer (e.g. installation of protective circuitry or redundancy) that no injury or damage is sustained by third parties in the event of malfunction or failure of an electronic component.
3. **The warnings, cautions and product-specific notes must be observed.**
4. In order to satisfy certain technical requirements, **some of the products described in this publication may contain substances subject to restrictions in certain jurisdictions (e.g. because they are classed as hazardous)**. Useful information on this will be found in our Material Data Sheets on the Internet ([www.tdk-electronics.tdk.com/material](http://www.tdk-electronics.tdk.com/material)). Should you have any more detailed questions, please contact our sales offices.
5. We constantly strive to improve our products. Consequently, **the products described in this publication may change from time to time**. The same is true of the corresponding product specifications. Please check therefore to what extent product descriptions and specifications contained in this publication are still applicable before or when you place an order.  
  
We also **reserve the right to discontinue production and delivery of products**. Consequently, we cannot guarantee that all products named in this publication will always be available. The aforementioned does not apply in the case of individual agreements deviating from the foregoing for customer-specific products.
6. Unless otherwise agreed in individual contracts, **all orders are subject to our General Terms and Conditions of Supply**.
7. **Our manufacturing sites serving the automotive business apply the IATF 16949 standard**. The IATF certifications confirm our compliance with requirements regarding the quality management system in the automotive industry. Referring to customer requirements and customer specific requirements ("CSR") TDK always has and will continue to have the policy of respecting individual agreements. Even if IATF 16949 may appear to support the acceptance of unilateral requirements, we hereby like to emphasize that **only requirements mutually agreed upon can and will be implemented in our Quality Management System**. For clarification purposes we like to point out that obligations from IATF 16949 shall only become legally binding if individually agreed upon.
8. The trade names EPCOS, CeraCharge, CeraDiode, CeraLink, CeraPad, CeraPlas, CSMP, CTVS, DeltaCap, DigiSiMic, ExoCore, FilterCap, FormFit, LeaXield, MiniBlue, MiniCell, MKD, MKK, MotorCap, PCC, PhaseCap, PhaseCube, PhaseMod, PhiCap, PowerHap, PQSine, PQvar, SIFERRIT, SIFI, SIKOREL, SilverCap, SIMDAD, SiMic, SIMID, SineFormer, SIOV, ThermoFuse, WindCap are **trademarks registered or pending** in Europe and in other countries. Further information will be found on the Internet at [www.tdk-electronics.tdk.com/trademarks](http://www.tdk-electronics.tdk.com/trademarks).

Release 2018-10

# Mouser Electronics

Authorized Distributor

Click to View Pricing, Inventory, Delivery & Lifecycle Information:

[EPCOS / TDK:](#)

[B82724J2103U040](#) [B82724J2602U040](#) [B82724J2502U040](#) [B82724J2452U020](#) [B82724J2432U040](#)



Компания «Life Electronics» занимается поставками электронных компонентов импортного и отечественного производства от производителей и со складов крупных дистрибьюторов Европы, Америки и Азии.

С конца 2013 года компания активно расширяет линейку поставок компонентов по направлению коаксиальный кабель, кварцевые генераторы и конденсаторы (керамические, пленочные, электролитические), за счёт заключения дистрибьюторских договоров

Мы предлагаем:

- Конкуренеспособные цены и скидки постоянным клиентам.
- Специальные условия для постоянных клиентов.
- Подбор аналогов.
- Поставку компонентов в любых объемах, удовлетворяющих вашим потребностям.
- Приемлемые сроки поставки, возможна ускоренная поставка.
- Доставку товара в любую точку России и стран СНГ.
- Комплексную поставку.
- Работу по проектам и поставку образцов.
- Формирование склада под заказчика.
- Сертификаты соответствия на поставляемую продукцию (по желанию клиента).
- Тестирование поставляемой продукции.
- Поставку компонентов, требующих военную и космическую приемку.
- Входной контроль качества.
- Наличие сертификата ISO.

В составе нашей компании организован Конструкторский отдел, призванный помогать разработчикам, и инженерам.

Конструкторский отдел помогает осуществить:

- Регистрацию проекта у производителя компонентов.
- Техническую поддержку проекта.
- Защиту от снятия компонента с производства.
- Оценку стоимости проекта по компонентам.
- Изготовление тестовой платы монтаж и пусконаладочные работы.



Тел: +7 (812) 336 43 04 (многоканальный)

Email: [org@lifeelectronics.ru](mailto:org@lifeelectronics.ru)