

# RTE Series Low Profile Rotary DIP Switches



H  
DIP

## Features/Benefits

- Thru-hole and surface mount models
- Miniature size with robust metal cover in black or silver nickel finish
- 4, 10, & 16 positions
- Large choice of codings
- Vertical, right angle or reverse versions
- RoHS compliant

## Typical Applications

- Timers, automation components
- Computer and peripherals
- Alarms, access control, smoke detectors, lighting, home protection
- Instrumentation



## Specifications

### CONTACT RATING:

Gold: 100 mA max. 10 $\mu$  A min. 30 V DC max. 20 mVDC min.

MECHANICAL LIFE: 20,000 indexations

CONTACT RESISTANCE: 100 m $\Omega$  max. initial;  
150 m $\Omega$  after life

INSULATION RESISTANCE: 10<sup>10</sup>  $\Omega$  min. initial

DIELECTRIC STRENGTH: 300 Vrms 1 mn

OPERATING TEMPERATURE: -25°C to 85°C.

STORAGE TEMPERATURE: -55°C to 85°C.

### PACKAGING:

Quantities

Terminations	Actuator	Tube	Box (in bulk)	Carrier tape	Standard Package
G	Flush, screwdriver slot			1250	1250 (1 reel)
	Shaft for button			750	750 (1 reel)
N	All versions	65			1950 (30 tubes)
V	All versions		150		1500 (10 boxes)
R	Flush, screwdriver slot	65			1950 (30 tubes)
	Shaft for button		150		1500 (10 boxes)

## Materials

COVER: Brass, nickel plated (black or silver)

BASE: PPS

ACTUATOR: LCP

MOVABLE CONTACTS: Copper alloy, gold plated.

STATIONARY CONTACTS: Brass, gold plated.

TERMINALS: See page I-28 to I-29

O-RING: Silicone

### SOLDERING PROCESS:

- Surface Mount Terminals: Infrared Reflow Soldering in accordance with IEC 61760-1.

- Non Reverse Thru-Hole Terminals: Lead free single or double wave soldering process according to C&K Procedure PS-LF-001

- Reverse Thru-Hole Terminals: Manual soldering: 3 sec / 350°C. Lead free single wave soldering process can be used but validation of the process must be done by customer

**Note:** Specifications and materials listed above are for switches with standard options. For information on specific and custom switches, consult Customer Service Center.

## How To Order

The Build-A Switch concept allows you to mix and match options to create the switch you need. Below is a complete listing of options shown in catalog. To order, simply select desired option from each category and place in the appropriate box.

**NOTE:** Some of the configurations may not be available or could require some development.



Number of Positions

- RTE04**    **ESD Protection and top plate**
- RTE10**    **0** Without ESD - standard plate
- RTE16**    **1** With ESD - standard plate <sup>2</sup>
- B** Without ESD - black plate

- Actuator**
- 0** Flush, screwdriver slot
- 2** Shaft for button

- Terminations**
- N** Thru-hole
- V** Right angle
- G** Surface mount
- R** Reverse, thru-hole

- Switch Function**
- 0** Single pole <sup>1</sup>
- 1** BCD code
- 3** Gray Code (for RTE 10)
- 4** Hexadecimal code (for RTE 16)
- 7** Gray Code (for RTE 16)

- Contact/Terminal Material**
- 4** Gold 0.5  $\mu$ m/ lead free tin
- 7** Gold 1.0  $\mu$ m



First Angle  
Projection

1 - Single pole function not available for RTE10/RTE16  
2 - ESD protection available with "N" and "R" terminations only

# RTE Series Low Profile Rotary DIP Switches

## SWITCHES WITH STANDARD OPTIONS

### PC Mount-Terminal Option N

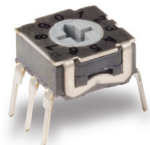

### Right Angle Mount-Terminal Option V

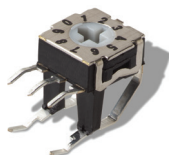

### Surface Mount-Terminal Option G



## NUMBER OF POSITIONS

### RTE04 4 POSITIONS



### RTE10 10 POSITIONS

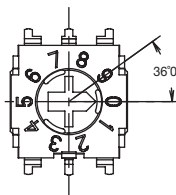

### RTE16 16 POSITIONS

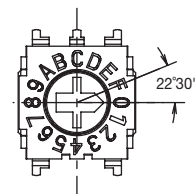

# RTE Series Low Profile Rotary DIP Switches



H  
DIP

## ESD PROTECTION

0 WITHOUT



1 WITH

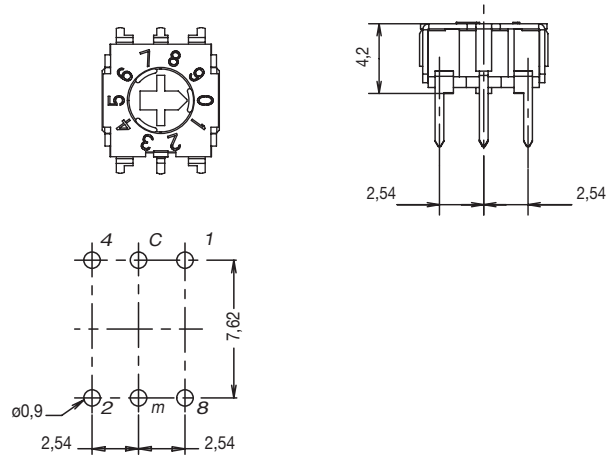

## ACTUATOR

0 SCREWDRIVER SLOT



For all RTE versions



Except for RTE1000Gx4 (SMT)  
RTE1600Gx4 (SMT)



2 SHAFT FOR BUTTON



Dimensions are shown: Inch (mm)  
Specifications and dimensions subject to change



8 Nov 2019

# RTE Series Low Profile Rotary DIP Switches

## TERMINATIONS

TERMINATIONS

DIP I

### N THRU-HOLE



### R REVERSE, THRU-HOLE



### V RIGHT ANGLE, THRU-HOLE



### G SURFACE MOUNT

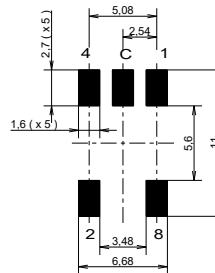
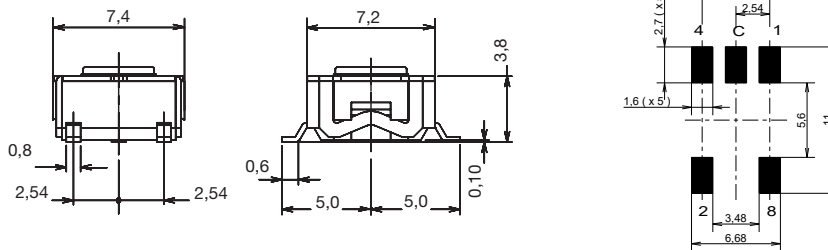

PCB layout seen component side



Dimensions are shown: Inch (mm)  
Specifications and dimensions subject to change



### SWITCH FUNCTION

#### 0 SINGLE POLE

POS.	1	2	3	4
C	●	●	●	●
1	●			
2		●		
3			●	
4				●

#### 1 BCD CODE

POS.	0	1	2	3	4	5	6	7	8	9
C	●	●	●	●	●	●	●	●	●	●
1		●						●		●
2			●	●			●	●		
4					●	●	●	●		
8									●	●

#### 3 GRAY CODE ( for RTE10 only )

POS.	0	1	2	3	4	5	6	7	8	9
C	●	●	●	●	●	●	●	●	●	●
1		●	●			●	●			●
2			●	●	●					
4				●	●	●	●	●	●	●
8									●	●

#### 4 HEXADECIMAL CODE

POS.	0	1	2	3	4	5	6	7	8	9	A	B	C	D	E	F
C	●	●	●	●	●	●	●	●	●	●	●	●	●	●	●	●
1		●				●	●		●		●		●		●	
2			●	●			●	●			●		●		●	
4					●	●	●	●				●	●	●	●	
8									●	●	●	●	●	●	●	

#### 7 GRAY CODE (for RTE04 only)

POS.	1	2	3	4
C	●	●	●	●
1	●			
2		●		
4			●	
8				●

(for RTE16 only)

POS.	0	1	2	3	4	5	6	7	8	9	A	B	C	D	E	F
C	●	●	●	●	●	●	●	●	●	●	●	●	●	●	●	●
1		●	●			●	●		●		●		●		●	
2			●	●	●	●			●		●		●		●	
4				●	●	●	●	●	●	●	●		●		●	
8									●	●	●	●	●	●	●	

### CONTACT MATERIAL

OPTION CODE	CONTACT MATERIAL	TERMINAL PLATING
4	Gold	0.5 µm / lead free tin
7	Gold	1.0 µm

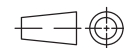

First Angle  
Projection

Dimensions are shown: Inch (mm)  
Specifications and dimensions subject to change

# RTE Series Low Profile Rotary DIP Switches

## TAPE AND REEL

Tape and reel for RTExx02Gxx  
750 pieces per reel.

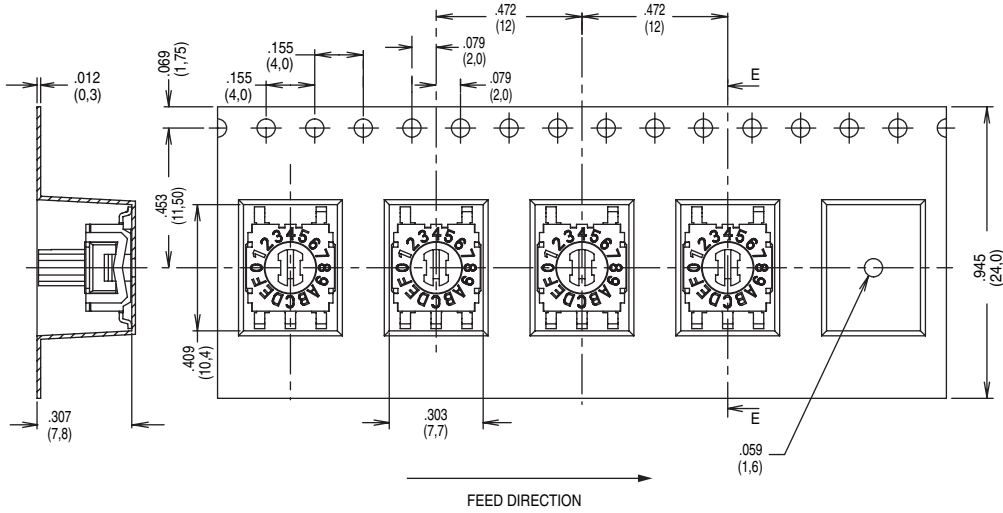

Tape and reel for RTExx00Gxx  
1,250 pieces per reel.



Dimensions are shown: Inch (mm)  
Specifications and dimensions subject to change

Компания «Life Electronics» занимается поставками электронных компонентов импортного и отечественного производства от производителей и со складов крупных дистрибьюторов Европы, Америки и Азии.

С конца 2013 года компания активно расширяет линейку поставок компонентов по направлению коаксиальный кабель, кварцевые генераторы и конденсаторы (керамические, пленочные, электролитические), за счёт заключения дистрибьюторских договоров

Мы предлагаем:

- Конкурентоспособные цены и скидки постоянным клиентам.
- Специальные условия для постоянных клиентов.
- Подбор аналогов.
- Поставку компонентов в любых объемах, удовлетворяющих вашим потребностям.
- Приемлемые сроки поставки, возможна ускоренная поставка.
- Доставку товара в любую точку России и стран СНГ.
- Комплексную поставку.
- Работу по проектам и поставку образцов.
- Формирование склада под заказчика.
- Сертификаты соответствия на поставляемую продукцию (по желанию клиента).
- Тестирование поставляемой продукции.
- Поставку компонентов, требующих военную и космическую приемку.
- Входной контроль качества.
- Наличие сертификата ISO.

В составе нашей компании организован Конструкторский отдел, призванный помогать разработчикам, и инженерам.

Конструкторский отдел помогает осуществить:

- Регистрацию проекта у производителя компонентов.
- Техническую поддержку проекта.
- Защиту от снятия компонента с производства.
- Оценку стоимости проекта по компонентам.
- Изготовление тестовой платы монтаж и пусконаладочные работы.



Тел: +7 (812) 336 43 04 (многоканальный)  
Email: [org@lifeelectronics.ru](mailto:org@lifeelectronics.ru)