

IEC Appliance Outlet F, Integrated Light Pipes, PCB terminals, Color Coding



Light Pipes on N side



Light Pipes N and L side



Example PDU with integrated light Pipes

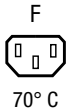

See below:

[Approvals and Compliances](#)

**Description**

- Panel mount :  
 Snap-in version from front side
- Connector , Pin temperature 70 °C , Protection class I
- Pre-assembled light pipes
- For PCB mounting

**Unique Selling Proposition**

- Integrated Light Pipes for status indication
- Optional with one, two or without light pipes
- Ideal appliance outlet for smart PDUs
- Cord retention for V-Lock cordsets and other side latch mechanisms

**Other versions on request**

- Other panel thickness
- Other lengths on terminals and light pipes
- Quick connect or solder terminals (incl. different terminals on L, N, PE)

**References**

Alternative: version without light pipe [6600-4](#)

**Weblinks**

[pdf data sheet](#), [html datasheet](#), [General Product Information](#), [Approvals](#), [Distributor-Stock-Check](#), [Accessories](#), [Detailed request for product](#), [Landing Page](#)

See PDU Landing Page for more information to status indication with Light pipes.

[Power Distribution Units](#)

**Technical Data**

Ratings IEC	10A / 250VAC; 50Hz	Appliance inlet/-outlet	F acc. to IEC 60320-3
Ratings UL/CSA	15A / 250VAC; 60Hz		UL 60320-1, CSA C22.2 no. 60320-1
Dielectric Strength	> 1.5kVAC between L-N > 3kVAC between L/N-PE (1 min/50Hz)		(for cold conditions) pin-temperature 70 °C, 10A, Protection Class I
Allowable Operation Temperature	-25 °C to 70 °C		
IP-Protection	from front side IP20 acc. to IEC 60529		
Protection against electric shock	Suitable for appliances with protection class I acc. to IEC 61140		
Terminal	For PCB mounting		
Panel Thickness S	Snap-in: 1.7 / 2 mm		
Material: Housing	Thermoplastic, black, UL 94V-0		

**Approvals and Compliances**

Detailed information on product approvals, code requirements, usage instructions and detailed test conditions can be looked up in [Details about Approvals](#)

SCHURTER products are designed for use in industrial environments. They have approvals from independent testing bodies according to national and international standards. Products with specific characteristics and requirements such as required in the automotive sector according to IATF 16949, medical technology according to ISO 13485 or in the aerospace industry can be offered exclusively with customer-specific, individual agreements by SCHURTER.

**Approvals**



The approval mark is used by the testing authorities to certify compliance with the safety requirements placed on electronic products.

Approval Reference Type: 6600-5

Approval Logo	Certificates	Certification Body	Description
	<a href="#">VDE Approvals</a>	VDE	Certificate Number: 40044597
	<a href="#">UL Approvals</a>	UL	UL File Number: E103791
	<a href="#">CCC Approvals</a>	CCC	CCC Certificate Number: 2018180204005386



## Product standards

Product standards that are referenced

Organization	Design	Standard	Description
	Designed according to	IEC 60320-3	Appliance couplers for household and similar general purposes
	Designed according to	UL 60320-1	Standard for Attachment Plugs and Receptacles
	Designed according to	CSA C22.2 no. 60320-1	General Use Receptacles, Attachment Plugs, and Similar Wiring Devices







## Application standards

Application standards where the product can be used

Organization	Design	Standard	Description
	Designed for applications acc.	IEC/UL 62368-1	IEC 62368-1 includes the basic requirements for safety of audio, video, information technology and office equipment.
	Designed for applications acc.	IEC 60335-1	Safety of electrical appliances for household and similar purposes. Meets the requirements for appliances in unattended use. This includes the enhanced requirements of glow wire tests acc. to IEC 60695-2-11 or -12 & -13.

## Compliances

The product complies with following Guide Lines

Identification	Details	Initiator	Description
	<a href="#">CE declaration of conformity</a>	SCHURTER AG	The CE marking declares that the product complies with the applicable requirements laid down in the harmonisation of Community legislation on its affixing in accordance with EU Regulation 765/2008.
	RoHS	SCHURTER AG	Directive RoHS 2011/65/EU, Amendment (EU) 2015/863
	China RoHS	SCHURTER AG	The law SJ / T 11363-2006 (China RoHS) has been in force since 1 March 2007. It is similar to the EU directive RoHS.
	REACH	SCHURTER AG	On 1 June 2007, Regulation (EC) No 1907/2006 on the Registration, Evaluation, Authorization and Restriction of Chemicals 1 (abbreviated as "REACH") entered into force.
	<a href="#">Landing Page V-Lock</a>	SCHURTER AG	V-Lock system are based on a matching plug-dose combination. The connector is equipped with a notch intended for use with the latching cordset. The cord latching system prevents against accidental removal of the cordset.
	<a href="#">White Paper Glow wire test</a>	SCHURTER AG	Meets the requirements of IEC 60335-1 for appliances in unattended use. This includes the enhanced requirements of glow wire tests acc. to IEC 60695-2-11 or -12 & -13.

Dimensions [mm]

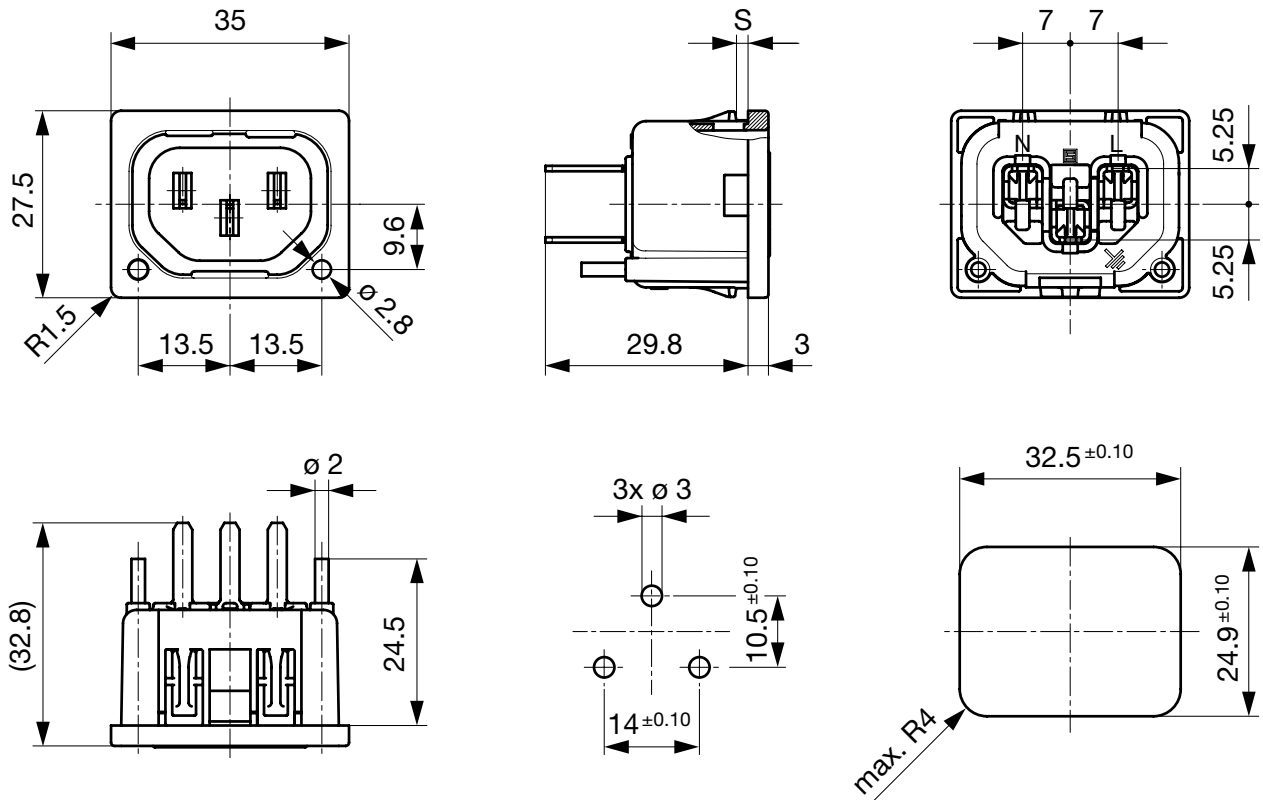

See Application Note for more information to status indication with Light pipes.  
[Application Note](#)

All Variants

Panel Thickness	Terminal	Light pipe N side	Light pipe L side	Order Number
2.0	PCB			<a href="#">3-101-689</a>
2.0	PCB		●	<a href="#">3-101-686</a>
2.0	PCB	●		<a href="#">3-101-687</a>
2.0	PCB	●	●	<a href="#">3-101-685</a>
1.7	PCB			<a href="#">3-100-406</a>
1.7	PCB		●	<a href="#">3-100-404</a>
1.7	PCB	●		<a href="#">3-100-405</a>
1.7	PCB	●	●	<a href="#">3-100-403</a>

Most Popular.

Availability for all products can be searched real-time: <https://www.schurter.com/en/Stock-Check/Stock-Check-SCHURTER>

Packaging unit 50 Pcs



6600-5 packed in cardboard box with holes

**Mating Inlets/Plugs**

**Category / Description**

[Plug Overview complete](#)



4732, Mounting: Power Cord, Plug: IEC E, Cable	4732
4735, Mounting: Power Cord, Plug: IEC E, Cable	4735
9009, Mounting: Plug: IEC E, Screw clamps	9009
4733, Mounting: Power Cord, Plug: IEC E, Cable	4733
4736, Mounting: Power Cord, Plug: IEC E, Cable	4736
<a href="#">Plug further types to 6600-5</a>	...

**Mating Inlets/Plugs shuttered**

[Interconnection Cord Overview complete](#)



VAC13KS, Interconnection, V-Lock cord retaining, 0.6 m, Connector IEC C13, H05VV-F3G0.75 / SVT 3x18 AWG, black	3-100-354
VAC13KS, Interconnection, V-Lock cord retaining, 1.2 m, Connector IEC C13, H05VV-F3G0.75 / SVT 3x18 AWG, black	3-100-355
VAC13KS, Interconnection, V-Lock cord retaining, 1.5 m, Connector IEC C13, H05VV-F3G0.75 / SVT 3x18 AWG, black	3-100-356
VAC13KS, Interconnection, V-Lock cord retaining, 3.0 m, Connector IEC C13, SVT 3x18 AWG, black	3-100-361
VAC13KS, Interconnection, V-Lock cord retaining, 1.8 m, Connector IEC C13, H05VV-F3G0.75 / SVT 3x18 AWG, black	3-100-734
<a href="#">Interconnection Cord further types to 6600-5</a>	...

Компания «Life Electronics» занимается поставками электронных компонентов импортного и отечественного производства от производителей и со складов крупных дистрибьюторов Европы, Америки и Азии.

С конца 2013 года компания активно расширяет линейку поставок компонентов по направлению коаксиальный кабель, кварцевые генераторы и конденсаторы (керамические, пленочные, электролитические), за счёт заключения дистрибьюторских договоров

Мы предлагаем:

- Конкурентоспособные цены и скидки постоянным клиентам.
- Специальные условия для постоянных клиентов.
- Подбор аналогов.
- Поставку компонентов в любых объемах, удовлетворяющих вашим потребностям.
- Приемлемые сроки поставки, возможна ускоренная поставка.
- Доставку товара в любую точку России и стран СНГ.
- Комплексную поставку.
- Работу по проектам и поставку образцов.
- Формирование склада под заказчика.
- Сертификаты соответствия на поставляемую продукцию (по желанию клиента).
- Тестирование поставляемой продукции.
- Поставку компонентов, требующих военную и космическую приемку.
- Входной контроль качества.
- Наличие сертификата ISO.

В составе нашей компании организован Конструкторский отдел, призванный помогать разработчикам, и инженерам.

Конструкторский отдел помогает осуществить:

- Регистрацию проекта у производителя компонентов.
- Техническую поддержку проекта.
- Защиту от снятия компонента с производства.
- Оценку стоимости проекта по компонентам.
- Изготовление тестовой платы монтаж и пусконаладочные работы.



Тел: +7 (812) 336 43 04 (многоканальный)

Email: [org@lifeelectronics.ru](mailto:org@lifeelectronics.ru)