



**Hittite**  
MICROWAVE PRODUCTS  
FROM ANALOG DEVICES

# Analog Devices Welcomes Hittite Microwave Corporation



**THIS PAGE INTENTIONALLY LEFT BLANK**



## GaAs MMIC 6-BIT DIGITAL PHASE SHIFTER, 2.5 - 3.1 GHz

### Typical Applications

The HMC647ALP6E is ideal for:

- EW Receivers
- Weather & Military Radar
- Satellite Communications
- Beamforming Modules
- Phase Cancellation

### Features

- Low RMS Phase Error: 1.5°
- Low Insertion Loss: 4 dB
- High Linearity: +50 dBm
- Positive Control Logic
- 360° Coverage, LSB = 5.625°
- 28 Lead QFN Leadless SMT Package: 36mm<sup>2</sup>

### Functional Diagram

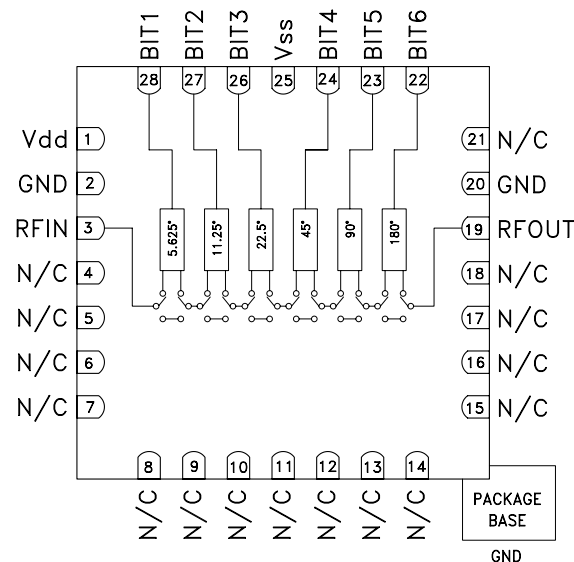

### General Description

The HMC647ALP6E is a 6-bit digital phase shifter which is rated from 2.5 to 3.1 GHz, providing 360 degrees of phase coverage, with a LSB of 5.625 degrees. The HMC647ALP6E features very low RMS phase error of 1.5 degrees and extremely low insertion loss variation of ±0.4 dB across all phase states. This high accuracy phase shifter is controlled with positive control logic of 0/+5V. The HMC647ALP6E is housed in a compact 6x6 mm plastic leadless SMT package and is internally matched to 50 Ohms with no external components.

### Electrical Specifications

$T_A = +25^\circ\text{C}$ ,  $V_{SS} = -5\text{V}$ ,  $V_{DD} = +5\text{V}$ , control Voltage = 0/+5V, 50 Ohm System

Parameter	Min.	Typ.	Max.	Units
Frequency Range	2.5		3.1	GHz
Insertion Loss*		4	6.5	dB
Input Return Loss*		16		dB
Output Return Loss*		16		dB
Phase Error*		±5	+6 / -15	deg
RMS Phase Error		1.5		deg
Insertion Loss Variation*		±0.4		dB
Input Power for 1 dB Compression		31		dBm
Input Third Order Intercept		50		dBm
Control Voltage Current		35	250	µA
Bias Control Current		5	15	mA

\*Note: Major States Shown



**GaAs MMIC 6-BIT DIGITAL  
 PHASE SHIFTER, 2.5 - 3.1 GHz**

**Insertion Loss, Major States Only**

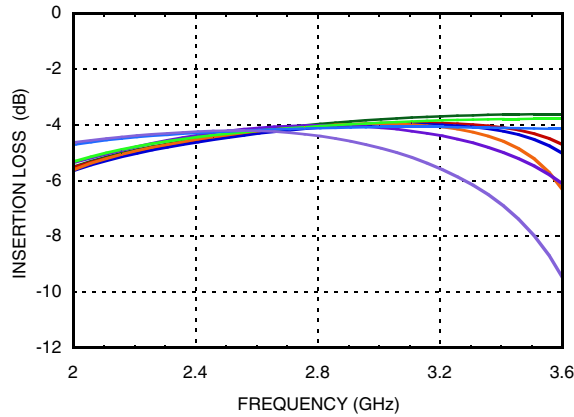

**Normalized Loss, Major States Only**

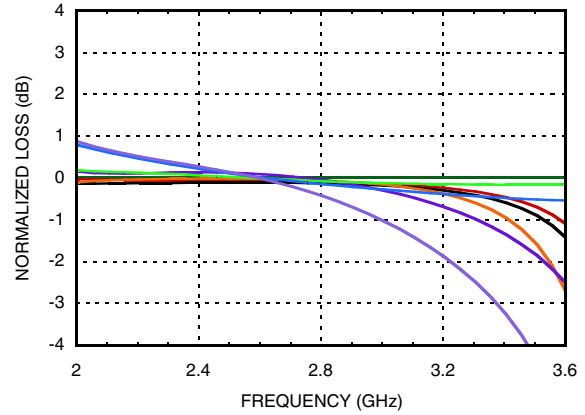

**Input Return Loss, Major States Only**

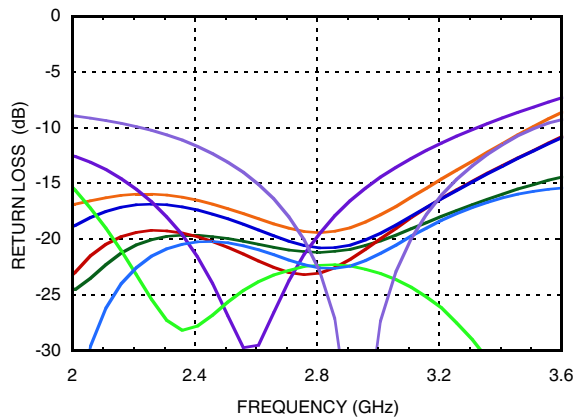

**Phase Error, Major States Only**

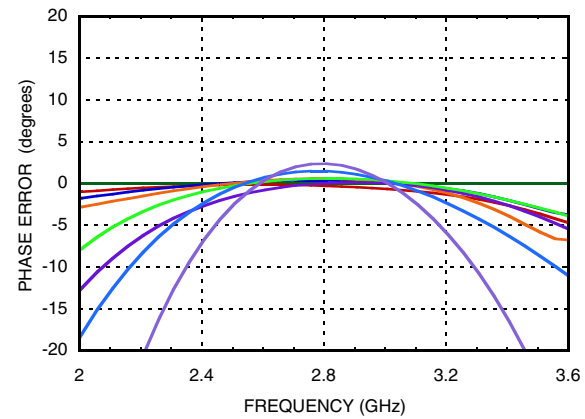

**Output Return Loss, Major States Only**

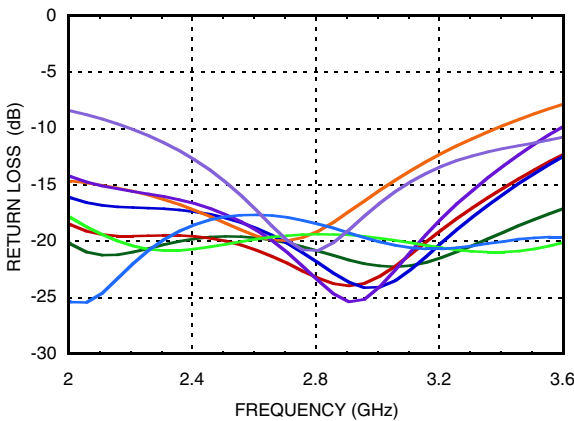

**Relative Phase Shift  
 Major States Including All Bits**

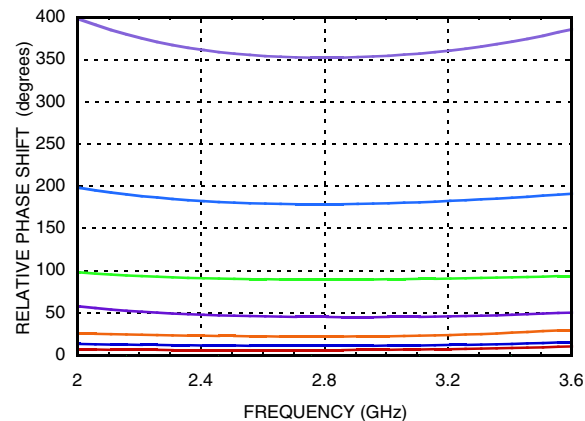



**GaAs MMIC 6-BIT DIGITAL  
 PHASE SHIFTER, 2.5 - 3.1 GHz**

**Relative Phase Shift,  
 RMS, Average, Max, All States**

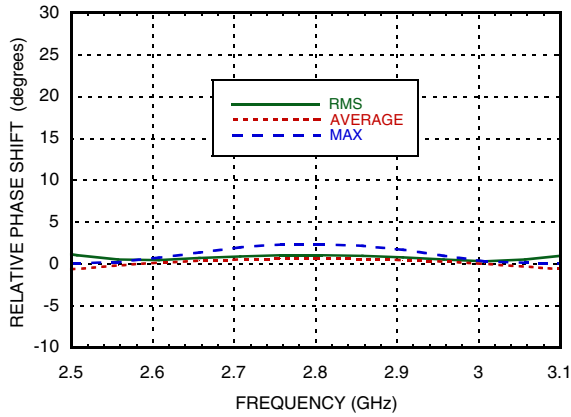

**Input IP3, Major States Only**

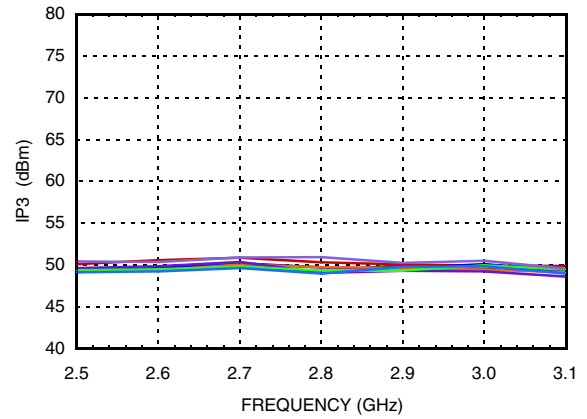

**Input IP2, Major States Only**

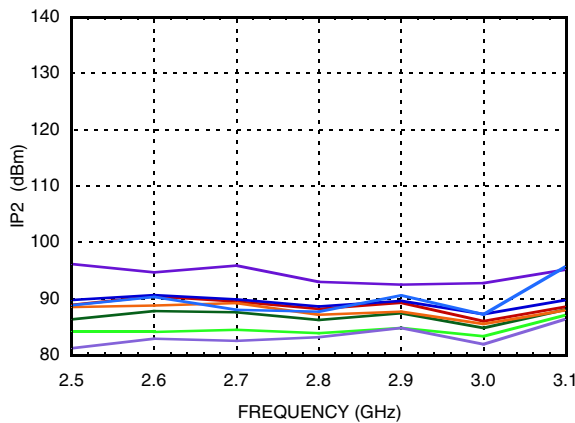

**Input P1dB, Major States Only**

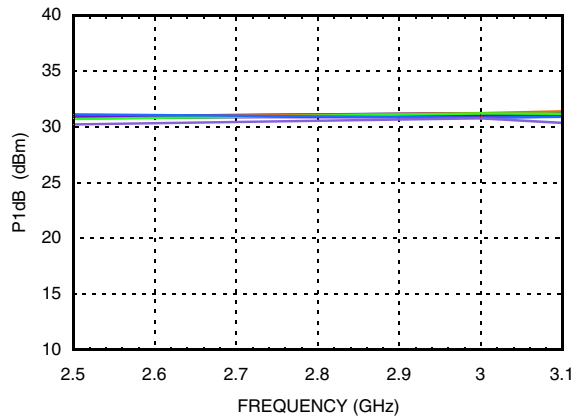

**RMS Phase Error vs. Temperature**

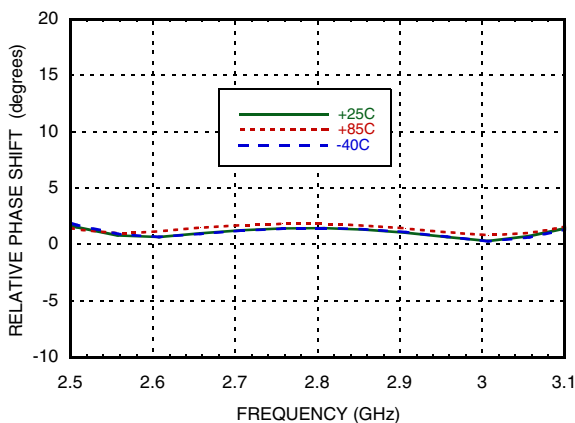

**Insertion Loss vs. Temperature,  
 Major States Only**

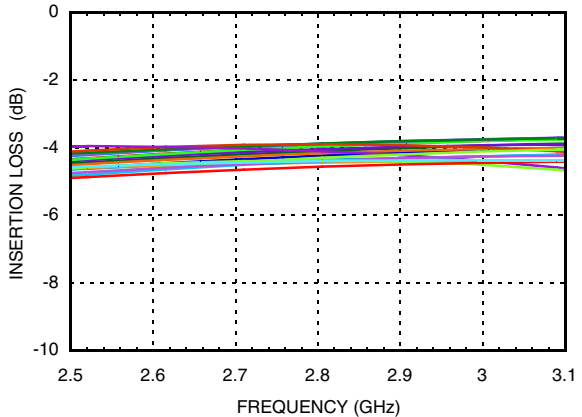



**GaAs MMIC 6-BIT DIGITAL  
PHASE SHIFTER, 2.5 - 3.1 GHz**

**Phase Error vs. State**

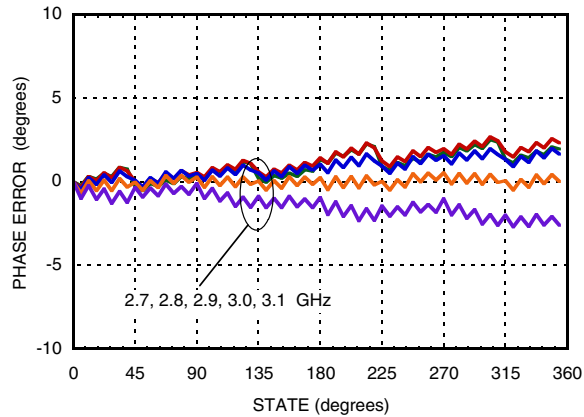

**Bias Voltage & Current**

Vdd	Idd
5.0	5.3mA
Vss	Iss
-5.0	5.3mA

**Control Voltage**

State	Bias Condition
Low (0)	0 to 0.2 Vdc
High (1)	Vdd ±0.2 Vdc @ 35 µA Typ.

**Absolute Maximum Ratings**

Input Power (RFIN)	33 dBm (T= +85 °C)
Bias Voltage Range (Vdd)	-0.2 to +12V
Bias Voltage Range (Vss)	+0.2 to -12V
Channel Temperature (Tc)	150 °C
Thermal Resistance (channel to ground paddle)	128 °C/W
Storage Temperature	-65 to +150 °C
Operating Temperature	-40 to +85 °C
ESD Sensitivity (HBM)	Class1A Passed 250V



**ELECTROSTATIC SENSITIVE DEVICE  
OBSERVE HANDLING PRECAUTIONS**

**Truth Table**

Control Voltage Input						Phase Shift (Degrees) RFIN - RFOUT
Bit 1	Bit 2	Bit 3	Bit 4	Bit 5	Bit 6	
0	0	0	0	0	0	Reference*
1	0	0	0	0	0	5.625
0	1	0	0	0	0	11.25
0	0	1	0	0	0	22.5
0	0	0	1	0	0	45.0
0	0	0	0	1	0	90.0
0	0	0	0	0	1	180.0
1	1	1	1	1	1	354.375

Any combination of the above states will provide a phase shift approximately equal to the sum of the bits selected.  
\*Reference corresponds to monotonic setting

**Outline Drawing**

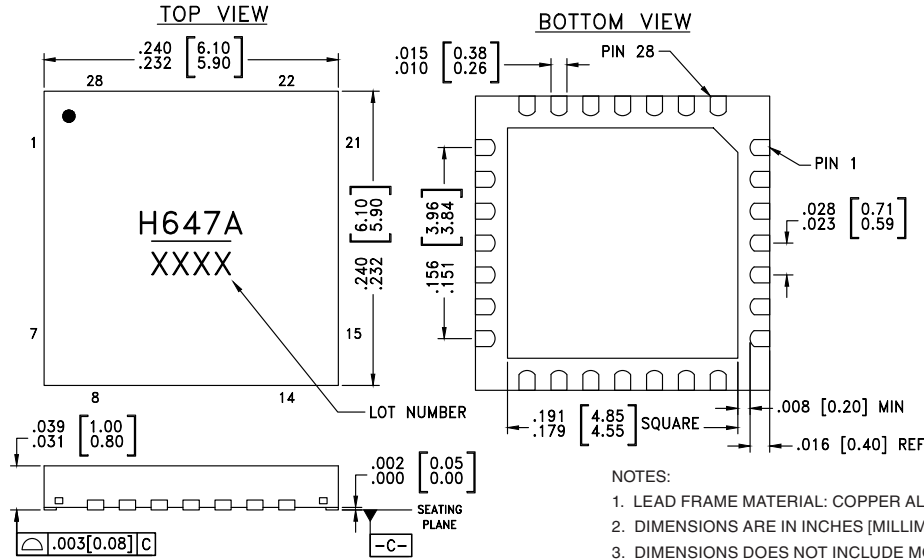

- NOTES:
1. LEAD FRAME MATERIAL: COPPER ALLOY
  2. DIMENSIONS ARE IN INCHES [MILLIMETERS].
  3. DIMENSIONS DOES NOT INCLUDE MOLDFLASH OF 0.15mm PER SIDE
  4. DIMENSIONS DOES NOT INCLUDE MOLDFLASH OF 0.25mm PER SIDE
  5. ALL GROUND LEADS AND GROUND PADDLE MUST BE SOLDERED TO PCB RF GROUND.
  6. CLASSIFIED AS MOISTURE SENSITIVITY LEVEL (MSL) 1.

**Package Information**

Part Number	Package Body Material	Lead Finish	MSL Rating	Package Marking <sup>[2]</sup>
HMC647ALP6E	RoHS-compliant Low Stress Injection Molded Plastic	100% matte Sn	MSL3 <sup>[1]</sup>	H647A XXXX

[1] Max peak reflow temperature of 260 °C  
[2] 4-Digit lot number XXXX

**Pin Descriptions**

Pin Number	Function	Description	Interface Schematic
1	Vdd	Voltage Supply	
2, 20	GND	These pins and exposed ground paddle must be connected to RF/DC ground.	
3	RFIN	This port is DC coupled and matched to 50 Ohms.	
4 - 18, 21	N/C	No connection required. These pins may be connected to RF/DC ground without affecting performance.	
19	RFOUT	This port is DC coupled and matched to 50 Ohms.	
22 - 24 26 - 28	BIT6, BIT5, BIT4, BIT3, BIT2, BIT1	Control Input. See truth table and control voltage tables.	
25	Vss	Voltage Supply	

**Evaluation PCB**

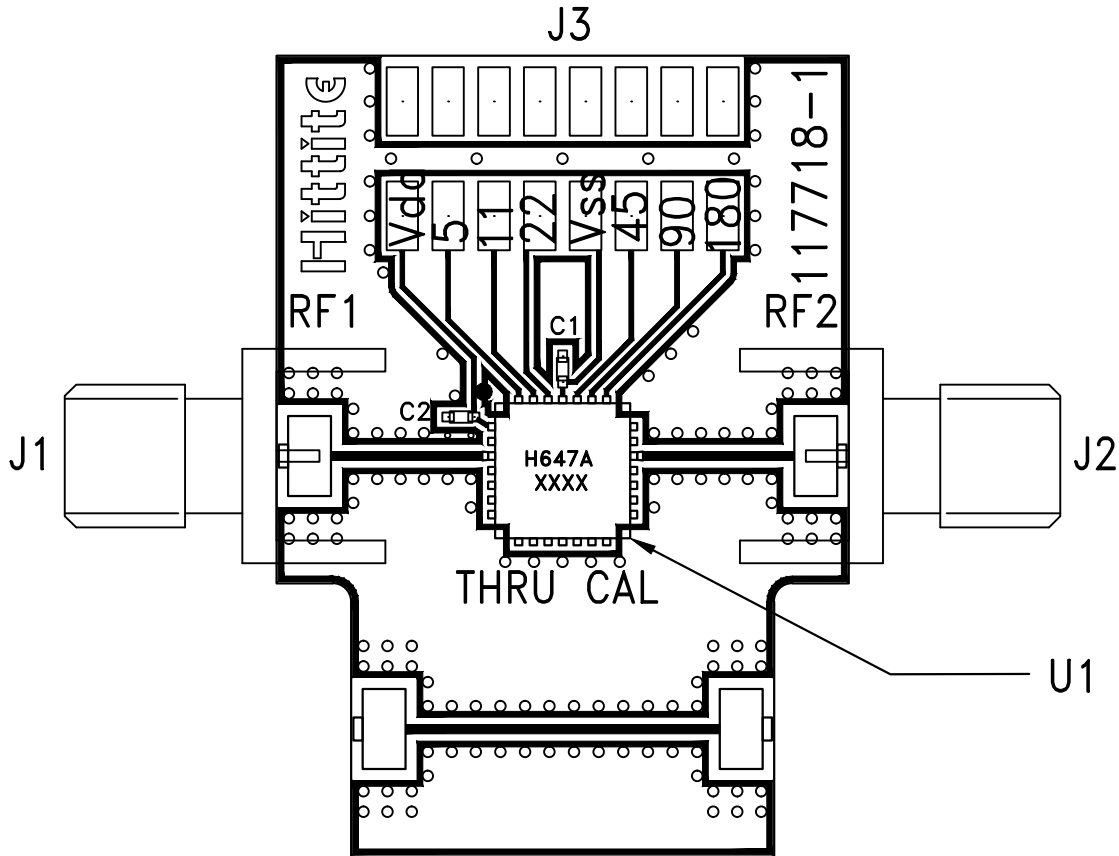

**List of Materials for Evaluation EV1HMC647ALP6 [1][3]**

Item	Description
J1 - J2	PCB Mount SMA RF Connector
J3	Header 2mm, 16 pins
C1, C2	1000pF, 0402 pkg
U1	HMC647ALP6E 6-Bit Digital Phase Shifter
PCB [2]	117718 Evaluation PCB

[1] Reference this number when ordering complete evaluation PCB

[2] Circuit Board Material: Rogers 4350

[3] Please refer to part's pin description and functional diagram for pin out assignments on evaluation board.

The circuit board used in the final application should use RF circuit design techniques. Signal lines should have 50 ohm impedance while the package ground leads and exposed paddle should be connected directly to the ground plane similar to that shown. A sufficient number of via holes should be used to connect the top and bottom ground planes. The evaluation board should be mounted to an appropriate heat sink. The evaluation circuit board shown is available from Hittite upon request.



Компания «Life Electronics» занимается поставками электронных компонентов импортного и отечественного производства от производителей и со складов крупных дистрибьюторов Европы, Америки и Азии.

С конца 2013 года компания активно расширяет линейку поставок компонентов по направлению коаксиальный кабель, кварцевые генераторы и конденсаторы (керамические, пленочные, электролитические), за счёт заключения дистрибьюторских договоров

Мы предлагаем:

- Конкурентоспособные цены и скидки постоянным клиентам.
- Специальные условия для постоянных клиентов.
- Подбор аналогов.
- Поставку компонентов в любых объемах, удовлетворяющих вашим потребностям.
- Приемлемые сроки поставки, возможна ускоренная поставка.
- Доставку товара в любую точку России и стран СНГ.
- Комплексную поставку.
- Работу по проектам и поставку образцов.
- Формирование склада под заказчика.
- Сертификаты соответствия на поставляемую продукцию (по желанию клиента).
- Тестирование поставляемой продукции.
- Поставку компонентов, требующих военную и космическую приемку.
- Входной контроль качества.
- Наличие сертификата ISO.

В составе нашей компании организован Конструкторский отдел, призванный помогать разработчикам, и инженерам.

Конструкторский отдел помогает осуществить:

- Регистрацию проекта у производителя компонентов.
- Техническую поддержку проекта.
- Защиту от снятия компонента с производства.
- Оценку стоимости проекта по компонентам.
- Изготовление тестовой платы монтаж и пусконаладочные работы.



Тел: +7 (812) 336 43 04 (многоканальный)  
Email: [org@lifeelectronics.ru](mailto:org@lifeelectronics.ru)