

Features

Regulated Converter

- Wide input range 85-264VAC
- Standby mode optimized PSU (ENER Lot 6)
- Ultra-high efficiency over entire load range
- Operating temperature range: -40°C to +85°C
- Class II installations (without FG)
- EMC compliant without external components
- No load power consumption 40mW typ.

RECOM

AC/DC Converter

RAC20-K

20 Watt
2" x 1"
Single and Dual Output

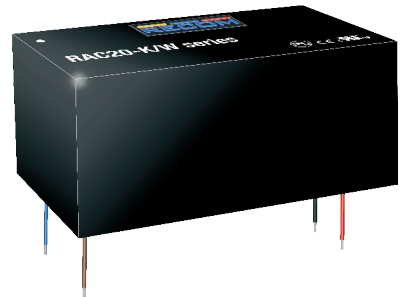

IEC/EN62368-1 certified
UL62368-1 certified
CAN/CSA-C22.2 No. 62368-1-14 certified
IEC/EN60335 certified
IEC/EN61558-1 certified
IEC/EN61558-2-16 certified
IEC/EN61204-3 compliant
EN55032/14 compliant
EN55024 compliant
CB Report

Description

The RAC20-K series are highly efficient PCB-mount power conversion modules with ultra-low energy losses especially in light load conditions, making them a benchmark for always-on and standby mode operations, which are typically coming along with IoT and smart applications. The power supply units cover worldwide mains input range of 85VAC up to 264VAC and come with international safety certifications for industrial, AV and ITE as well as household standards. These AC/DC modules operate in a temperature range of -40°C to +85°C and offer fully protected single or dual outputs as well as EMC class B compliance without the need of any external components.

Selection Guide

Part Number	Input Voltage Range [VAC]	Output Voltage [VDC]	Output Current [mA]	Efficiency typ ⁽¹⁾ [%]	Max. Capacitive Load ⁽²⁾ [µF]
RAC20-05SK ⁽³⁾	85-264	5	4000	84	10000
RAC20-12SK ⁽³⁾	85-264	12	1670	86	8000
RAC20-15SK ⁽³⁾	85-264	15	1333	86	1500
RAC20-24SK ⁽³⁾	85-264	24	840	85	1000
RAC20-48SK ⁽³⁾	85-264	48	420	85	330
RAC20-12DK	85-264	±12	±833	84	±1200
RAC20-15DK	85-264	±15	±670	84	±1000

Notes:

Note1: Efficiency is tested at 230VAC input and constant resistive load at +25°C ambient

Note2: Max Cap Load is tested at nominal input and full resistive load

Model Numbering



Notes:

Note3: Add suffix „W“ for wired version (only single output) without suffix, standard pin version

Ordering Examples:

RAC20-05SK	5Watt	5Vout	Single Output	standard pin version
RAC20-05SK/W	5Watt	5Vout	Single Output	wired version
RAC20-12DK	5Watt	12Vout	Dual Output	standard pin version

Specifications (measured @ Ta= 25°C, nom. Vin, full load and after warm-up unless otherwise stated)

BASIC CHARACTERISTICS					
Parameter	Condition		Min.	Typ.	Max.
Internal Input Filter			Pi type		
Input Voltage Range ^(4,5)	nom. Vin= 230VAC		85VAC 120VDC	230VAC	264VAC 370VDC
Input Current	115VAC 230VAC				450mA 400mA
Inrush Current	cold start at +25°C	115VAC 230VAC			20A 40A
No Load Power Consumption	230VAC			40mW	
ErP Lot 6 Standby Mode Conformity (Output Load Capability)	0.5W Input Power = 1.0W 2.0W				0.3W 0.7W 1.6W
Input Frequency Range	AC Input		47Hz		63Hz
Minimum Load ⁽⁷⁾	single dual (required for regulation on both outputs)		0%	10%	
Power Factor	115VAC 230VAC		0.6 0.5		
Start-up Time				150ms	
Rise Time				40ms	
Hold-up Time	115VAC 230VAC			15ms 90ms	
Internal Operating Frequency					100kHz
Output Ripple and Noise ⁽⁶⁾	20MHz BW			100mVp-p	

Notes:

Note4: The products were submitted for safety files at AC-Input operation

Note5: Refer to "Line Derating"

Note6: Measurements are made with a 1.0µF MLCC across output (low ESR)

Efficiency vs. Load

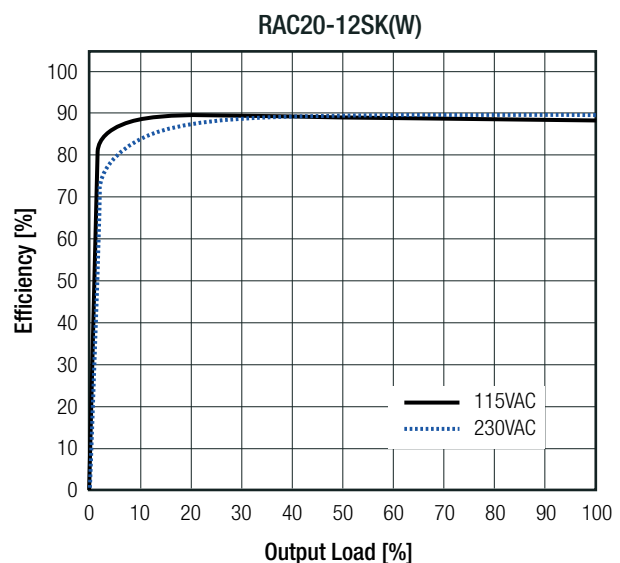
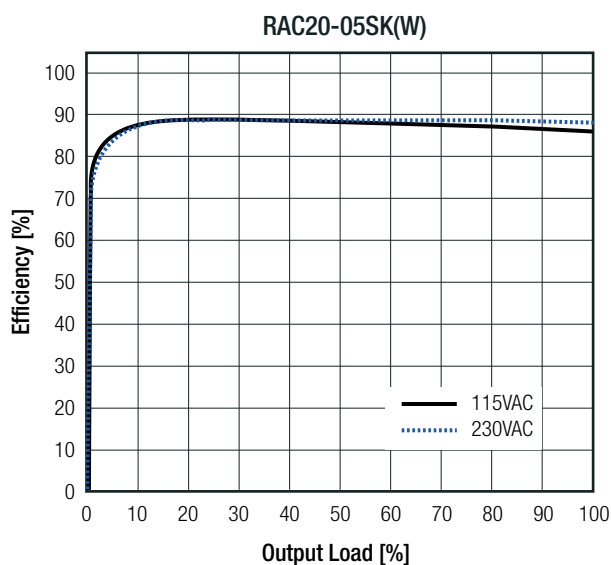

continued on next page

Specifications (measured @ Ta= 25°C, nom. Vin, full load and after warm-up unless otherwise stated)

Efficiency vs. Load



REGULATIONS

Parameter	Condition	Value
Output Accuracy		±2.0% typ.
Line Regulation	low line to high line	±0.5% typ.
Load Regulation ⁽⁷⁾	10% to 100% load	±2.0% typ.
Cross Regulation	dual output only	±10.0% typ.
Transient Response	25% load step change recovery time	4.0% max. 500µs typ.

Notes:

Note7: Operation below 10% load will not harm the converter, but specifications may not be met

Deviation vs. Load

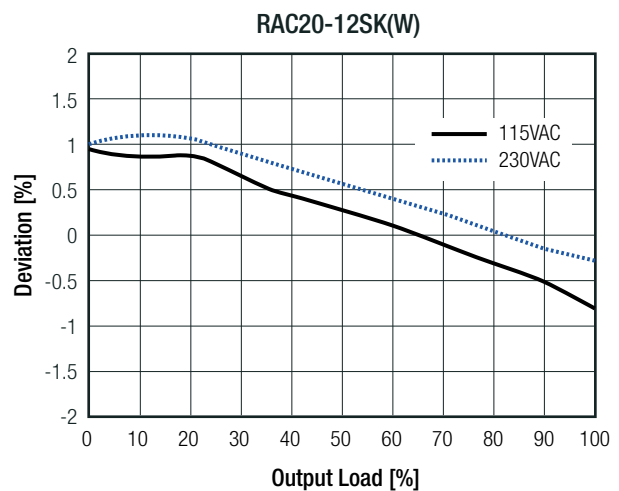
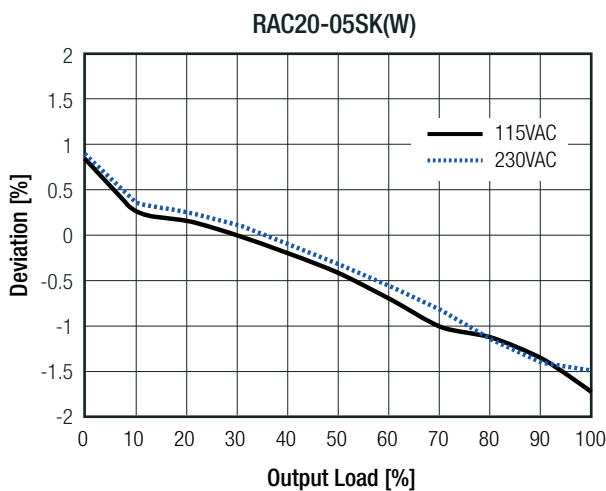

continued on next page

Specifications (measured @ Ta= 25°C, nom. Vin, full load and after warm-up unless otherwise stated)

Deviation vs. Load



PROTECTIONS

Parameter	Type	Value
Input Fuse ⁽⁸⁾	internal	T3.15A, slow blow type
Short Circuit Protection (SCP)	below 100mΩ	hiccup, auto recovery
Over Voltage Protection (OVP)		150% - 195%, latch off mode
Over Current Protection (OCP)		110% - 130%, hiccup mode
Over Voltage Category		OVCII
Class of Equipment		Class II
Isolation Voltage ⁽⁹⁾	I/P to O/P	tested for 1 minute
Isolation Resistance		V _{iso} = 500VDC
Isolation Capacitance		100pF max.
Insulation Grade		reinforced
Leakage Current		0.25mA max.

Notes:

Note8: Refer to local safety regulations if input over-current protection is also required

Note9: For repeat Hi-Pot testing, reduce the time and/or the test voltage

ENVIRONMENTAL

Parameter	Condition	Value
Operating Temperature Range	@ natural convection 0.1m/s	full load: -40°C to +55°C
		refer to derating graph: -40°C to +85°C
Maximum Case Temperature		+95°C
Temperature Coefficient		0.05%/K
Operating Altitude		3000m
Operating Humidity	non-condensing	20% - 90% RH max.
IP Rating		IP20
Pollution Degree		PD2
Vibration	according to MIL-STD-202G	10-500Hz, 2G 10min./1cycle, period 60min. along x,y,z axes
Design Lifetime	+25°C	130 x 10 ³ hours
	+55°C	16 x 10 ³ hours
MTBF	according to MIL-HDBK-217F, G.B.	+25°C
		+55°C

continued on next page

Specifications (measured @ Ta= 25°C, nom. Vin, full load and after warm-up unless otherwise stated)

Derating Graph

(@ Chamber and natural convection 0.1 m/s)

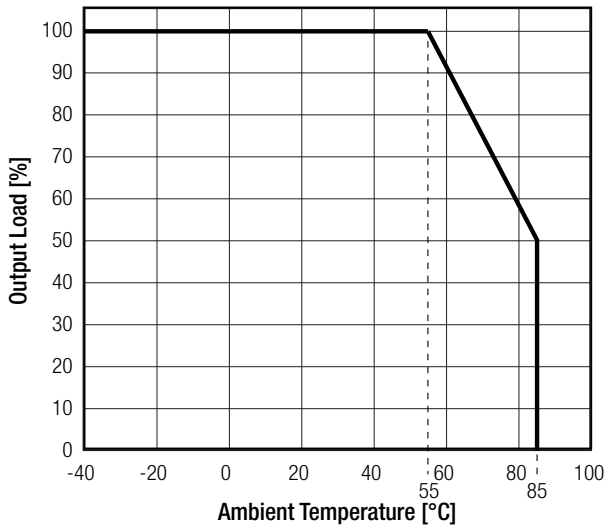

Line Derating



SAFETY AND CERTIFICATIONS

Certificate Type (Safety)	Report / File Number	Standard
Audio/Video, information and communication technology equipment - Safety requirements	E224736	UL62368-1, 2nd Edition, 2014 CAN/CSA C22.2 Nr. 62368-1-14, 2nd Ed. 2014
Audio/Video, information and communication technology equipment - Safety requirements (CB Scheme)	E491408-A6008-CB-1	IEC62368-1:2014 2nd Edition
Audio/Video, information and communication technology equipment - Safety requirements (LVD)		EN62368-1:2014 + A11:2017
Household and similar electrical appliances – Safety – Part 1: General requirements	LCS180508046AS	IEC60335-1:2010 + AMD2:2016 + COR1:2016 EN60335-1:2012 + A11:2014 + A13:2017
Safety of power transformers, power supplies, reactors and similar products for supply voltages up to 1100 V (CB Scheme)	50198090 001	IEC61558-1:2005 2nd Edition + A1:2009
Safety of power transformers, power supplies, reactors and similar products for supply voltages up to 1100 V		EN61558-1:2005 + A1:2009
Safety of power transformers, power supplies, reactors and similar products for supply voltages up to 1100 V Part 2: Particular requirements (CB Scheme)	50198090 001	IEC61558-2-16:2009 1st Edition + A1:2013
Safety of power transformers, power supplies, reactors and similar products for supply voltages up to 1100 V Part 2: Particular requirements		EN61558-2-16:2009 + A1:2013
RoHS2+		RoHS-2011/65/EU + AM-2015/863

EMC Compliance	Condition	Standard / Criterion
Low voltage power supplies, d.c. output Part 3: Electromagnetic compatibility (EMC)		IEC/EN61204-3:2018, Class B
Electromagnetic compatibility of multimedia equipment - Emission requirements	without external filter	EN55032:2015, Class B
Electromagnetic compatibility of household appliances, electric tools and similar apparatus - Emission Requirements		EN55014-1:2006 + A2:2011
Information technology equipment - Immunity characters - Limits and methods of measurement		EN55024:2010 + A1:2015
Electromagnetic compatibility of household appliances, electric tools and similar apparatus - Immunity Requirements		EN55014-2:2015
ESD Electrostatic discharge immunity test	Air ±8kV, Contact ±4kV	EN61000-4-2:2009, Criteria B
Radiated, radio-frequency, electromagnetic field immunity test	80MHz - 6GHz: 10V/m 1.4GHz - 2GHz: 3V/m 2.0GHz - 2.7GHz: 1V/m	EN61000-4-3:2006 + A1:2008, Criteria A
Fast Transient and Burst Immunity	AC Port: ±2.0kV DC Port: ±2.0kV	EN61000-4-4:2012, Criteria B

continued on next page

Specifications (measured @ Ta= 25°C, nom. Vin, full load and after warm-up unless otherwise stated)

EMC Compliance	Condition	Standard / Criterion
Surge Immunity	AC Port: L-N ±1.0kV DC Port: ±0.5kV	EN61000-4-5:2014 + A1:2017, Criteria B
Immunity to conducted disturbances, induced by radio-frequency fields	AC Port: 10V DC Port: 10V	EN61000-4-6:2014, Criteria A
Power Magnetic Field Immunity	50Hz, 30A/m	EN61000-4-8:2010, Criteria A
Voltage Dips and Interruptions	Voltage Dips 20% Voltage Dips 30% Voltage Dips 60% Voltage Dips 100% Voltage Interruptions > 95%	EN61000-4-11:2004 + A1:2017, Criteria C EN61000-4-11:2004 + A1:2017, Criteria C EN61000-4-11:2004 + A1:2017, Criteria C EN61000-4-11:2004 + A1:2017, Criteria B EN61000-4-11:2004 + A1:2017, Criteria C
Limits of Voltage Fluctuations & Flicker		EN61000-3-3:2013
Limitations on the amount of electromagnetic interference allowed from digital and electronic devices		FCC 47 CFR Part 15 Subpart B, Class B
American National Standard for Methods of Measurement of Radio-Noise Emissions from Low-Voltage Electrical and Electronic Equipment in the Range of 9 kHz to 40 GHz		ANSI C63.4-2014, Class B
Notes: Note9: If output is connected to GND, please contact RECOM tech support for advice		

DIMENSION AND PHYSICAL CHARACTERISTICS

Parameter	Type	Value
Material	case potting PCB baseplate	black plastic, (UL94V-0) silicone, (UL94V-0) FR4, (UL94V-0) black plastic, (UL94V-0)
Dimension (LxWxH)		52.5 x 27.4 x 23.0mm
Weight	pin wired	60g typ. 65g typ.

Dimension Drawing (mm)

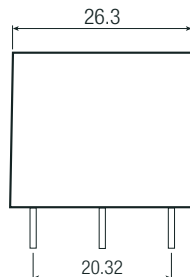
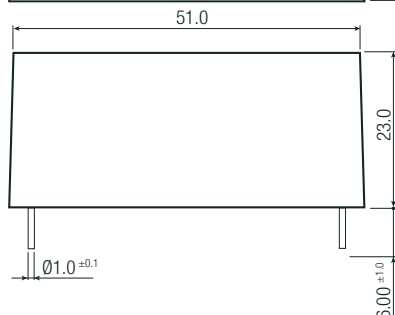
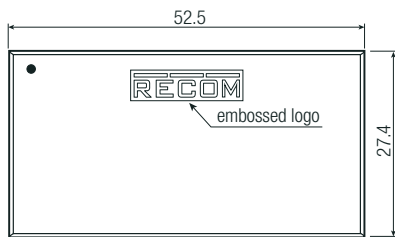
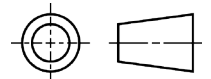

Pinning information

Pin #	Single	Dual
1	VAC in (N)	VAC in (N)
2	VAC in (L)	VAC in (L)
3	no pin	-Vout
4	-Vout	Com
5	+Vout	+Vout

Tolerance: xx.x= ±0.5mm
xx.xx= ±0.25mm

Recommended Footprint Details

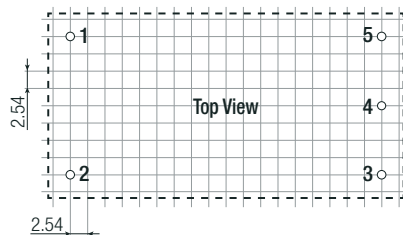
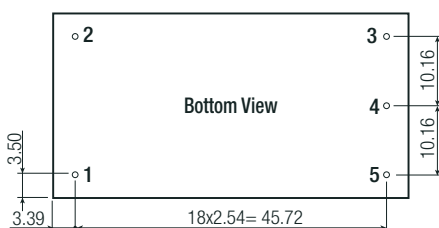

continued on next page

Specifications (measured @ Ta= 25°C, nom. Vin, full load and after warm-up unless otherwise stated)

Dimension Drawing Single Wired (mm)

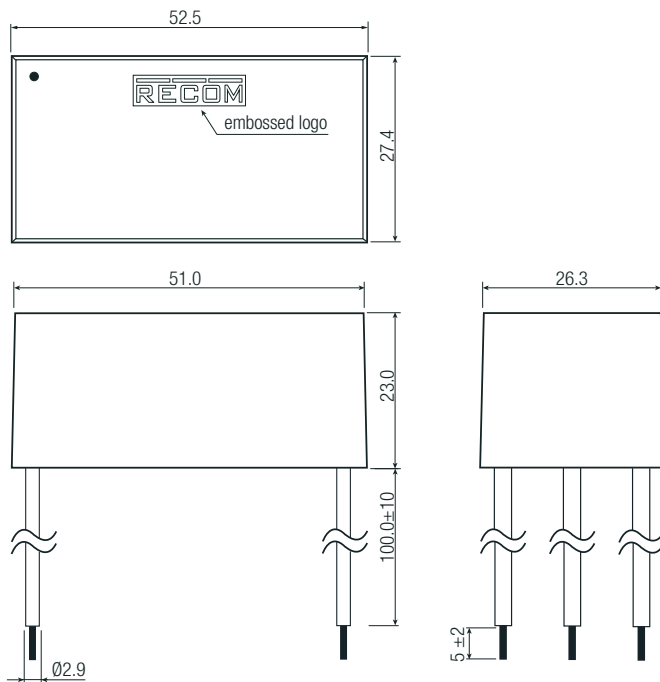
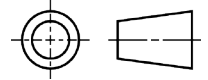

Wired information

#	Function	Wire color	Type	AWG
1	VAC in (N)	blue	UL-1015	18
2	VAC in (L)	brown	UL-1015	18
4	-Vout	black	UL-1015	18
5	+Vout	red	UL-1015	18

Tolerance: xx.x= ±0.5mm
xx.xx= ±0.25mm

PACKAGING INFORMATION

Parameter	Type		Value
	pin wired	tube tray	
Packaging Dimension (LxWxH)			490.0 x 56.0 x 40.0mm
			488.0 x 202.0 x 47.0mm
Packaging Quantity		tube tray	15pcs
		tray	20pcs
Storage Temperature Range			-40°C to +85°C
Storage Humidity		non-condensing	20% to 90% RH max.

The product information and specifications may be subject to changes even without prior written notice. The product has been designed for various applications; its suitability lies in the responsibility of each customer. The products are not authorized for use in safety-critical applications without RECOM's explicit written consent. A safety-critical application is an application where a failure may reasonably be expected to endanger or cause loss of life, inflict bodily harm or damage property. The applicant shall indemnify and hold harmless RECOM, its affiliated companies and its representatives against any damage claims in connection with the unauthorized use of RECOM products in such safety-critical applications.

Компания «Life Electronics» занимается поставками электронных компонентов импортного и отечественного производства от производителей и со складов крупных дистрибьюторов Европы, Америки и Азии.

С конца 2013 года компания активно расширяет линейку поставок компонентов по направлению коаксиальный кабель, кварцевые генераторы и конденсаторы (керамические, пленочные, электролитические), за счёт заключения дистрибьюторских договоров

Мы предлагаем:

- Конкуренспособные цены и скидки постоянным клиентам.
- Специальные условия для постоянных клиентов.
- Подбор аналогов.
- Поставку компонентов в любых объемах, удовлетворяющих вашим потребностям.
- Приемлемые сроки поставки, возможна ускоренная поставка.
- Доставку товара в любую точку России и стран СНГ.
- Комплексную поставку.
- Работу по проектам и поставку образцов.
- Формирование склада под заказчика.
- Сертификаты соответствия на поставляемую продукцию (по желанию клиента).
- Тестирование поставляемой продукции.
- Поставку компонентов, требующих военную и космическую приемку.
- Входной контроль качества.
- Наличие сертификата ISO.

В составе нашей компании организован Конструкторский отдел, призванный помогать разработчикам, и инженерам.

Конструкторский отдел помогает осуществить:

- Регистрацию проекта у производителя компонентов.
- Техническую поддержку проекта.
- Защиту от снятия компонента с производства.
- Оценку стоимости проекта по компонентам.
- Изготовление тестовой платы монтаж и пусконаладочные работы.



Тел: +7 (812) 336 43 04 (многоканальный)

Email: org@lifeelectronics.ru