

MC74AC74, MC74ACT74

Dual D-Type Positive Edge-Triggered Flip-Flop

The MC74AC74/74ACT74 is a dual D-type flip-flop with Asynchronous Clear and Set inputs and complementary (Q, \bar{Q}) outputs. Information at the input is transferred to the outputs on the positive edge of the clock pulse. Clock triggering occurs at a voltage level of the clock pulse and is not directly related to the transition time of the positive-going pulse. After the Clock Pulse input threshold voltage has been passed, the Data input is locked out and information present will not be transferred to the outputs until the next rising edge of the Clock Pulse input.

Asynchronous Inputs:

LOW input to \bar{S}_D (Set) sets Q to HIGH level

LOW input to \bar{C}_D (Clear) sets Q to LOW level

Clear and Set are independent of clock

Simultaneous LOW on \bar{C}_D and \bar{S}_D makes both Q and \bar{Q} HIGH

Features

- Outputs Source/Sink 24 mA
- 'ACT74 Has TTL Compatible Inputs
- Pb-Free Packages are Available

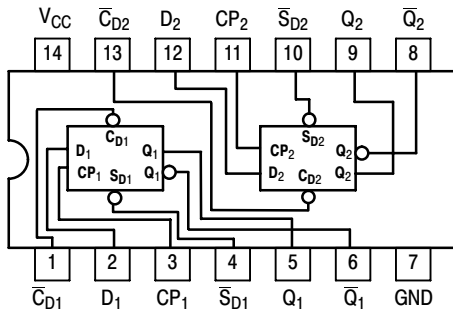

Figure 1. Pinout: 14-Lead Packages Conductors (Top View)

PIN ASSIGNMENT

PIN	FUNCTION
D_1, D_2	Data Inputs
CP_1, CP_2	Clock Pulse Inputs
$\bar{C}_{D1}, \bar{C}_{D2}$	Direct Clear Inputs
$\bar{S}_{D1}, \bar{S}_{D2}$	Direct Set Inputs
$Q_1, \bar{Q}_1, Q_2, \bar{Q}_2$	Outputs



ON Semiconductor®

<http://onsemi.com>

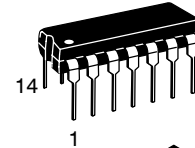

PDIP-14
N SUFFIX
CASE 646

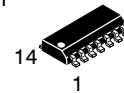

SOIC-14
D SUFFIX
CASE 751A

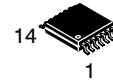

TSSOP-14
DT SUFFIX
CASE 948G

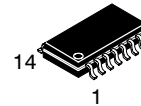



SOEIAJ-14
M SUFFIX
CASE 965

ORDERING INFORMATION

See detailed ordering and shipping information in the package dimensions section on page 7 of this data sheet.

MC74AC74, MC74ACT74

TRUTH TABLE (Each Half)

Inputs				Outputs	
\bar{S}_D	\bar{C}_D	CP	D	Q	\bar{Q}
L	H	X	X	H	L
H	L	X	X	L	H
L	L	X	X	H	H
H	H		H	H	L
H	H		L	L	H
H	H	L	X	Q_0	\bar{Q}_0

NOTE: H = HIGH Voltage Level
 L = LOW Voltage Level
 X = Immaterial;
 = LOW-to-HIGH Clock Transition
 $Q_0(\bar{Q}_0)$ = Previous $Q(\bar{Q})$ before LOW-to-HIGH Transition of Clock

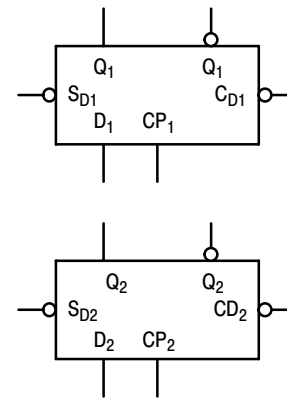
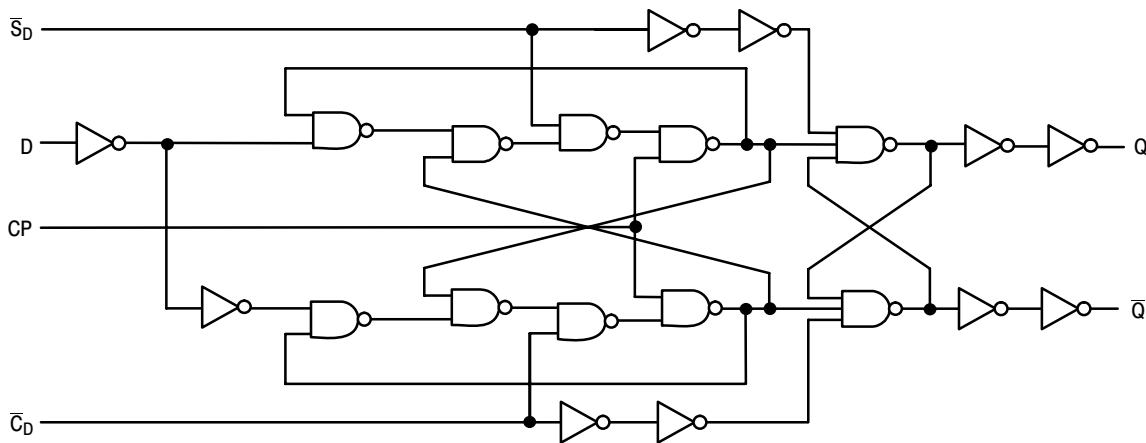

Figure 2. Logic Symbol



NOTE: This diagram is provided only for the understanding of logic operations and should not be used to estimate propagation delays.

Figure 3. Logic Diagram

MAXIMUM RATINGS

Symbol	Parameter	Value	Unit
V_{CC}	DC Supply Voltage (Referenced to GND)	-0.5 to +7.0	V
V_{in}	DC Input Voltage (Referenced to GND)	-0.5 to $V_{CC} + 0.5$	V
V_{out}	DC Output Voltage (Referenced to GND)	-0.5 to $V_{CC} + 0.5$	V
I_{in}	DC Input Current, per Pin	± 20	mA
I_{out}	DC Output Sink/Source Current, per Pin	± 50	mA
I_{CC}	DC V_{CC} or GND Current per Output Pin	± 50	mA
T_{stg}	Storage Temperature	-65 to +150	$^{\circ}C$

Stresses exceeding Maximum Ratings may damage the device. Maximum Ratings are stress ratings only. Functional operation above the Recommended Operating Conditions is not implied. Extended exposure to stresses above the Recommended Operating Conditions may affect device reliability.

MC74AC74, MC74ACT74

RECOMMENDED OPERATING CONDITIONS

Symbol	Parameter	Min	Typ	Max	Unit	
V _{CC}	Supply Voltage	'AC	2.0	5.0	6.0	V
		'ACT	4.5	5.0	5.5	
V _{in} , V _{out}	DC Input Voltage, Output Voltage (Ref. to GND)	0	–	V _{CC}	V	
t _r , t _f	Input Rise and Fall Time (Note) 'AC Devices except Schmitt Inputs	V _{CC} @ 3.0 V	–	150	–	ns/V
		V _{CC} @ 4.5 V	–	40	–	
		V _{CC} @ 5.5 V	–	25	–	
t _r , t _f	Input Rise and Fall Time (Note) 'ACT Devices except Schmitt Inputs	V _{CC} @ 4.5 V	–	10	–	ns/V
		V _{CC} @ 5.5 V	–	8.0	–	
T _J	Junction Temperature (PDIP)	–	–	140	°C	
T _A	Operating Ambient Temperature Range	–40	25	85	°C	
I _{OH}	Output Current – High	–	–	–24	mA	
I _{OL}	Output Current – Low	–	–	24	mA	

- V_{in} from 30% to 70% V_{CC}; see individual Data Sheets for devices that differ from the typical input rise and fall times.
- V_{in} from 0.8 V to 2.0 V; see individual Data Sheets for devices that differ from the typical input rise and fall times.

DC CHARACTERISTICS

Symbol	Parameter	V _{CC} (V)	74AC		74ACT	Unit	Conditions			
			T _A = +25°C		T _A = –40°C to +85°C					
			Typ	Guaranteed Limits						
V _{IH}	Minimum High Level Input Voltage	3.0	1.5	2.1	2.1	V	V _{OUT} = 0.1 V or V _{CC} – 0.1 V			
		4.5	2.25	3.15	3.15					
		5.5	2.75	3.85	3.85					
V _{IL}	Maximum Low Level Input Voltage	3.0	1.5	0.9	0.9	V	V _{OUT} = 0.1 V or V _{CC} – 0.1 V			
		4.5	2.25	1.35	1.35					
		5.5	2.75	1.65	1.65					
V _{OH}	Minimum High Level Output Voltage	3.0	2.99	2.9	2.9	V	I _{OUT} = –50 μA			
		4.5	4.49	4.4	4.4					
		5.5	5.49	5.4	5.4					
	3.0	–	2.56	2.46	V	*V _{IN} = V _{IL} or V _{IH} –12 mA I _{OH} –24 mA –24 mA				
							4.5	–	3.86	3.76
							5.5	–	4.86	4.76
V _{OL}	Maximum Low Level Output Voltage	3.0	0.002	0.1	0.1	V	I _{OUT} = 50 μA			
		4.5	0.001	0.1	0.1					
		5.5	0.001	0.1	0.1					
	3.0	–	0.36	0.44	V	*V _{IN} = V _{IL} or V _{IH} 12 mA I _{OL} 24 mA 24 mA				
							4.5	–	0.36	0.44
							5.5	–	0.36	0.44
I _{IN}	Maximum Input Leakage Current	5.5	–	±0.1	±1.0	μA	V _I = V _{CC} , GND			
I _{OLD}	†Minimum Dynamic Output Current	5.5	–	–	75	mA	V _{OLD} = 1.65 V Max			
I _{OHD}		5.5	–	–	–75	mA	V _{OHD} = 3.85 V Min			
I _{CC}	Maximum Quiescent Supply Current	5.5	–	4.0	40	μA	V _{IN} = V _{CC} or GND			

*All outputs loaded; thresholds on input associated with output under test.

†Maximum test duration 2.0 ms, one output loaded at a time.

NOTE: I_{IN} and I_{CC} @ 3.0 V are guaranteed to be less than or equal to the respective limit @ 5.5 V V_{CC}.

MC74AC74, MC74ACT74

AC CHARACTERISTICS (For Figures and Waveforms – See Section 3 of the ON Semiconductor FACT Data Book, DL138/D)

Symbol	Parameter	V _{CC} * (V)	74AC			74AC		Unit	Fig. No.
			T _A = +25°C C _L = 50 pF			T _A = -40°C to +85°C C _L = 50 pF			
			Min	Typ	Max	Min	Max		
f _{max}	Maximum Clock Frequency	3.3 5.0	100 140	125 160	– –	95 125	– –	MHz	3–3
t _{PLH}	Propagation Delay C _{Dn} or S _{Dn} to Q _n or Q _n	3.3 5.0	5.0 3.5	8.0 6.0	12.5 9.0	4.0 3.0	13.0 10.0	ns	3–6
t _{PHL}	Propagation Delay C _{Dn} or S _{Dn} to Q _n or Q _n	3.3 5.0	4.0 3.0	10.5 8.0	12.0 9.5	3.5 2.5	13.5 10.5	ns	3–6
t _{PLH}	Propagation Delay C _{Pn} to Q _n or Q _n	3.3 5.0	4.5 3.5	8.0 6.0	13.5 10.0	4.0 3.0	16.0 10.5	ns	3–6
t _{PHL}	Propagation Delay C _{Pn} to Q _n or Q _n	3.3 5.0	3.5 2.5	8.0 6.0	14.0 10.0	3.5 2.5	14.5 10.5	ns	3–6

*Voltage Range 3.3 V is 3.3 V ±0.3 V.
Voltage Range 5.0 V is 5.0 V ±0.5 V.

AC OPERATING REQUIREMENTS

Symbol	Parameter	V _{CC} * (V)	74AC		74AC		Unit	Fig. No.
			T _A = +25°C C _L = 50 pF		T _A = -40°C to +85°C C _L = 50 pF			
			Typ	Guaranteed Minimum				
t _s	Set-up Time, HIGH or LOW D _n to CP _n	3.3 5.0	1.5 1.0	4.0 3.0	4.5 3.0	ns	3–9	
t _h	Hold Time, HIGH or LOW D _n to CP _n	3.3 5.0	-2.0 -1.5	0.5 0.5	0.5 0.5	ns	3–9	
t _w	C _{Pn} or C _{Dn} or S _{Dn} Pulse Width	3.3 5.0	3.0 2.5	5.5 4.5	7.0 5.0	ns	3–6	
t _{rec}	Recovery Time C _{Dn} or S _{Dn} to CP	3.3 5.0	-2.5 -2.0	0 0	0 0	ns	3–9	

*Voltage Range 3.3 V is 3.3 V ±0.3 V.
Voltage Range 5.0 V is 5.0 V ±0.5 V.

MC74AC74, MC74ACT74

DC CHARACTERISTICS

Symbol	Parameter	V _{CC} (V)	74ACT		74ACT		Unit	Conditions
			T _A = +25°C		T _A = -40°C to +85°C			
			Typ	Guaranteed Limits				
V _{IH}	Minimum High Level Input Voltage	4.5	1.5	2.0	2.0	V	V _{OUT} = 0.1 V or V _{CC} - 0.1 V	
		5.5	1.5	2.0	2.0			
V _{IL}	Maximum Low Level Input Voltage	4.5	1.5	0.8	0.8	V	V _{OUT} = 0.1 V or V _{CC} - 0.1 V	
		5.5	1.5	0.8	0.8			
V _{OH}	Minimum High Level Output Voltage	4.5	4.49	4.4	4.4	V	I _{OUT} = -50 μA	
		5.5	5.49	5.4	5.4			
		4.5	-	3.86	3.76	V	*V _{IN} = V _{IL} or V _{IH} -24 mA	
		5.5	-	4.86	4.76			
V _{OL}	Maximum Low Level Output Voltage	4.5	0.001	0.1	0.1	V	I _{OUT} = 50 μA	
		5.5	0.001	0.1	0.1			
		4.5	-	0.36	0.44	V	*V _{IN} = V _{IL} or V _{IH} 24 mA	
		5.5	-	0.36	0.44			
I _{IN}	Maximum Input Leakage Current	5.5	-	±0.1	±1.0	μA	V _I = V _{CC} , GND	
ΔI _{CCT}	Additional Max. I _{CC} /Input	5.5	0.6	-	1.5	mA	V _I = V _{CC} - 2.1 V	
I _{OLD}	†Minimum Dynamic Output Current	5.5	-	-	75	mA	V _{OLD} = 1.65 V Max	
I _{OHD}		5.5	-	-	-75	mA	V _{OHD} = 3.85 V Min	
I _{CC}	Maximum Quiescent Supply Current	5.5	-	4.0	40	μA	V _{IN} = V _{CC} or GND	

*All outputs loaded; thresholds on input associated with output under test.

†Maximum test duration 2.0 ms, one output loaded at a time.

AC CHARACTERISTICS (For Figures and Waveforms – See Section 3 of the ON Semiconductor FACT Data Book, DL138/D)

Symbol	Parameter	V _{CC} * (V)	74ACT			74ACT		Unit	Fig. No.
			T _A = +25°C C _L = 50 pF			T _A = -40°C to +85°C C _L = 50 pF			
			Min	Typ	Max	Min	Max		
f _{max}	Maximum Clock Frequency	5.0	145	210	-	125	-	MHz	3-3
t _{PLH}	Propagation Delay C _{Dn} or S _{Dn} to Q _n or Q _n	5.0	3.0	5.5	9.5	2.5	10.5	ns	3-6
t _{PHL}	Propagation Delay C _{Dn} or S _{Dn} to Q _n or Q _n	5.0	3.0	6.0	10.0	3.0	11.5	ns	3-6
t _{PLH}	Propagation Delay C _{Pn} to Q _n or Q _n	5.0	4.0	7.5	11.0	4.0	13.0	ns	3-6
t _{PHL}	Propagation Delay C _{Pn} to Q _n or Q _n	5.0	3.5	6.0	10.0	3.0	11.5	ns	3-6

*Voltage Range 5.0 V is 5.0 V ±0.5 V.

MC74AC74, MC74ACT74

AC OPERATING REQUIREMENTS

Symbol	Parameter	V _{CC} * (V)	74ACT		74ACT	Unit	Fig. No.
			T _A = +25°C C _L = 50 pF		T _A = -40°C to +85°C C _L = 50 pF		
			Typ	Guaranteed Minimum			
t _s	Set-up Time, HIGH or LOW D _n to CP _n	5.0	1.0	3.0	3.5	ns	3-9
t _h	Hold Time, HIGH or LOW D _n to CP _n	5.0	-0.5	1.0	1.0	ns	3-9
t _w	C _{Pn} or \overline{C}_{Dn} or \overline{S}_{Dn} Pulse Width	5.0	3.0	5.0	6.0	ns	3-6
t _{rec}	Recovery Time \overline{C}_{Dn} or \overline{S}_{Dn} to CP	5.0	-2.5	0	0	ns	3-9

*Voltage Range 5.0 V is 5.0 V ±0.5 V.

CAPACITANCE

Symbol	Parameter	Value Typ	Unit	Test Conditions
C _{IN}	Input Capacitance	4.5	pF	V _{CC} = 5.0 V
C _{PD}	Power Dissipation Capacitance	35	pF	V _{CC} = 5.0 V

MC74AC74, MC74ACT74

ORDERING INFORMATION

Device	Package	Shipping†
MC74AC74N	PDIP-14	25 Units/Rail
MC74AC74NG	PDIP-14 (Pb-Free)	
MC74ACT74N	PDIP-14	
MC74ACT74NG	PDIP-14 (Pb-Free)	
MC74AC74D	SOIC-14	55 Units/Rail
MC74AC74DG	SOIC-14 (Pb-Free)	
MC74AC74DR2	SOIC-14	2500/Tape & Reel
MC74AC74DR2G	SOIC-14 (Pb-Free)	
MC74ACT74D	SOIC-14	55 Units/Rail
MC74ACT74DG	SOIC-14 (Pb-Free)	
MC74ACT74DR2	SOIC-14	2500/Tape & Reel
MC74ACT74DR2G	SOIC-14 (Pb-Free)	
MC74AC74DT	TSSOP-14*	96 Units/Rail
MC74AC74DTR2	TSSOP-14*	2500/Tape & Reel
MC74AC74DTR2G	TSSOP-14*	
MC74ACT74DT	TSSOP-14*	96 Units/Rail
MC74ACT74DTR2	TSSOP-14*	2500/Tape & Reel
MC74ACT74DTR2G	TSSOP-14*	
MC74AC74MEL	SOEIAJ-14	2000/Tape & Reel
MC74AC74MELG	SOEIAJ-14 (Pb-Free)	
MC74ACT74MEL	SOEIAJ-14	
MC74ACT74MELG	SOEIAJ-14 (Pb-Free)	

†For information on tape and reel specifications, including part orientation and tape sizes, please refer to our Tape and Reel Packaging Specifications Brochure, BRD8011/D.

*This package is inherently Pb-Free.

MC74AC74, MC74ACT74

MARKING DIAGRAMS

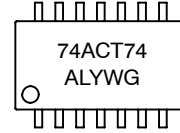
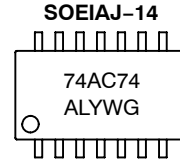
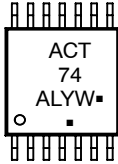
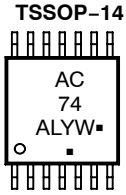
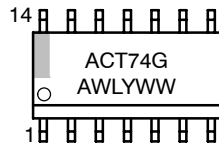
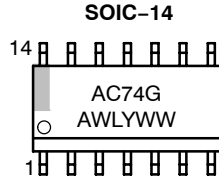
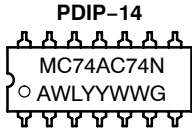

A = Assembly Location
WL, L = Wafer Lot
YY, Y = Year
WW, W = Work Week
G or ▪ = Pb-Free Package
(Note: Microdot may be in either location)

MC74AC74, MC74ACT74

PACKAGE DIMENSIONS

PDIP-14
CASE 646-06
ISSUE P

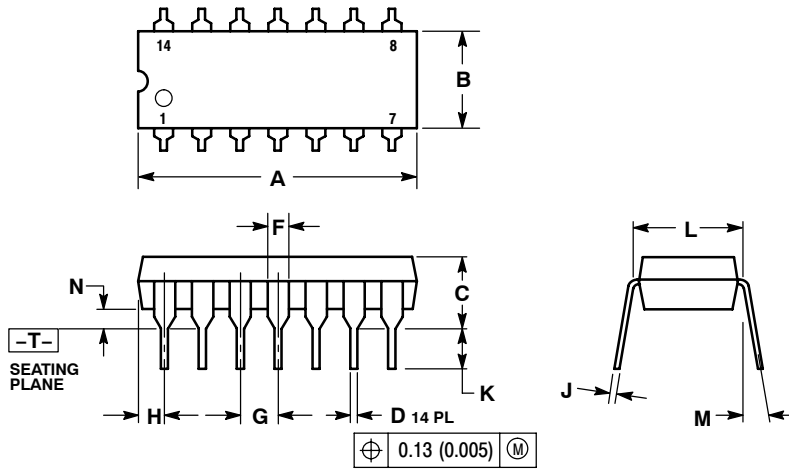

NOTES:

1. DIMENSIONING AND TOLERANCING PER ANSI Y14.5M, 1982.
2. CONTROLLING DIMENSION: INCH.
3. DIMENSION L TO CENTER OF LEADS WHEN FORMED PARALLEL.
4. DIMENSION B DOES NOT INCLUDE MOLD FLASH.
5. ROUNDED CORNERS OPTIONAL.

DIM	INCHES		MILLIMETERS	
	MIN	MAX	MIN	MAX
A	0.715	0.770	18.16	19.56
B	0.240	0.260	6.10	6.60
C	0.145	0.185	3.69	4.69
D	0.015	0.021	0.38	0.53
F	0.040	0.070	1.02	1.78
G	0.100 BSC		2.54 BSC	
H	0.052	0.095	1.32	2.41
J	0.008	0.015	0.20	0.38
K	0.115	0.135	2.92	3.43
L	0.290	0.310	7.37	7.87
M	---	10°	---	10°
N	0.015	0.039	0.38	1.01

MC74AC74, MC74ACT74

SOIC-14
CASE 751A-03
ISSUE H

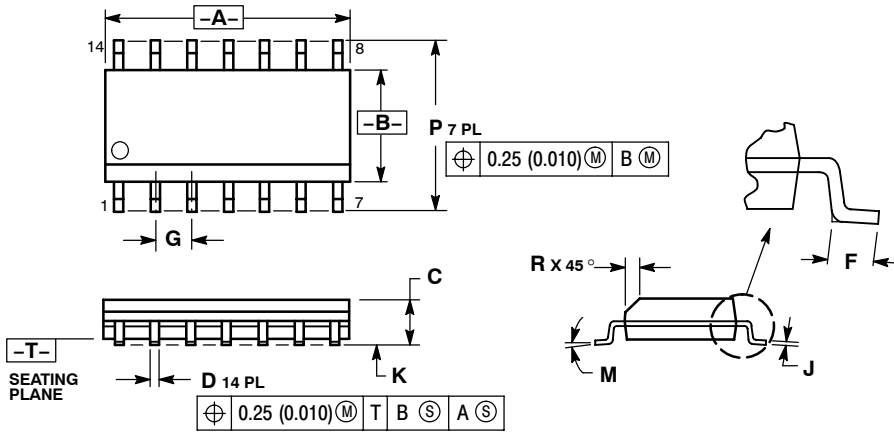

NOTES:

1. DIMENSIONING AND TOLERANCING PER ANSI Y14.5M, 1982.
2. CONTROLLING DIMENSION: MILLIMETER.
3. DIMENSIONS A AND B DO NOT INCLUDE MOLD PROTRUSION.
4. MAXIMUM MOLD PROTRUSION 0.15 (0.006) PER SIDE.
5. DIMENSION D DOES NOT INCLUDE DAMBAR PROTRUSION. ALLOWABLE DAMBAR PROTRUSION SHALL BE 0.127 (0.005) TOTAL IN EXCESS OF THE D DIMENSION AT MAXIMUM MATERIAL CONDITION.

DIM	MILLIMETERS		INCHES	
	MIN	MAX	MIN	MAX
A	8.55	8.75	0.337	0.344
B	3.80	4.00	0.150	0.157
C	1.35	1.75	0.054	0.068
D	0.35	0.49	0.014	0.019
F	0.40	1.25	0.016	0.049
G	1.27 BSC		0.050 BSC	
J	0.19	0.25	0.008	0.009
K	0.10	0.25	0.004	0.009
M	0°	7°	0°	7°
P	5.80	6.20	0.228	0.244
R	0.25	0.50	0.010	0.019

SOLDERING FOOTPRINT*

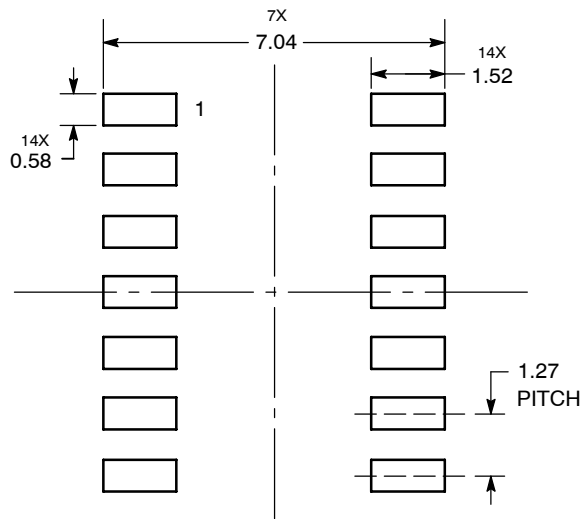

DIMENSIONS: MILLIMETERS

*For additional information on our Pb-Free strategy and soldering details, please download the ON Semiconductor Soldering and Mounting Techniques Reference Manual, SOLDERRM/D.

MC74AC74, MC74ACT74

PACKAGE DIMENSIONS

TSSOP-14
CASE 948G-01
ISSUE B

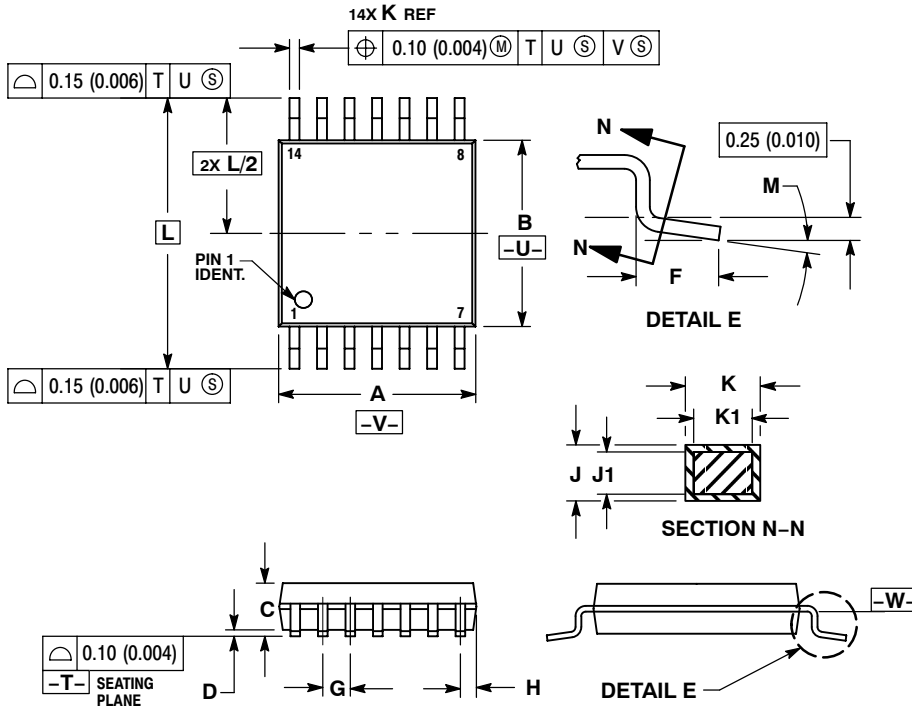

- NOTES:
1. DIMENSIONING AND TOLERANCING PER ANSI Y14.5M, 1982.
 2. CONTROLLING DIMENSION: MILLIMETER.
 3. DIMENSION A DOES NOT INCLUDE MOLD FLASH, PROTRUSIONS OR GATE BURRS. MOLD FLASH OR GATE BURRS SHALL NOT EXCEED 0.15 (0.006) PER SIDE.
 4. DIMENSION B DOES NOT INCLUDE INTERLEAD FLASH OR PROTRUSION. INTERLEAD FLASH OR PROTRUSION SHALL NOT EXCEED 0.25 (0.010) PER SIDE.
 5. DIMENSION K DOES NOT INCLUDE DAMBAR PROTRUSION. ALLOWABLE DAMBAR PROTRUSION SHALL BE 0.08 (0.003) TOTAL IN EXCESS OF THE K DIMENSION AT MAXIMUM MATERIAL CONDITION.
 6. TERMINAL NUMBERS ARE SHOWN FOR REFERENCE ONLY.
 7. DIMENSION A AND B ARE TO BE DETERMINED AT DATUM PLANE -W-.

SOLDERING FOOTPRINT*

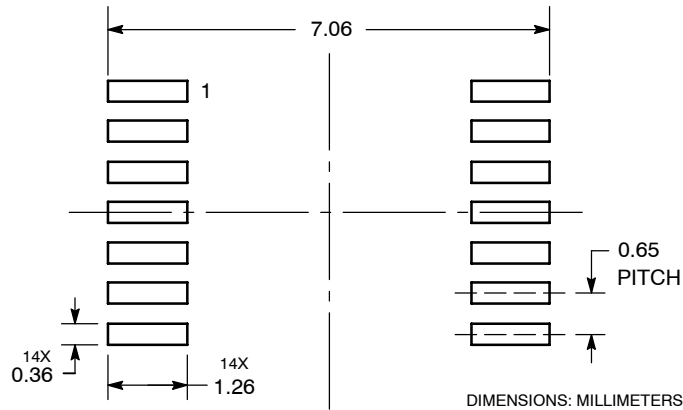

*For additional information on our Pb-Free strategy and soldering details, please download the ON Semiconductor Soldering and Mounting Techniques Reference Manual, SOLDERRM/D.

MC74AC74, MC74ACT74

SOEIAJ-14
CASE 965-01
ISSUE A

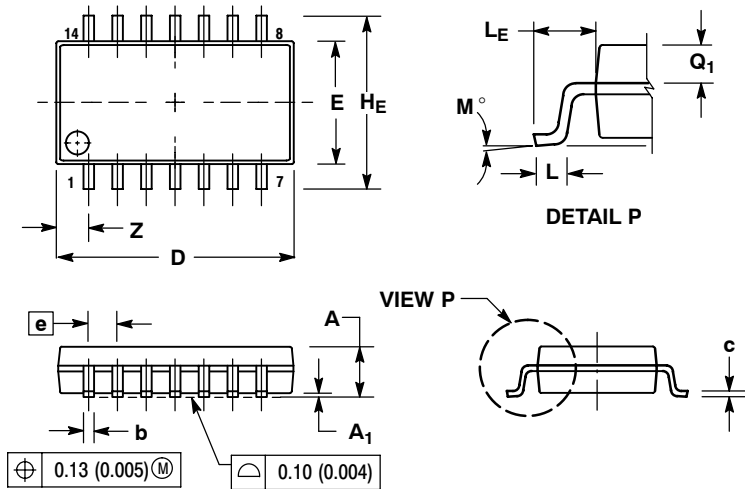

NOTES:

1. DIMENSIONING AND TOLERANCING PER ANSI Y14.5M, 1982.
2. CONTROLLING DIMENSION: MILLIMETER.
3. DIMENSIONS D AND E DO NOT INCLUDE MOLD FLASH OR PROTRUSIONS AND ARE MEASURED AT THE PARTING LINE. MOLD FLASH OR PROTRUSIONS SHALL NOT EXCEED 0.15 (0.006) PER SIDE.
4. TERMINAL NUMBERS ARE SHOWN FOR REFERENCE ONLY.
5. THE LEAD WIDTH DIMENSION (b) DOES NOT INCLUDE DAMBAR PROTRUSION. ALLOWABLE DAMBAR PROTRUSION SHALL BE 0.08 (0.003) TOTAL IN EXCESS OF THE LEAD WIDTH DIMENSION AT MAXIMUM MATERIAL CONDITION. DAMBAR CANNOT BE LOCATED ON THE LOWER RADIUS OR THE FOOT. MINIMUM SPACE BETWEEN PROTRUSIONS AND ADJACENT LEAD TO BE 0.46 (0.018).

DIM	MILLIMETERS		INCHES	
	MIN	MAX	MIN	MAX
A	---	2.05	---	0.081
A ₁	0.05	0.20	0.002	0.008
b	0.35	0.50	0.014	0.020
c	0.10	0.20	0.004	0.008
D	9.90	10.50	0.390	0.413
E	5.10	5.45	0.201	0.215
e	1.27 BSC		0.050 BSC	
H _E	7.40	8.20	0.291	0.323
0.50	0.50	0.85	0.020	0.033
LE	1.10	1.50	0.043	0.059
M	0°	10°	0°	10°
Q ₁	0.70	0.90	0.028	0.035
Z	---	1.42	---	0.056

ON Semiconductor and  are registered trademarks of Semiconductor Components Industries, LLC (SCILLC). SCILLC reserves the right to make changes without further notice to any products herein. SCILLC makes no warranty, representation or guarantee regarding the suitability of its products for any particular purpose, nor does SCILLC assume any liability arising out of the application or use of any product or circuit, and specifically disclaims any and all liability, including without limitation special, consequential or incidental damages. "Typical" parameters which may be provided in SCILLC data sheets and/or specifications can and do vary in different applications and actual performance may vary over time. All operating parameters, including "Typicals" must be validated for each customer application by customer's technical experts. SCILLC does not convey any license under its patent rights nor the rights of others. SCILLC products are not designed, intended, or authorized for use as components in systems intended for surgical implant into the body, or other applications intended to support or sustain life, or for any other application in which the failure of the SCILLC product could create a situation where personal injury or death may occur. Should Buyer purchase or use SCILLC products for any such unintended or unauthorized application, Buyer shall indemnify and hold SCILLC and its officers, employees, subsidiaries, affiliates, and distributors harmless against all claims, costs, damages, and expenses, and reasonable attorney fees arising out of, directly or indirectly, any claim of personal injury or death associated with such unintended or unauthorized use, even if such claim alleges that SCILLC was negligent regarding the design or manufacture of the part. SCILLC is an Equal Opportunity/Affirmative Action Employer. This literature is subject to all applicable copyright laws and is not for resale in any manner.

PUBLICATION ORDERING INFORMATION

LITERATURE FULFILLMENT:

Literature Distribution Center for ON Semiconductor
P.O. Box 5163, Denver, Colorado 80217 USA
Phone: 303-675-2175 or 800-344-3860 Toll Free USA/Canada
Fax: 303-675-2176 or 800-344-3867 Toll Free USA/Canada
Email: orderlit@onsemi.com

N. American Technical Support: 800-282-9855 Toll Free
USA/Canada
Europe, Middle East and Africa Technical Support:
Phone: 421 33 790 2910
Japan Customer Focus Center
Phone: 81-3-5773-3850

ON Semiconductor Website: www.onsemi.com

Order Literature: <http://www.onsemi.com/orderlit>

For additional information, please contact your local Sales Representative

Компания «Life Electronics» занимается поставками электронных компонентов импортного и отечественного производства от производителей и со складов крупных дистрибьюторов Европы, Америки и Азии.

С конца 2013 года компания активно расширяет линейку поставок компонентов по направлению коаксиальный кабель, кварцевые генераторы и конденсаторы (керамические, пленочные, электролитические), за счёт заключения дистрибьюторских договоров

Мы предлагаем:

- Конкурентоспособные цены и скидки постоянным клиентам.
- Специальные условия для постоянных клиентов.
- Подбор аналогов.
- Поставку компонентов в любых объемах, удовлетворяющих вашим потребностям.
- Приемлемые сроки поставки, возможна ускоренная поставка.
- Доставку товара в любую точку России и стран СНГ.
- Комплексную поставку.
- Работу по проектам и поставку образцов.
- Формирование склада под заказчика.
- Сертификаты соответствия на поставляемую продукцию (по желанию клиента).
- Тестирование поставляемой продукции.
- Поставку компонентов, требующих военную и космическую приемку.
- Входной контроль качества.
- Наличие сертификата ISO.

В составе нашей компании организован Конструкторский отдел, призванный помогать разработчикам, и инженерам.

Конструкторский отдел помогает осуществить:

- Регистрацию проекта у производителя компонентов.
- Техническую поддержку проекта.
- Защиту от снятия компонента с производства.
- Оценку стоимости проекта по компонентам.
- Изготовление тестовой платы монтаж и пусконаладочные работы.



Тел: +7 (812) 336 43 04 (многоканальный)
Email: org@lifeelectronics.ru