



Low-Voltage, Single-Supply Dual SPST/SPDT Analog Switches

General Description

The MAX4541–MAX4544 are precision, dual analog switches designed to operate from a single +2.7V to +12V supply. Low power consumption (5 μ W) makes these parts ideal for battery-powered equipment. These switches offer low leakage currents (100pA max) and fast switching speeds (t_{ON} = 150ns max, t_{OFF} = 100ns max).

When powered from a +5V supply, the MAX4541–MAX4544 offer 2 Ω max matching between channels, 60 Ω max on-resistance (R_{ON}), and 6 Ω max R_{ON} flatness.

These switches also offer 5pC max charge injection and a minimum of 2000V ESD protection per Method 3015.7.

The MAX4541/MAX4542/MAX4543 are dual single-pole/single-throw (SPST) devices and the MAX4544 is a single-pole/double-throw (SPDT) device. The MAX4541 has two normally open (NO) switches and the MAX4542 has two normally closed (NC) switches. The MAX4543 has one NO and one NC switch and can be used as an SPDT, while the MAX4544 is an SPDT. The MAX4541/MAX4542/MAX4543 are available in tiny SOT23-8 and 8-pin TDFN packages, and the MAX4544 is available in a SOT23-6 package.

Applications

Battery-Operated Systems	Test Equipment
Sample-and-Hold Circuits	Communications Systems
Heads-Up Displays	+3V/+5V DACs and ADCs
Guidance and Control Systems	PBX, PABX
Audio and Video Switching	Cell Phones
Military Radios	Ultrasound
	Pagers

μ MAX is a registered trademark of Maxim Integrated Products, Inc.

Pin Configurations/Functional Diagrams/Truth Tables

TOP VIEW

μ MAX/SO/DIP/TDFN

SOT23-6*

AAAM

*NOTE: SOT23-6 PACKAGE HAS LETTERING NEAREST PIN 6

MAX4544		
LOGIC	NC	NO
0	ON	OFF
1	OFF	ON

SWITCHES SHOWN FOR "0" INPUT

N.C. = NOT INTERNALLY CONNECTED
MAX4541/MAX4542/MAX4543
APPEAR AT END OF DATA SHEET.

Features

- ◆ 60 Ω max (33 Ω typ) Low R_{ON}
- ◆ 2 Ω max R_{ON} Matching Between Channels
- ◆ 6 Ω max R_{ON} Flatness
- ◆ 5pC max Guaranteed Charge Injection
- ◆ +2.7V to +12V Single-Supply Operation
- ◆ < 5 μ W Low Power Consumption
- ◆ Low Leakage Current Over Temperature: 10nA max at +85°C
- ◆ Fast Switching: t_{ON} = 35ns, t_{OFF} = 25ns
- ◆ Guaranteed Break-Before-Make (MAX4543/MAX4544 Only)
- ◆ TTL/CMOS-Logic Compatible
- ◆ Pin Compatible with MAX323/MAX324/MAX325
- ◆ MAX4541/MAX4542/MAX4543 Available in SOT23-8
MAX4544 Available in SOT23-6

Ordering Information

PART	TEMP RANGE	PIN-PACKAGE	TOP MARK
MAX4541CUA	0°C to +70°C	8 μ MAX [®]	—
MAX4541CSA	0°C to +70°C	8 SO	—
MAX4541CPA	0°C to +70°C	8 Plastic DIP	—
MAX4541C/D	0°C to +70°C	Dice*	—
MAX4541EKA-T	-40°C to +85°C	8 SOT23-8	AAAE
MAX4541ETA	-40°C to +85°C	8 TDFN-EP**	—
MAX4541EUA	-40°C to +85°C	8 μ MAX	—
MAX4541ESA	-40°C to +85°C	8 SO	—

Ordering Information continued at end of data sheet.

*Dice are specified at T_A = +25°C.

**EP = Exposed pad.

MAX4541–MAX4544

Low-Voltage, Single-Supply Dual SPST/SPDT Analog Switches

ABSOLUTE MAXIMUM RATINGS

Voltage Referenced to GND	TDFN (derate 24.4mW/°C above +70°C).....	1951mW
V+	μMAX (derate 4.10mW/°C above +70°C)	330mW
IN_, COM_, NC_, NO_ (Note 1).....	Narrow SO (derate 5.88mW/°C above +70°C)	471mW
Continuous Current (any terminal).....	Plastic DIP (derate 9.09mW/°C above +70°C)	727mW
Peak Current, COM_, NO_, NC_	Operating Temperature Ranges	
(pulsed at 1ms, 10% duty cycle max)	MAX454_C_	0°C to +70°C
ESD per Method 3015.7	MAX454_E_	-40°C to +85°C
Continuous Power Dissipation	Storage Temperature Range	-65°C to +150°C
SOT23-6 (derate 7.1mW/°C above +70°C).....	Lead Temperature (soldering, 10s)	+300°C
SOT23-8 (derate 5.3mW/°C above +70°C).....		

Note 1: Signals on NC_, NO_, COM_, or IN_ exceeding V+ or V- are clamped by internal diodes. Limit forward diode current to maximum current rating.

Stresses beyond those listed under "Absolute Maximum Ratings" may cause permanent damage to the device. These are stress ratings only, and functional operation of the device at these or any other conditions beyond those indicated in the operational sections of the specifications is not implied. Exposure to absolute maximum rating conditions for extended periods may affect device reliability.

ELECTRICAL CHARACTERISTICS—Single +5V Supply

(V+ = +5V ±10%, GND = 0, V_{INH} = 2.4V, V_{INL} = 0.8V, T_A = T_{MIN} to T_{MAX}, unless otherwise noted.) (Notes 2, 3)

PARAMETER	SYMBOL	CONDITIONS		MIN	TYP	MAX	UNITS
ANALOG SWITCH							
Analog Signal Range	V _{COM_} , V _{NO_} , V _{NC_}	(Note 4)		0		V+	V
On-Resistance	R _{ON}	V+ = 4.5V, I _{COM_} = 1.0mA, V _{NO_} or V _{NC_} = 3.5V	T _A = +25°C	30	60		Ω
			T _A = T _{MIN} to T _{MAX}		75		
On-Resistance Match Between Channels (Note 5)	ΔR _{ON}	V+ = 5V, I _{COM_} = 1.0mA, V _{NO_} or V _{NC_} = 3.5V	T _A = +25°C	0.8	2		Ω
			T _A = T _{MIN} to T _{MAX}		4		
On-Resistance Flatness (Note 6)	R _{FLAT(ON)}	V+ = 5V; I _{COM_} = 1.0mA; V _{NO_} or V _{NC_} = 1V, 2V, 3V	T _A = +25°C	2	6		Ω
			T _A = T _{MIN} to T _{MAX}		8		
NO_ or NC_ Off-Leakage Current (Note 7)	I _{NO(OFF)} or I _{NC(OFF)}	V+ = 5.5V; V _{COM_} = 1V, 4.5V; V _{NO_} or V _{NC_} = 4.5V, 1V	T _A = +25°C	-0.1	±0.01	+0.1	nA
			T _A = T _{MIN} to T _{MAX}		-5	+5	
COM_ Off-Leakage Current (Note 7)	I _{COM(OFF)}	V+ = 5.5V; V _{COM_} = 4.5V, 1V; V _{NO_} or V _{NC_} = 1V, 4.5V	T _A = +25°C	-0.1		+0.1	nA
			T _A = T _{MIN} to T _{MAX}		-5	+5	
COM_ On-Leakage Current (Note 7)	I _{COM(ON)}	V+ = 5.5V; V _{COM_} = 1V, 4.5V or V _{NO_} or V _{NC_} = 1V, 4.5V, or floating	T _A = +25°C	-0.2		+0.2	nA
			T _A = T _{MIN} to T _{MAX}		-10	+10	

Low-Voltage, Single-Supply Dual SPST/SPDT Analog Switches

MAX4541-MAX4544

ELECTRICAL CHARACTERISTICS—Single +5V Supply (continued)

(V+ = +5V ±10%, GND = 0, VINH = 2.4V, VINL = 0.8V, TA = TMIN to TMAX, unless otherwise noted.) (Notes 2, 3)

PARAMETER	SYMBOL	CONDITIONS	MIN	TYP	MAX	UNITS
DYNAMIC						
Turn-On Time	tON	VNO_ or VNC_ = 3V, Figure 2	TA = +25°C	35	100	ns
			TA = TMIN to TMAX		240	
Turn-Off Time	tOFF	VNO_ or VNC_ = 3V, Figure 2	TA = +25°C	25	75	ns
			TA = TMIN to TMAX		150	
Break-Before-Make Time Delay (Note 4)	tD	MAX4543/MAX4544 only, RL = 300Ω, CL = 35pF	2	10		ns
Charge Injection (Note 4)	Q	CL = 1.0nF, VGEN = 0, RGEN = 0, TA = +25°C, Figure 4		1	5	pC
Off-Isolation (Note 8)	OIRR	RL = 50Ω, CL = 5pF, f = 1MHz, TA = +25°C, Figure 5		-76		dB
Crosstalk (Note 9)		RL = 50Ω, CL = 5pF, f = 1MHz, TA = +25°C, Figure 6		-90		dB
NC_ or NO_ Capacitance	COFF	f = 1MHz, TA = +25°C, Figure 7		8		pF
COM_ Off-Capacitance	CCOM(OFF)	f = 1MHz, TA = +25°C, Figure 7		8		pF
COM_ On-Capacitance	CCOM(ON)	f = 1MHz, TA = +25°C, Figure 7	MAX4541/MAX4542/ MAX4543	13		pF
			MAX4544	20		
SUPPLY						
Power-Supply Range	V+		2.7		12	V
Positive Supply Current	I+	V+ = 5.5V, VIN = 0 or V+, all channels on or off	-1	±0.0001	+1	μA
LOGIC INPUT						
Input-Voltage Low	VINL				0.8	V
Input-Voltage High	VINH		2.4			V

Low-Voltage, Single-Supply Dual SPST/SPDT Analog Switches

ELECTRICAL CHARACTERISTICS—Single +3.3V Supply

($V_+ = +3.0V$ to $+3.6V$, $GND = 0$, $V_{INH} = 2.4V$, $V_{INL} = 0.8V$, $T_A = T_{MIN}$ to T_{MAX} , unless otherwise noted.) (Notes 2, 3)

PARAMETER	SYMBOL	CONDITIONS		MIN	TYP	MAX	UNITS
ANALOG SWITCH							
Analog Signal Range	$V_{COM_}$, $V_{NO_}$, $V_{NC_}$	(Note 3)		0		V_+	V
Channel On-Resistance	R_{ON}	$V_+ = 3V$, $I_{COM_} = 1.0mA$, $V_{NO_}$ or $V_{NC_} = 1.5V$	$T_A = +25^\circ C$		50	125	Ω
			$T_A = T_{MIN}$ to T_{MAX}			275	
DYNAMIC							
Turn-On Time (Note 3)	t_{ON}	$V_{NO_}$ or $V_{NC_} = 1.5V$	$T_A = +25^\circ C$		80	400	ns
			$T_A = T_{MIN}$ to T_{MAX}			500	
Turn-Off Time (Note 3)	t_{OFF}	$V_{NO_}$ or $V_{NC_} = 1.5V$	$T_A = +25^\circ C$		50	125	ns
			$T_A = T_{MIN}$ to T_{MAX}			175	
Break-Before-Make Time Delay (Note 3)	t_D	MAX4543/MAX4544 only, $R_L = 300\Omega$, $C_L = 35pF$, $T_A = +25^\circ C$		2	30		ns
Charge Injection (Note 3)	Q	$C_L = 1.0nF$, $V_{GEN} = 0$, $R_{GEN} = 0$, $T_A = +25^\circ C$			1	5	pC
SUPPLY							
Positive Supply Current	I_+	$V_+ = 3.6V$, $V_{IN} = 0$ or V_+ , all channels on or off		-1		+1	μA

Note 2: QFN and SOT-packaged parts are 100% tested at $+25^\circ C$ only and guaranteed by correlation at the full hot rated temperature.

Note 3: The algebraic convention, where the most negative value is a minimum and the most positive value a maximum, is used in this data sheet.

Note 4: Guaranteed by design.

Note 5: $\Delta R_{ON} = \Delta R_{ON\ max} - \Delta R_{ON\ min}$.

Note 6: Flatness is defined as the difference between the maximum and minimum value of on-resistance as measured over the specified analog signal range.

Note 7: Leakage parameters are 100% tested at maximum rated hot temperature and guaranteed by correlation at $+25^\circ C$.

Note 8: Off-isolation = $20 \times \log_{10} [V_{COM} / (V_{NC} \text{ or } V_{NO})]$, V_{COM} = output, V_{NC} or V_{NO} = input to off switch.

Note 9: Between the two switches, MAX4541/MAX4542/MAX4543 only.

Low-Voltage, Single-Supply Dual SPST/SPDT Analog Switches

Typical Operating Characteristics

($T_A = +25^\circ\text{C}$, unless otherwise noted.)

MAX4541-MAX4544

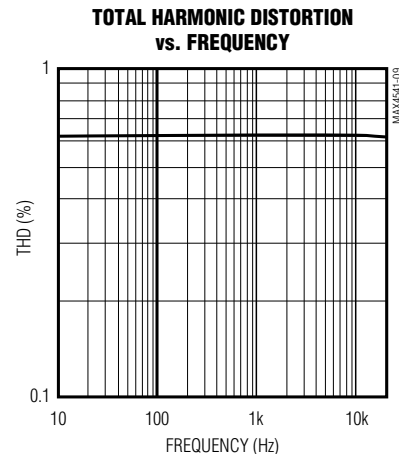
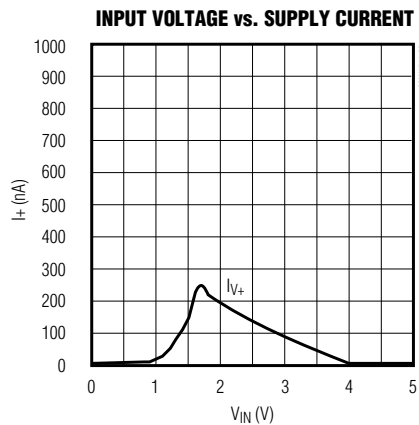
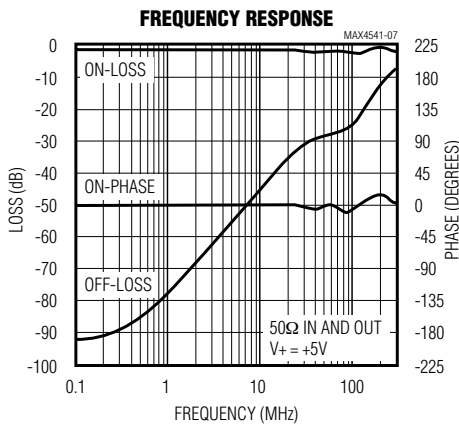
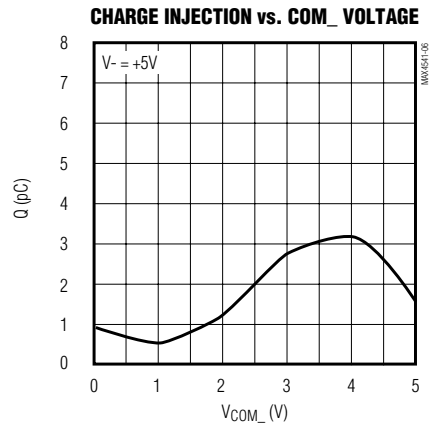
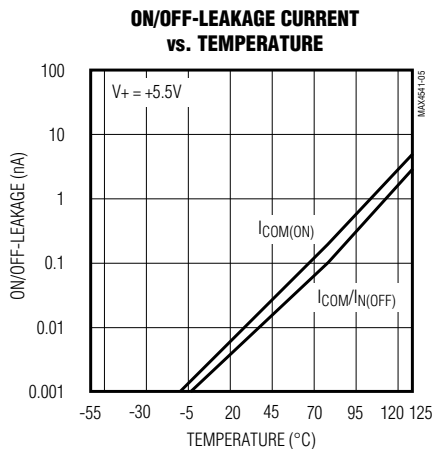
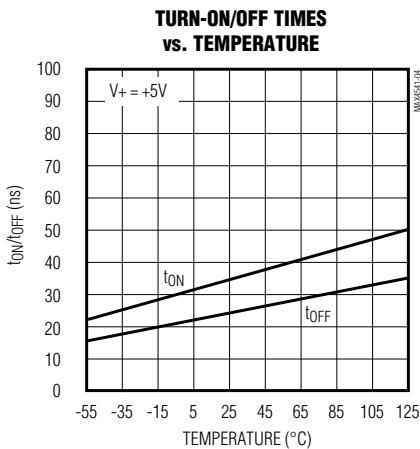
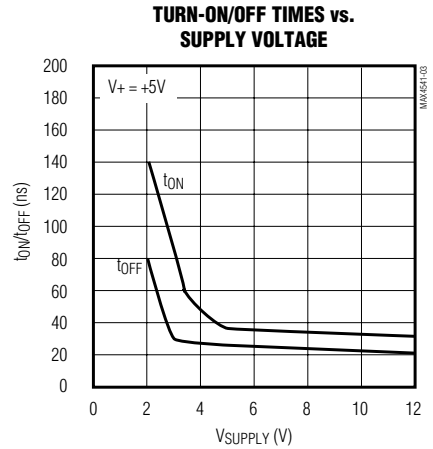
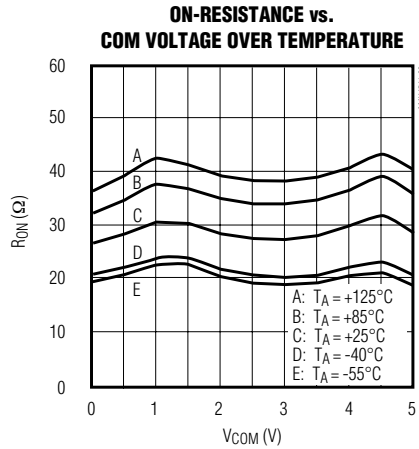
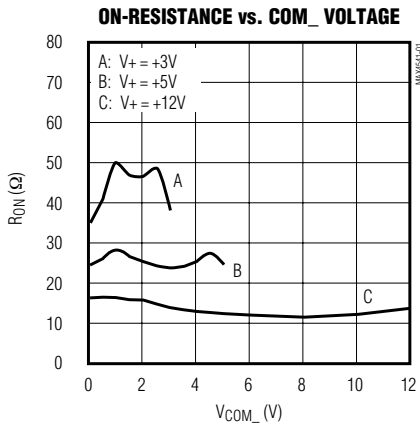

Low-Voltage, Single-Supply Dual SPST/SPDT Analog Switches

Pin Description

PIN								NAME	FUNCTION
MAX4541		MAX4542		MAX4543		MAX4544			
DIP/SO/ μMAX/ TDFN	SOT23-8	DIP/SO/ μMAX/ TDFN	SOT23-8	DIP/SO/ μMAX/ TDFN	SOT23-8	DIP/SO/ μMAX/ TDFN	SOT23-6		
1	1	—	—	1	1	—	—	NO1	Analog Switch 1—Normally Open
2	8	2	8	2	8	—	—	COM1	Analog Switch 1—Common
3	3	3	3	3	3	—	—	IN2	Digital Control Input 2
4	6	4	6	4	6	4	3	GND	Ground—Negative Supply Input
5	5	—	—	—	—	—	—	NO2	Analog Switch 2—Normally Open
6	4	6	4	6	4	—	—	COM2	Analog Switch 2—Common
7	7	7	7	7	7	—	—	IN1	Digital Control Input 1
8	2	8	2	8	2	8	2	V+	Positive Supply Voltage Input
—	—	1	1	—	—	—	—	NC1	Analog Switch 1—Normally Closed
—	—	5	5	5	5	—	—	NC2	Analog Switch 2—Normally Closed
—	—	—	—	—	—	1	6	NO	Analog Switch—Normally Open
—	—	—	—	—	—	2	5	COM	Analog Switch—Common
—	—	—	—	—	—	3	4	NC	Analog Switch—Normally Closed
—	—	—	—	—	—	5, 6	—	N.C.	Not Connected (Open Circuit)
—	—	—	—	—	—	7	1	IN	Digital Control Input
EP	—	EP	—	EP	—	EP	—	EP	Exposed Pad. Connect EP to V+.

Applications Information



Figure 1. Overvoltage Protection Using Two External Blocking Diodes

Logic Levels

The MAX4541–MAX4544 are TTL compatible when powered from a single +5V supply. When powered from other supply voltages, TTL compatibility is guaranteed and the logic inputs can be driven rail-to-rail. For example, with a +12V supply, IN1 and IN2 can be driven low to 0 and high to 12V. With a +3.3V supply, IN1 and IN2 should be driven low to 0 and high to 3.3V.

Driving IN1 and IN2 rail-to-rail minimizes power consumption.

Analog Signal Levels

Analog signals that range over the entire supply voltage (V+ to GND) can be switched with very little change in on-resistance over the entire voltage range (see the *Typical Operating Characteristics*). All the switches are bidirectional, so the NO_, NC_, and COM_ pins can be used as either inputs or outputs.

Low-Voltage, Single-Supply Dual SPST/SPDT Analog Switches

MAX4541-MAX4544

Power-Supply Sequencing and Overvoltage Protection

Do not exceed the absolute maximum ratings because stresses beyond the listed ratings may cause permanent damage to the devices.

Proper power-supply sequencing is recommended for all CMOS devices. Always apply V+ before applying analog signals or logic inputs, especially if the analog or logic signals are not current limited. If this sequencing is not possible, and if the analog or logic inputs are not current limited to < 10mA, add a small-signal diode (D1) as shown in Figure 1. If the analog signal can dip below GND, add D2. Adding protection diodes reduces the analog signal range to a diode drop (about 0.7V) below V+ (for D1), and to a diode drop above ground (for D2). Leakage is unaffected by adding the diodes. On-resistance increases by a small amount at low supply voltages. Maximum supply voltage (V+) must not exceed 13V.

Adding protection diodes causes the logic thresholds to be shifted relative to the power-supply rails. This can be significant when low supply voltages (+5V or less) are used. With a +5V supply, TTL compatibility is not guaranteed when protection diodes are added. Driving IN1 and IN2 all the way to the supply rails (i.e., to a diode drop higher than the V+ pin, or to a diode drop lower than the GND pin) is always acceptable.

Protection diodes D1 and D2 also protect against some overvoltage situations. With Figure 1's circuit, if the supply voltage is below the absolute maximum rating, and if a fault voltage up to the absolute maximum rating is applied to an analog signal pin, no damage will result.

Test Circuits/Timing Diagrams



Figure 2. Switching Time

Low-Voltage, Single-Supply Dual SPST/SPDT Analog Switches

Test Circuits/Timing Diagrams (continued)



Figure 3a. Break-Before-Make Interval (MAX4543 Only)



Figure 3b. Break-Before-Make Interval (MAX4544 Only)



Figure 4. Charge Injection

Low-Voltage, Single-Supply Dual SPST/SPDT Analog Switches

Test Circuits/Timing Diagrams (continued)

MAX4541-MAX4544



Figure 5. Off-Isolation



Figure 6. Crosstalk



Figure 7. Channel Off/On-Capacitance

Low-Voltage, Single-Supply Dual SPST/SPDT Analog Switches

Ordering Information (continued)

PART	TEMP RANGE	PIN-PACKAGE	TOP MARK
MAX4541EPA	-40°C to +85°C	8 Plastic DIP	—
MAX4542 CUA	0°C to +70°C	8 μ MAX	—
MAX4542CSA	0°C to +70°C	8 SO	—
MAX4542CPA	0°C to +70°C	8 Plastic DIP	—
MAX4542C/D	0°C to +70°C	Dice*	—
MAX4542EKA-T	-40°C to +85°C	8 SOT23-8	AAAF
MAX4542ETA	-40°C to +85°C	8 TDFN-EP**	—
MAX4542EUA	-40°C to +85°C	8 μ MAX	—
MAX4542ESA	-40°C to +85°C	8 SO	—
MAX4542EPA	-40°C to +85°C	8 Plastic DIP	—
MAX4543 CUA	0°C to +70°C	8 μ MAX	—
MAX4543CSA	0°C to +70°C	8 SO	—
MAX4543CPA	0°C to +70°C	8 Plastic DIP	—
MAX4543C/D	0°C to +70°C	Dice*	—
MAX4543EKA-T	-40°C to +85°C	8 SOT23-8	AAAG
MAX4543ETA	-40°C to +85°C	8 TDFN-EP**	—
MAX4543EUA	-40°C to +85°C	8 μ MAX	—
MAX4543ESA	-40°C to +85°C	8 SO	—
MAX4543EPA	-40°C to +85°C	8 Plastic DIP	—
MAX4544 CUA	0°C to +70°C	8 μ MAX	—
MAX4544CSA	0°C to +70°C	8 SO	—
MAX4544CPA	0°C to +70°C	8 Plastic DIP	—
MAX4544C/D	0°C to +70°C	Dice*	—
MAX4544EUT-T	-40°C to +85°C	6 SOT23-6	AAAM
MAX4544ETA	-40°C to +85°C	8 TDFN-EP**	—
MAX4544EUA	-40°C to +85°C	8 μ MAX	—
MAX4544ESA	-40°C to +85°C	8 SO	—
MAX4544EPA	-40°C to +85°C	8 Plastic DIP	—

*Dice are specified at $T_A = +25^\circ\text{C}$.

**EP = Exposed pad.

Low-Voltage, Single-Supply Dual SPST/SPDT Analog Switches

Pin Configurations/Functional Diagrams/Truth Tables (continued)



MAX4541-MAX4544

Low-Voltage, Single-Supply Dual SPST/SPDT Analog Switches

Package Information

(The package drawing(s) in this data sheet may not reflect the most current specifications. For the latest package outline information go to www.maxim-ic.com/packages.)



Low-Voltage, Single-Supply Dual SPST/SPDT Analog Switches

Package Information (continued)

(The package drawing(s) in this data sheet may not reflect the most current specifications. For the latest package outline information go to www.maxim-ic.com/packages.)

MAX4541-MAX4544

COMMON DIMENSIONS		
SYMBOL	MIN.	MAX.
A	0.70	0.80
D	2.90	3.10
E	2.90	3.10
A1	0.00	0.05
L	0.20	0.40
k	0.25 MIN.	
A2	0.20 REF.	

PACKAGE VARIATIONS								
PKG. CODE	N	D2	E2	e	JEDEC SPEC	b	[(N/2)-1] x e	
T633-2	6	1.50±0.10	2.30±0.10	0.95 BSC	MO229 / WEEA	0.40±0.05	1.90 REF	
T833-2	8	1.50±0.10	2.30±0.10	0.65 BSC	MO229 / WEEC	0.30±0.05	1.95 REF	
T833-3	8	1.50±0.10	2.30±0.10	0.65 BSC	MO229 / WEEC	0.30±0.05	1.95 REF	
T1033-1	10	1.50±0.10	2.30±0.10	0.50 BSC	MO229 / WEED-3	0.25±0.05	2.00 REF	
T1033-2	10	1.50±0.10	2.30±0.10	0.50 BSC	MO229 / WEED-3	0.25±0.05	2.00 REF	
T1433-1	14	1.70±0.10	2.30±0.10	0.40 BSC	----	0.20±0.05	2.40 REF	
T1433-2	14	1.70±0.10	2.30±0.10	0.40 BSC	----	0.20±0.05	2.40 REF	

NOTES:

- ALL DIMENSIONS ARE IN mm. ANGLES IN DEGREES.
- COPLANARITY SHALL NOT EXCEED 0.08 mm.
- WARPAGE SHALL NOT EXCEED 0.10 mm.
- PACKAGE LENGTH/PACKAGE WIDTH ARE CONSIDERED AS SPECIAL CHARACTERISTIC(S).
- DRAWING CONFORMS TO JEDEC MO229, EXCEPT DIMENSIONS "D2" AND "E2", AND T1433-1 & T1433-2.
- "N" IS THE TOTAL NUMBER OF LEADS.
- NUMBER OF LEADS SHOWN ARE FOR REFERENCE ONLY.
-  MARKING IS FOR PACKAGE ORIENTATION REFERENCE ONLY.

		
TITLE: PACKAGE OUTLINE, 6,8,10 & 14L, TDFN, EXPOSED PAD, 3x3x0.80 mm		
APPROVAL	DOCUMENT CONTROL NO.	REV.
	21-0137	I 2/2

-DRAWING NOT TO SCALE-

Low-Voltage, Single-Supply Dual SPST/SPDT Analog Switches

Package Information (continued)

(The package drawing(s) in this data sheet may not reflect the most current specifications. For the latest package outline information go to www.maxim-ic.com/packages.)

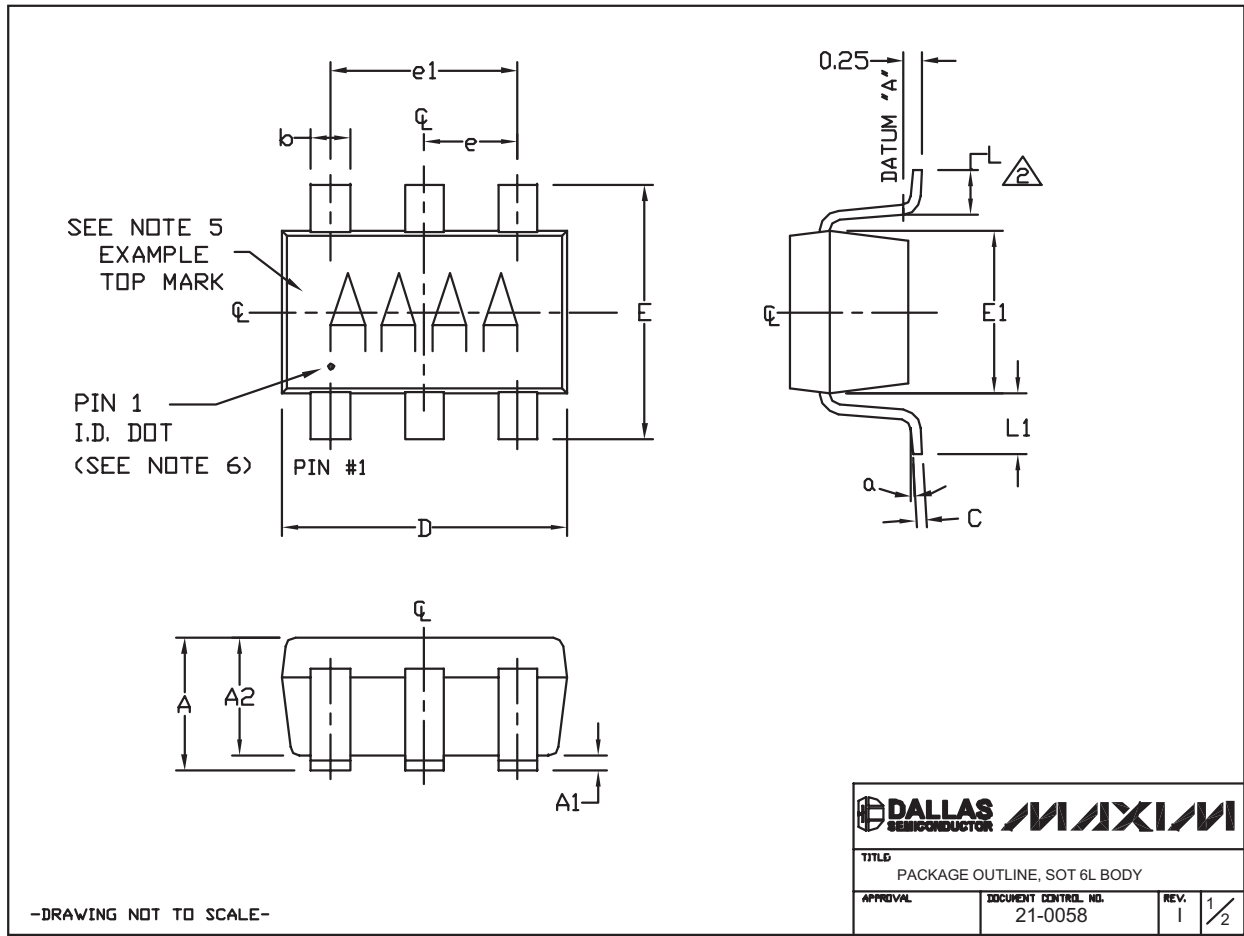

Low-Voltage, Single-Supply Dual SPST/SPDT Analog Switches

Package Information (continued)

(The package drawing(s) in this data sheet may not reflect the most current specifications. For the latest package outline information go to www.maxim-ic.com/packages.)

MAX4541-MAX4544

NOTES:

1. ALL DIMENSIONS ARE IN MILLIMETERS.
2.  FOOT LENGTH MEASURED AT INTERCEPT POINT BETWEEN DATUM A & LEAD SURFACE.
3. PACKAGE OUTLINE EXCLUSIVE OF MOLD FLASH & METAL BURR. MOLD FLASH, PROTRUSION OR METAL BURR SHOULD NOT EXCEED 0.25mm.
4. PACKAGE OUTLINE INCLUSIVE OF SOLDER PLATING.
5. PIN 1 IS LOWER LEFT PIN WHEN READING TOP MARK FROM LEFT TO RIGHT. (SEE EXAMPLE TOP MARK)
6. PIN 1 I.D. DOT IS 0.3mm ϕ MIN. LOCATED ABOVE PIN 1.
7. MEETS JEDEC MO178, VARIATION AB.
8. SOLDER THICKNESS MEASURED AT FLAT SECTION OF LEAD BETWEEN 0.08mm AND 0.15mm FROM LEADTIP.
9. LEAD TO BE COPLANAR WITHIN 0.1mm.
10. NUMBER OF LEADS SHOWN ARE FOR REFERENCE ONLY.
11. MARKING IS FOR PACKAGE ORIENTATION REFERENCE ONLY.

SYMBOL	MIN	NOMINAL	MAX
A	0.90	1.25	1.45
A1	0.00	0.05	0.15
A2	0.90	1.10	1.30
b	0.35	0.40	0.50
C	0.08	0.15	0.20
D	2.80	2.90	3.00
E	2.60	2.80	3.00
E1	1.50	1.625	1.75
L	0.35	0.45	0.60
L1	0.60 REF.		
e1	1.90 BSC.		
e	0.95 BSC.		
a	0°	2.5°	10°

PKG CODES:
U6-1, U6-2, U6-4, U6C-8,
U6SN-1, U6CN-2, U6S-3, U6F-5,
U6F-6, U6FH-5, U6FH-6

-DRAWING NOT TO SCALE-

			
TITLED			
PACKAGE OUTLINE, SOT 6L BODY			
APPROVAL	DOCUMENT CONTROL NO.	REV.	2/2
	21-0058	1	

Low-Voltage, Single-Supply Dual SPST/SPDT Analog Switches

Package Information (continued)

(The package drawing(s) in this data sheet may not reflect the most current specifications. For the latest package outline information go to www.maxim-ic.com/packages.)



SOT23, 8L EPS

Revision History

Pages changed at Rev 4: 1-16

Maxim cannot assume responsibility for use of any circuitry other than circuitry entirely embodied in a Maxim product. No circuit patent licenses are implied. Maxim reserves the right to change the circuitry and specifications without notice at any time.

16 **Maxim Integrated Products, 120 San Gabriel Drive, Sunnyvale, CA 94086 408-737-7600**

Компания «Life Electronics» занимается поставками электронных компонентов импортного и отечественного производства от производителей и со складов крупных дистрибьюторов Европы, Америки и Азии.

С конца 2013 года компания активно расширяет линейку поставок компонентов по направлению коаксиальный кабель, кварцевые генераторы и конденсаторы (керамические, пленочные, электролитические), за счёт заключения дистрибьюторских договоров

Мы предлагаем:

- Конкурентоспособные цены и скидки постоянным клиентам.
- Специальные условия для постоянных клиентов.
- Подбор аналогов.
- Поставку компонентов в любых объемах, удовлетворяющих вашим потребностям.
- Приемлемые сроки поставки, возможна ускоренная поставка.
- Доставку товара в любую точку России и стран СНГ.
- Комплексную поставку.
- Работу по проектам и поставку образцов.
- Формирование склада под заказчика.
- Сертификаты соответствия на поставляемую продукцию (по желанию клиента).
- Тестирование поставляемой продукции.
- Поставку компонентов, требующих военную и космическую приемку.
- Входной контроль качества.
- Наличие сертификата ISO.

В составе нашей компании организован Конструкторский отдел, призванный помогать разработчикам, и инженерам.

Конструкторский отдел помогает осуществить:

- Регистрацию проекта у производителя компонентов.
- Техническую поддержку проекта.
- Защиту от снятия компонента с производства.
- Оценку стоимости проекта по компонентам.
- Изготовление тестовой платы монтаж и пусконаладочные работы.



Тел: +7 (812) 336 43 04 (многоканальный)

Email: org@lifeelectronics.ru