

Kunde / customer :
 Artikelnummer / part number : **820 522 511**

Datum / Date : **2006-06-29**

Bezeichnung :
 description : **STANDARD VARISTOR DISC**

DIAM: **20** MM

ROHS Compliant

A Elektrische Eigenschaften / electrical properties :

TECHNICAL DATA

Part Number	Breakdown Voltage	Tolerance	Working Voltage		Clamping Voltage	Current Clamp. Volt.	Peak Current Withstanding C.
	(V@mA) (*1)		(%)	AC			
820522511	390	10	250	320	650	100	6500

- * 1 The varistor voltage was measured at 0.1 mA current for 5 mm diameter and 1 mA current for other
- * 2 The Clamping voltage measured at "Current Clamping Voltage" see next column
- * 3 The Peak Current was tested at 8/20 us waveform for 1 time

Part Number	Rated Wattage	Energy	Capacitance	UL	Certification		Diameter
	(W)				J (*4)	pF (*5)	
820522511	1.0	240.0	980	yes	yes	yes	20

- * 4. The Energy measured at 10/1000 µs waveform for 1 time
- * 5. The capacitance value measured at standard frequency @ 1kHz
- * 6. Certification UL N° XUHT2.E244196
- * 7. Certification CSA N° XUHT8.E244196
- * 8. Certification VDE N° 40016998 & 40016986

SURGE LEVEL IEC61000-4-5

Severity Level	(kV)
1	0,5
2	1
3	2
4	4
X	Special

Wave shape "Short circuit" (Current Isc)

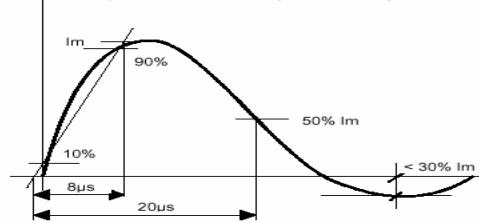

Wave during	T1	T2
8/20 µs	10 µs	1000 µs
10/700 µs CCITT	10 µs	700 µs
10/1000 µs	10 µs	1000 µs

ORDER CODE

820

MARKING CODE

X X XXX X

S

Varistor Type

Serie

Diameter

Vrms Voltage

Tolerance

Other

Special Type

Disc Varistor

5 = Standard
 4 = High Surge

5 = 5 mm
 7 = 7 mm
 1 = 10 mm
 4 = 14 mm
 2 = 20 mm

Example:
 180 = 18 V
 271 = 270 V
 102 = 1 000 V

5 = 5%
 1 = 10%
 6 = 15%
 2 = 20%
 7 = 25%
 3 = 30%

Lead Diameter See Table
 Lead Pitch See Table
 Lead Style Straight lead
 Packing Ammopack with lead 20 mm

Kunde / customer :

Artikelnummer / part number : **820522511**

Bezeichnung :

description : **STANDARD VARISTOR DISC**

DIAM: **20** MM

B Mechanische Abmessungen / dimensions :

SIZE

Diameter*	Ø 5	Ø 7	Ø 10	Ø 14	Ø 20
D max.	7,5	9,0	12,5	16,5	23,0
d +/-0,05	0,6	0,6	0,6/0,8	0,8/1,0	0,8/1,0
F +/-1,0	5,0	5,0	5,0/7,5	7,5/10,0	7,5/10,0
H max.	11	13	18	22	28
H1 max	3,5	3,5	5,0	5,0	5,0
L1 min.	25	25	25	25	25
L min.	24	24	24	24	24

(mm) - *Disc diameter before epoxy

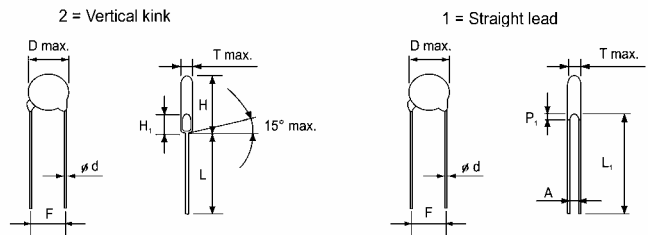

Table of T max., A & P₁. Unit : (mm)

Voltage Code	Ø 5			Ø 7			Ø 10			Ø 14			Ø 20		
	T max	A +/-0,8	P ₁	T max	A +/-0,8	P ₁	T max	A +/-0,8	P ₁	T max	A +/-0,8	P ₁	T max	A +/-0,8	P ₁
180	4,5	1,4	3,0	4,5	1,4	3,0	4,9	1,4	3,0	5,0	1,5	3,0	5,2	1,5	3,0
220	4,5	1,5	3,0	4,5	1,5	3,0	4,9	1,5	3,0	5,0	1,6	3,0	5,3	1,6	3,0
270	4,7	1,5	3,0	4,7	1,5	3,0	5,1	1,5	3,0	5,2	1,7	3,0	5,4	1,7	3,0
330	4,7	1,6	3,0	4,7	1,6	3,0	5,1	1,6	3,0	5,2	1,8	3,0	5,4	1,8	3,0
390	4,7	1,8	3,0	4,7	1,8	3,0	5,1	1,8	3,0	5,2	2,0	3,0	5,4	2,0	3,0
470	5,0	1,8	3,0	5,0	1,8	3,0	5,5	1,8	3,0	5,6	2,0	3,0	5,6	2,0	3,0
560	5,0	2,0	3,0	5,0	2,0	3,0	5,5	2,0	3,0	5,6	2,2	3,0	5,6	2,2	3,0
680	5,5	2,3	3,0	5,5	2,3	3,0	6,0	2,3	3,0	6,1	2,5	3,0	6,1	2,5	3,0
820	3,8	1,4	3,0	3,8	1,4	3,0	4,3	1,4	3,0	4,4	1,6	3,0	4,9	1,8	3,0
101	3,9	1,4	3,0	3,9	1,4	3,0	4,4	1,4	3,0	4,5	1,6	3,0	5,1	1,8	3,0
121	4,1	1,5	3,0	4,1	1,5	3,0	4,5	1,5	3,0	4,6	1,7	3,0	5,3	1,9	3,0
151	4,5	1,8	3,0	4,5	1,8	3,0	4,9	1,8	3,0	5,1	2,0	3,0	5,6	2,2	3,0
181	4,1	1,6	3,0	4,1	1,6	3,0	4,5	1,6	3,0	4,7	1,8	3,0	5,2	2,0	3,0
201	4,2	1,6	3,0	4,2	1,6	3,0	4,6	1,6	3,0	4,8	1,8	3,0	5,3	2,0	3,0
221	4,3	1,7	3,0	4,3	1,7	3,0	4,7	1,7	3,0	4,9	1,9	3,0	5,4	2,1	3,0
241	4,4	1,7	3,0	4,4	1,9	3,0	4,8	1,9	3,0	5,0	2,1	3,0	5,5	2,3	3,0
271	4,6	1,9	3,0	4,6	2,0	3,0	5,0	2,0	3,0	5,2	2,1	3,0	5,7	2,5	3,0
301	4,8	1,9	3,0	4,8	2,1	3,0	5,2	2,2	3,0	5,4	2,3	3,0	5,9	2,7	3,0
331	4,9	1,9	3,0	4,9	2,1	3,0	5,3	2,2	3,0	5,5	2,3	3,0	6,0	2,7	3,0
361	5,1	2,4	3,0	5,1	2,5	3,0	5,5	2,5	3,0	5,7	2,7	3,0	6,2	2,9	3,0
391	5,3	2,6	3,5	5,3	2,6	3,5	5,7	2,8	3,5	5,9	2,8	3,5	6,4	3,0	3,5
431	6,1	2,7	3,5	6,1	2,9	3,5	6,5	3,1	3,5	6,7	3,1	3,5	7,2	3,3	3,5
471	6,4	2,8	3,5	6,4	2,9	3,5	6,8	3,2	3,5	7,0	3,3	3,5	7,5	3,5	4,0
511	6,6	3,1	4,0	6,6	3,1	4,0	7,0	3,7	4,0	7,2	3,7	4,0	7,7	3,9	4,0
561	6,9	3,4	4,0	6,9	3,4	4,0	7,3	4,0	4,0	7,5	4,0	4,0	8,0	4,2	4,0
621	7,2	3,7	4,0	7,2	3,7	4,0	7,6	4,6	4,0	7,8	4,4	4,0	8,3	4,7	4,0
681	7,5	4,0	4,0	7,5	4,0	4,0	8,0	5,0	4,0	8,2	4,7	4,0	8,7	5,0	4,0
751	7,9	4,3	4,0	7,9	4,3	4,0	8,4	5,0	4,0	8,6	4,9	4,0	9,1	5,1	4,0
781				8,1	4,5	4,0	8,6	5,2	4,0	8,8	5,2	4,0	9,3	5,4	4,0
821				8,3	4,7	4,0	8,8	5,2	4,0	9,0	5,2	4,0	9,5	5,4	4,0
911							9,4	6,0	4,0	9,6	6,0	4,0	10,1	6,3	4,0
102							9,9	6,0	4,0	10,1	6,2	4,0	10,7	6,4	4,0
112							10,5	6,3	4,0	10,7	6,7	4,0	11,2	6,9	4,0
182							12,6	9,8	6,0	12,8	10,2	6,0	13,5	10,4	6,0

Kunde / customer :

Artikelnummer / part number : **820522511**

Bezeichnung :

description : **STANDARD VARISTOR DISC**DIAM: **20** MM**C Lötpad / soldering spec. :**

MARKING

Würth Elektronik

Characteristic

Certification

Date Code

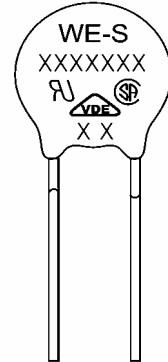
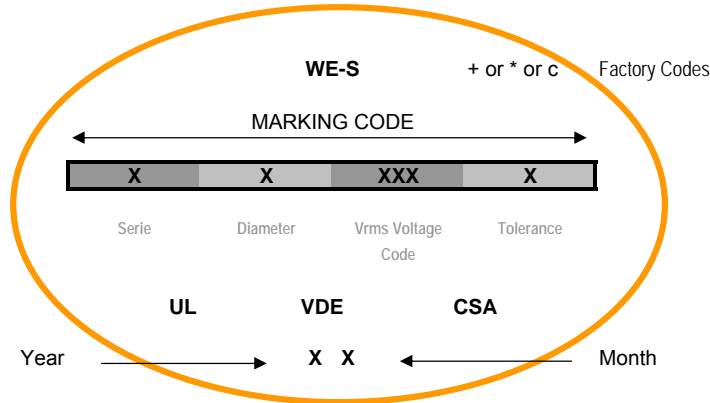

GENERAL CHARACTERISTICS

Storage temperature :	-40 / +125°C
Max. reponse time :	25 n sec
Max. operating temperature :	-40 / +125°C
Temp. Coefficient of voltage :	0 - 0.05% / °C max
Max. working surface temperature :	+115°C
Insulation resistance (at DC 500V) :	Over 1000 Mohm

LEAD FREE SOLDERING

Solder	Tin 100%
Soldering temperature at	255°C +/-5 °C
Profile soldering	270°C during 10s

 Würth Elektronik eiSos GmbH & Co.KG - Radialex department

 D-74638 Waldenburg · Max-Eyth-Straße 1 - 3 · Germany · Telefon (+49) (0) 7942 - 945 - 0 · Telefax (+49) (0) 7942 - 945 - 400
<http://www.we-online.com>

Kunde / customer :

Artikelnummer / part number : **820522511**

Bezeichnung :

description : **STANDARD VARISTOR DISC**DIAM: **20** MM**D Rollenspezifikation / tape and reel specification :**

TAPE 1/2" pitch

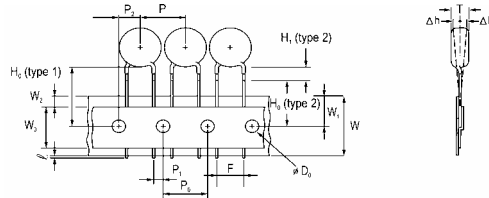

1.0" pitch

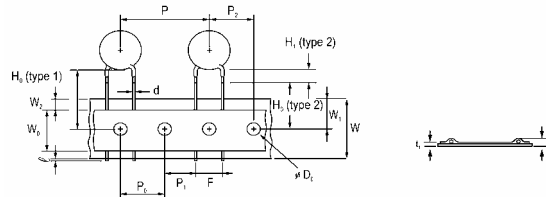

Item	Ø 5 / 7	Ø 10	Ø 10 / 14 / 20	Ø 14 / 20
Taping pitch	1/2"		1.0"	
l	1,1 mm maxi.		1,1 mm maxi.	
H ₁ (type 2)	3,5 mm maxi.	5 mm maxi.	5 mm maxi.	
H ₀ (type 2)	16 +/-0,5 mm		16 +/-0,5 mm	
H ₀ (type 1)	16 à 21 mm		16 à 21 mm	
h	+/-2 mm		+/-2 mm	
W	18 mm +1 / - 0,5 mm		18 mm +1 / - 0,5 mm	
W ₀	10 mm		12 mm	
W ₁	9 mm +0,75 / -0,5 mm		9 mm +0,75 / -0,5 mm	
W ₂	3 mm maxi.		3 mm maxi.	
F	5 mm +0,8 / -0,2 mm		7,5 mm +0,8 / -0,2 mm	10 mm +0,8 / -0,2 mm
P	12,7 mm +/-1 mm		25,4 mm +/-1 mm	
P ₀	12,7 mm +/-0,3 mm		12,7 mm +/-0,3 mm	
P ₁	3,85 mm +/-0,7 mm		8,95 mm +/-0,7 mm	7,7 mm +/-0,7 mm
P ₂	6,35 mm +/-1,3 mm		12,7 mm +/-1,3 mm	
D ₀	4 mm +/-0,2 mm		4 mm +/-0,2 mm	
d	0,6 mm +/-0,05 mm		0,8 mm +/-0,05 mm	1,0 mm +/-0,05 mm
T	See T max. table		See T max. table	
t ₁	0,7 mm +/-0,05 mm		0,6 mm +/-0,05 mm	
t ₂	1,6 mm maxi.		1,8 mm maxi.	

Kunde / customer :

Artikelnummer / part number : **820522511**

Bezeichnung :

description : **STANDARD VARISTOR DISC**

DIAM: **20** MM

D Rollenspezifikation / tape and reel specification :

REEL DIMENSION

(Unit : mm)

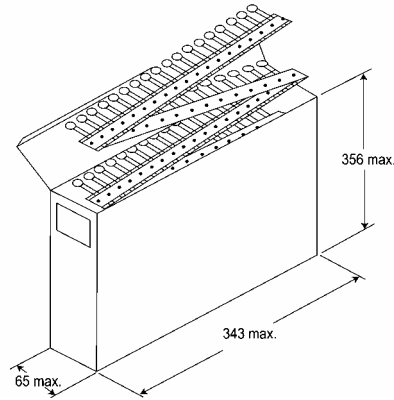
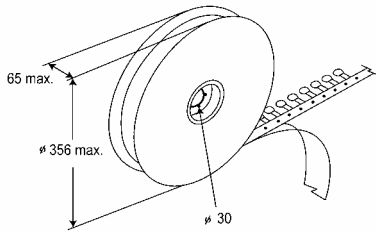

Lead Free "LF" Marking

QUANTITY PER PACKING UNIT

Diameter	Ø 5			Ø 7			Ø 10				Ø 14			Ø 20		
	Bulk	Reel	Ammo	Bulk	Reel	Ammo	Bulk	Reel	Ammo	Ammo	Bulk	Reel	Ammo	Bulk	Reel	Ammo
Voltage Serie	(Box)			(Box)			(Box)		Pitch 7,5 Pitch 5		(Box)			(Box)		
180 à 470	5000	1500	1500	5000	1500	1500	2500	1000	500	1000	1500	750	500	750	500	500
560 à 680	5000	1500	1500	5000	1500	1500	2500	1000	500	1000	1500	750	500	750	500	500
820 à 331	5000	1500	1500	5000	1500	1500	2500	1000	500	1000	1500	750	500	750	500	500
361 à 391	5000	1500	1000	5000	1500	1000	2500	1000	500	1000	1500	750	500	750	500	500
431 à 471	5000	1500	1000	5000	1000	1000	2500	750	500	750	1500	750	500	750	500	500
511 à 751	4000	1000	1000	4000	1000	1000	1500	500	500	500	750	500	500	450	500	500
781 à 182	-	-	-	-	-	-	1500	500	500	500	750	500	500	450	500	500

QUANTITY PER CARTON UNIT

Packaging	Bulk (Box)	Reel	Reel Ø 14 / 20	Ammopack	Ammo Ø 14 / 20
Box size	290 x 155 x 110	350 x 350 x 108	350 x 350 x 74	330 x 240 x 45	350 x 260 x 65
Carton size	310 x 328 x 250	371 x 371 x 590	370 x 370 x 468	354 x 515 x 258	365 x 535 x 275
One carton with	4 boxes	5 boxes (10 reels)	6 boxes	10 boxes	8 boxes
Unit:(mm)					

Würth Elektronik eiSos GmbH & Co.KG - Radialex department

D-74638 Waldenburg · Max-Eyth-Straße 1 - 3 · Germany · Telefon (+49) (0) 7942 - 945 - 0 · Telefax (+49) (0) 7942 - 945 - 400
<http://www.we-online.com>

Kunde / customer :
 Artikelnummer / part number : 820 522 511
 Bezeichnung :
 description : STANDARD VARISTOR DISC DIAM: 20 MM

E Testbedingungen / test conditions :

BASIC TEST AND ENVIRONMENTAL RELIABILITY TEST

<p>Humidity The specimen shall be subjected to 40±2°C, 90 to 95% R.H. For 1000 hours without load and then stored at room temperature and normal humidity for 1 to 2 hours. Thereafter, the change of Vn shall be measured and meet the requirement of: $\Delta Vn/Vn \leq \pm 5\%$</p> <p>Impulse life The impulse current listed on catalog is applied 1000 times continuously with the interval of 30 seconds at room temperature. The change of Vn shall be measured $\Delta Vn/Vn \leq \pm 10\%$</p> <p>Low temperature The specimen shall be subjected to 40 ±2°C without load for 1000 hours and then stored at room temperature and normal humidity for 1 to 2 hours. Thereafter, the change of Vn shall be measured and meet the requirement of $\Delta Vn/Vn \leq \pm 5\%$.</p> <p>High temperature load After being continuously applied the maximum allowable Voltage at 85 ±2°C for 1000 hours, the specimen shall be stored at room temperature and humidity for 1 to 2 hours. The change of Vn shall be measured and meet the requirement of $Vn/Vn \leq \pm 10\%$.</p> <p>High temperature storage The specimen shall be subjected to 125 ±1°C for 1000 hours. In a drying oven without load stored at room temperature and humidity for 1 to 2 hours. The change of Vn shall be measured and meet the requirement of $\Delta Vn/Vn \leq \pm 5\%$.</p> <p>Withstanding Voltage The specified voltage shall be applied between both terminals of the specimen connected together for 1 minute, with no remarkable mechanical damage.</p> <p>Withstanding Voltage (Body Insulation)</p> <table border="1"> <tr> <td>Classification (Nom. varistor voltage)</td> <td>Test Voltage (AC)</td> </tr> <tr> <td>$V_{0,1mA} - V_{1mA} \leq 330 V$</td> <td>1 000 Vrms</td> </tr> <tr> <td>$V_{0,1mA} - V_{1mA} > 330 V$</td> <td>1 500 Vrms</td> </tr> </table>	Classification (Nom. varistor voltage)	Test Voltage (AC)	$V_{0,1mA} - V_{1mA} \leq 330 V$	1 000 Vrms	$V_{0,1mA} - V_{1mA} > 330 V$	1 500 Vrms	<p>Terminal bending strength The unit shall be secured with its terminal kept vertical and the weight specified above shall be applied in the axial direction. The terminal shall gradually be bent 90° in one direction, then 90° in the opposite direction, and again back to the original position. A bend of lead wire shall be repeated 2 times, with no remarkable mechanical damage. Loading weight in bending strength 5N (0.51Kg) 5N (0.51Kg) 10N (1.02Kg)</p> <p>Vibration Subjected to simple harmonic motion of 0.75 mm amplitude 1.5 mm maximum total excursion between limits of 10-55 Hz. Frequency scan shall be traversed in one minute. This motion shall then be applied for period of 2 hours in each of three mutually perpendicular directions, with no remarkable mechanical damage.</p> <p>Solderability After dipping the terminal to a depth of approximately 3mm from the body in a soldering bath of 235 ±5°C for 2 ±0.5 seconds, the terminal shall be visually examined. Approximately 95% of the terminals shall be covered with new solder uniformly.</p> <p>Resistance to soldering heat The terminal shall be dipped into a soldering bath with temperature of 260 ±5°C to a point of 2~2.5 mm from the body of the unit, be held there for 10 ±1 sec (5N series: 5 ±1 sec) and then be stored at room temperature and humidity for 1 to 2 hours. The change of Vn shall be measured and meet the requirement of $\Delta Vn/Vn \leq \pm 5\%$ with no remarkable mechanical damage.</p> <p>Damp heat load The specimen shall be subjected to 40 ±2°C, 90 to 95% R.H. and the maximum allowable voltage for 100 hours and then stored at room temperature and normally humidity for 1 to 2 hours. The change of Vn shall be measured and meet the requirement of $\Delta Vn/Vn \leq \pm 10\%$.</p> <p>Temperature cycle The temperature cycle is repeated five cycles with (1)-40 ±3°C keeping 30 ±3 minutes then (2) room temperature keeping 15 ±3 minutes then (3)125 ±2°C keeping 30 ±3 minutes then (4) room temperature keeping 15 ±3 minutes and then stored at room temperature and humidity for 1 to 2 hours. The change of Vn shall be measured and meet requirement $\Delta Vn/Vn \leq \pm 5\%$ with no remarkable mechanical damage.</p> <p>Terminal pull strength After gradually applying the load specified below and keeping the unit fixed for 10 ±1 seconds, with no remarkable mechanical damage.</p> <table border="1"> <tr> <td>Terminal diameter</td> <td>Loading weight in pull strength</td> </tr> <tr> <td>0.6mm (0.024")</td> <td>10N (1.02Kg)</td> </tr> <tr> <td>0.8 mm (0.031")</td> <td>10N (1.02Kg)</td> </tr> <tr> <td>1.0 mm (0.039")</td> <td>20N (2.04Kg)</td> </tr> </table>	Terminal diameter	Loading weight in pull strength	0.6mm (0.024")	10N (1.02Kg)	0.8 mm (0.031")	10N (1.02Kg)	1.0 mm (0.039")	20N (2.04Kg)
Classification (Nom. varistor voltage)	Test Voltage (AC)														
$V_{0,1mA} - V_{1mA} \leq 330 V$	1 000 Vrms														
$V_{0,1mA} - V_{1mA} > 330 V$	1 500 Vrms														
Terminal diameter	Loading weight in pull strength														
0.6mm (0.024")	10N (1.02Kg)														
0.8 mm (0.031")	10N (1.02Kg)														
1.0 mm (0.039")	20N (2.04Kg)														

Freigabe erteilt / general release:	Kunde / customer			
Datum / date	Unterschrift / signature	JP Penlou	New P/N	2006-06-01
	Würth Elektronik	JP Penlou	Customer Layout	2006-05-11
		JP Penlou	Factory codes	2005-11-16
		JP Penlou	Lead Free Marking	2004-10-19
Geprüft / checked	2006-06-01	Kontrolliert / approved	JP. Penlou	
		Name	Änderung / modification	Datum / date

Würth Elektronik eiSos GmbH & Co.KG - Radialex department

D-74638 Waldenburg · Max-Eyth-Straße 1 - 3 · Germany · Telefon (+49) (0) 7942 - 945 - 0 · Telefax (+49) (0) 7942 - 945 - 400
<http://www.we-online.com>

Компания «Life Electronics» занимается поставками электронных компонентов импортного и отечественного производства от производителей и со складов крупных дистрибьюторов Европы, Америки и Азии.

С конца 2013 года компания активно расширяет линейку поставок компонентов по направлению коаксиальный кабель, кварцевые генераторы и конденсаторы (керамические, пленочные, электролитические), за счёт заключения дистрибьюторских договоров

Мы предлагаем:

- Конкурентоспособные цены и скидки постоянным клиентам.
- Специальные условия для постоянных клиентов.
- Подбор аналогов.
- Поставку компонентов в любых объемах, удовлетворяющих вашим потребностям.
- Приемлемые сроки поставки, возможна ускоренная поставка.
- Доставку товара в любую точку России и стран СНГ.
- Комплексную поставку.
- Работу по проектам и поставку образцов.
- Формирование склада под заказчика.
- Сертификаты соответствия на поставляемую продукцию (по желанию клиента).
- Тестирование поставляемой продукции.
- Поставку компонентов, требующих военную и космическую приемку.
- Входной контроль качества.
- Наличие сертификата ISO.

В составе нашей компании организован Конструкторский отдел, призванный помогать разработчикам, и инженерам.

Конструкторский отдел помогает осуществить:

- Регистрацию проекта у производителя компонентов.
- Техническую поддержку проекта.
- Защиту от снятия компонента с производства.
- Оценку стоимости проекта по компонентам.
- Изготовление тестовой платы монтаж и пусконаладочные работы.



Тел: +7 (812) 336 43 04 (многоканальный)
Email: org@lifeelectronics.ru