

# CRD Series 10mm DIP Coded Rotary Switches

**Features/Benefits**

- Process sealed – withstands soldering and cleaning
- Thru-hole and surface mount models
- Crisp, positive detent ensures actuation
- Computer and peripherals
- RoHS compliant

**Typical Applications**

- Address switching applications
- Data storage devices
- Computer and peripherals
- Instrumentation

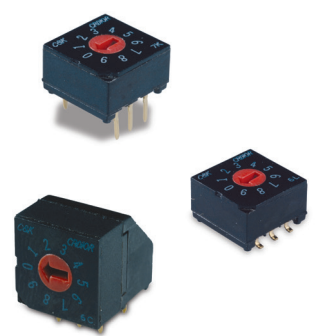

**Specifications**

CONTACT RATING: 0.4 V AC, DC 20 V max.  
 ELECTRICAL LIFE: 20,000 steps min. @ 5 V DC 10 mA.  
 MECHANICAL LIFE: 30,000 steps min.  
 CONTACT RESISTANCE: 100 milliohms max. initial @ 2 V DC 10 mA.  
 INSULATION RESISTANCE: 1000 megohms min. @ 100 V DC  
 DIELECTRIC STRENGTH: 300 V AC for 1 minute.  
 OPERATING TEMPERATURE: -20°C to 85°C.  
 STORAGE TEMPERATURE: -40°C to 85°C.  
 OPERATING FORCE: 1000 grams max.  
 PACKAGING: Switches supplied in anti-static tubes in full quantities only. This may affect order quantity. Surface mount models with M0 actuators available in tape and reel, 500 pieces per reel.

**Materials**

COVER: PPS (black)  
 HOUSING: PPS (black)  
 ACTUATOR: PA 6T M0 actuator option; PBT L1 and W1 actuator option.  
 CONTACTS: Beryllium Copper with Gold over Nickel plate  
 TERMINALS: Brass with Gold Nickel plate.

**Note:** Specifications and materials listed above are for switches with standard options. For information on specific and custom switches, consult Customer Service Center.

**How To Order**

The Build-A Switch concept allows you to mix and match options to create the switch you need. Below is a complete listing of options shown in catalog. To order, simply select desired option from each category and place in the appropriate box.

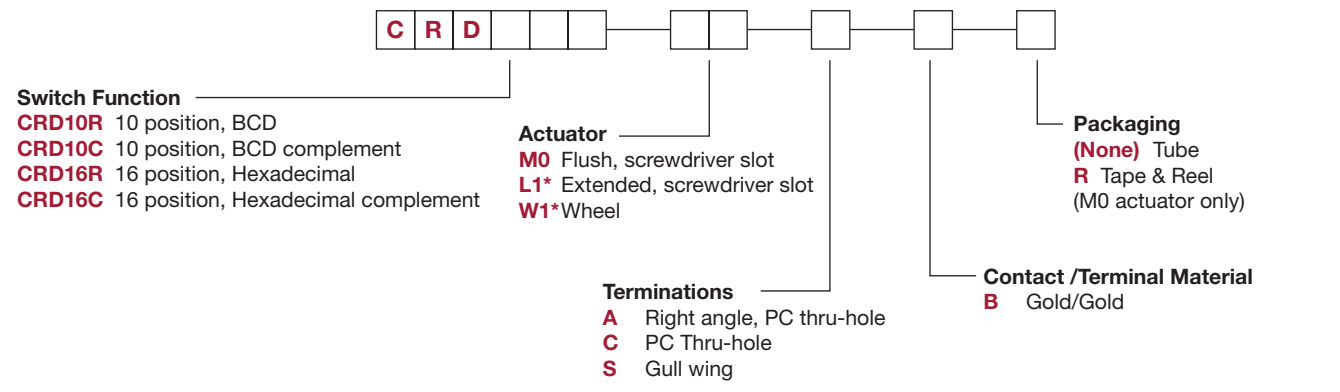

\* Note - L1 and W1 actuators are not available in termination “S”

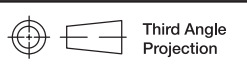

Dimensions are shown: Inch (mm)  
 Specifications and dimensions subject to change



# CRD Series 10mm DIP Coded Rotary Switches

## SWITCHES WITH STANDARD OPTIONS

### PC Mount

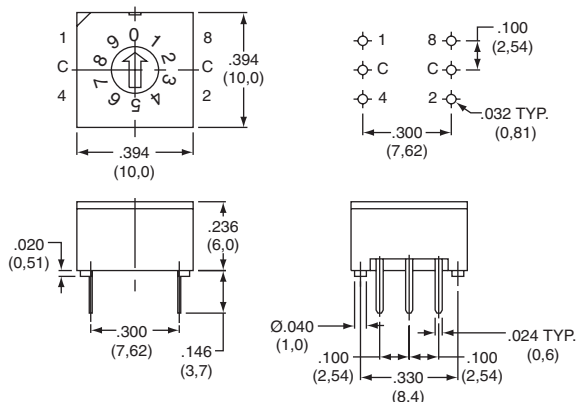
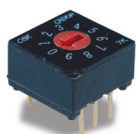

PART NUMBER	NO. POS.	QUANTITY PER TUBE
<b>CRD10RM0CB</b>	10	45
<b>CRD16RM0CB</b>	16	45

### Right Angle Mount

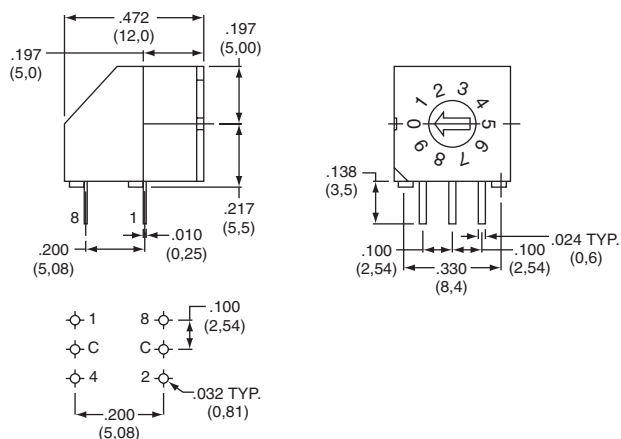

PART NUMBER	NO. POS.	QUANTITY PER TUBE
<b>CRD10RM0AB</b>	10	45
<b>CRD16RM0AB</b>	16	45

### Surface Mount

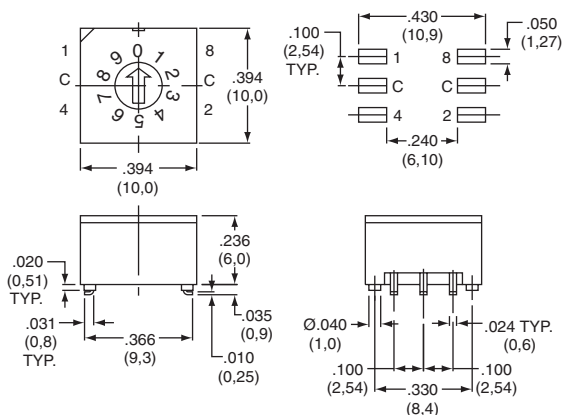

PART NUMBER	NO. POS.	QUANTITY PER TUBE
<b>CRD10RM0SB</b>	10	45
<b>CRD16RM0SB</b>	16	45

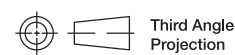

Dimensions are shown: Inch (mm)  
Specifications and dimensions subject to change

# CRD Series 10mm DIP Coded Rotary Switches

## SWITCH FUNCTION

### CRD10R

10 POSITION, BCD  
ACTUATOR COLOR: RED

POS.	0	1	2	3	4	5	6	7	8	9
C	●	●	●	●	●	●	●	●	●	●
1		●		●		●		●		●
2			●		●			●		●
4				●	●	●	●			
8									●	●

Switches ship and to be solder processed in position "0"

### CRD10C

10 POSITION, BCD COMPLEMENT  
ACTUATOR COLOR: ORANGE

POS.	0	1	2	3	4	5	6	7	8	9
C	●	●	●	●	●	●	●	●	●	●
1	●	●	●	●	●	●	●	●	●	●
2	●	●	●	●	●	●	●	●	●	●
4	●	●	●	●	●	●	●	●	●	●
8	●	●	●	●	●	●	●	●	●	●

Switches ship and to be solder processed in position "7"

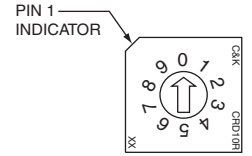

### CRD16R

16 POSITION, HEXADECIMAL  
ACTUATOR COLOR: BLACK

POS.	0	1	2	3	4	5	6	7	8	9	A	B	C	D	E	F
C	●	●	●	●	●	●	●	●	●	●	●	●	●	●	●	●
1	●	●	●	●	●	●	●	●	●	●	●	●	●	●	●	●
2		●	●	●		●		●		●		●		●		●
4				●	●	●						●	●	●		
8									●	●	●	●	●	●	●	●

Switches ship and to be solder processed in position "0"

### CRD16C

16 POSITION, HEXADECIMAL COMPLEMENT  
ACTUATOR COLOR: WHITE

POS.	0	1	2	3	4	5	6	7	8	9	A	B	C	D	E	F
C	●	●	●	●	●	●	●	●	●	●	●	●	●	●	●	●
1	●	●	●	●	●	●	●	●	●	●	●	●	●	●	●	●
2	●	●	●	●	●	●	●	●	●	●	●	●	●	●	●	●
4	●	●	●	●	●	●	●	●	●	●	●	●	●	●	●	●
8	●	●	●	●	●	●	●	●	●	●	●	●	●	●	●	●

Switches ship and to be solder processed in position "F"

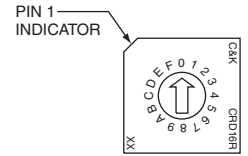

## ACTUATOR

(STD.) FLUSH WITH SCREWDRIVER SLOT

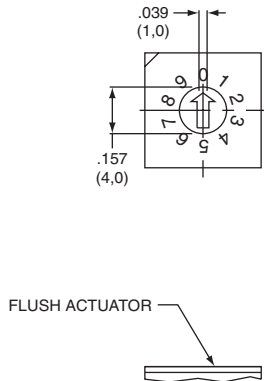

### L1\*

EXTENDED WITH SCREWDRIVER SLOT

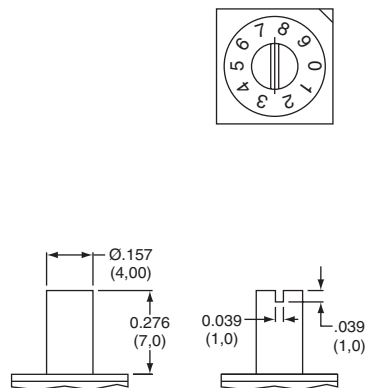

### W1\*

WHEEL

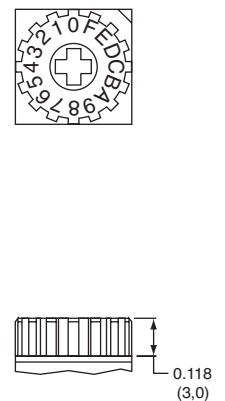

**NOTE:** Designed for #0 Phillips screwdriver.

\* L1 and W1 actuators are not available in termination "S"



Dimensions are shown: Inch (mm)  
Specifications and dimensions subject to change

# CRD Series 10mm DIP Coded Rotary Switches

## TERMINATIONS



DIP I

### C PC, THRU-HOLE

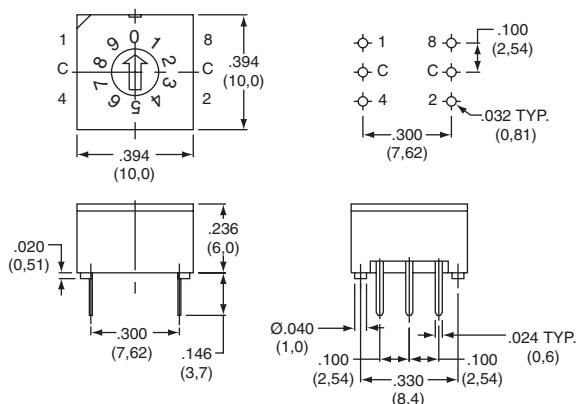

### A RIGHT ANGLE, PC THRU-HOLE

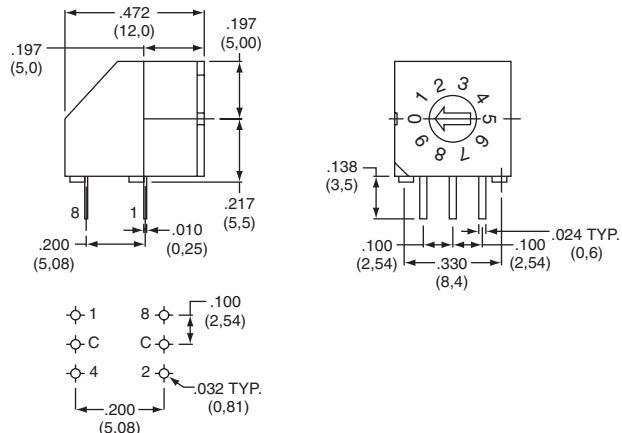

### S SURFACE MOUNT

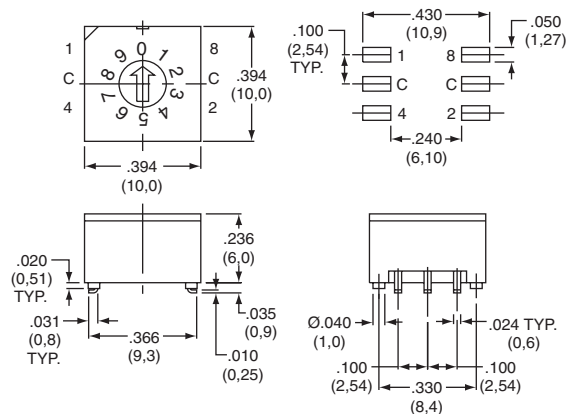

### MO

## CONTACT MATERIAL



OPTION CODE	RoHS COMPLIANT*	RoHS COMPATIBLE*	CONTACT MATERIAL	TERMINAL PLATING	RATING	
<b>B</b>	YES	YES	GOLD	GOLD	LOW LEVEL/DRY CIRCUIT	0.4 VC MAX. @ 20 V AC or DC MAX.

\* Note: See Technical Data section of this catalog for RoHS compliant and compatible definitions and specifications.

## TAPE & REEL

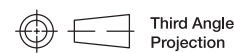
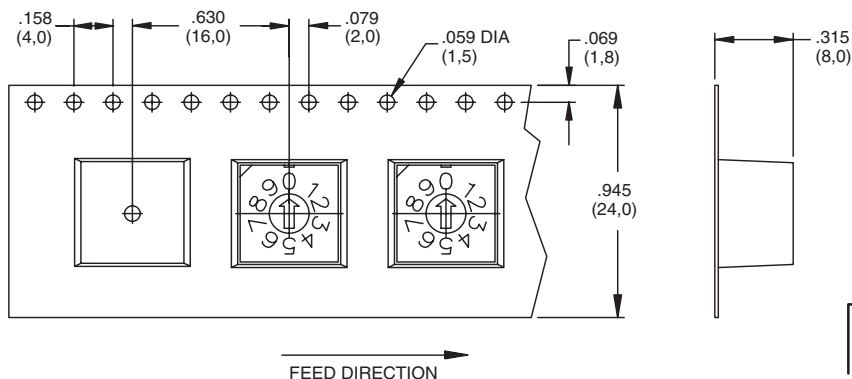

Dimensions are shown: Inch (mm)  
Specifications and dimensions subject to change

Компания «Life Electronics» занимается поставками электронных компонентов импортного и отечественного производства от производителей и со складов крупных дистрибьюторов Европы, Америки и Азии.

С конца 2013 года компания активно расширяет линейку поставок компонентов по направлению коаксиальный кабель, кварцевые генераторы и конденсаторы (керамические, пленочные, электролитические), за счёт заключения дистрибьюторских договоров

Мы предлагаем:

- Конкурентоспособные цены и скидки постоянным клиентам.
- Специальные условия для постоянных клиентов.
- Подбор аналогов.
- Поставку компонентов в любых объемах, удовлетворяющих вашим потребностям.
- Приемлемые сроки поставки, возможна ускоренная поставка.
- Доставку товара в любую точку России и стран СНГ.
- Комплексную поставку.
- Работу по проектам и поставку образцов.
- Формирование склада под заказчика.
- Сертификаты соответствия на поставляемую продукцию (по желанию клиента).
- Тестирование поставляемой продукции.
- Поставку компонентов, требующих военную и космическую приемку.
- Входной контроль качества.
- Наличие сертификата ISO.

В составе нашей компании организован Конструкторский отдел, призванный помогать разработчикам, и инженерам.

Конструкторский отдел помогает осуществить:

- Регистрацию проекта у производителя компонентов.
- Техническую поддержку проекта.
- Защиту от снятия компонента с производства.
- Оценку стоимости проекта по компонентам.
- Изготовление тестовой платы монтаж и пусконаладочные работы.



Тел: +7 (812) 336 43 04 (многоканальный)

Email: org@lifeelectronics.ru