

ADM6326/ADM6328/ADM6346/ADM6348

FEATURES

- Ultralow supply current of 1 μA maximum (ADM6326/ADM6328)
- Accurate monitoring of 2.5 V, 3 V, 3.3 V, and 5 V rails
- Reset thresholds available in increments from 2.2 V to 4.63 V
- Glitch immunity from negative-going V_{CC} transients
- 2 reset output options
 - Push-pull $\overline{\text{RESET}}$ (ADM6326/ADM6346)
 - Open-drain $\overline{\text{RESET}}$ (ADM6328/ADM6348)
- Minimum reset timeout of 100 ms
- Operating temperature range of -40°C to $+85^{\circ}\text{C}$
- 3-lead SOT-23 package

APPLICATIONS

- Telecommunications
- Microprocessor systems
- Desktop and notebook computers
- Portable equipment

GENERAL DESCRIPTION

The ADM6326/ADM6328/ADM6346/ADM6348 devices provide low cost solutions for protecting sensitive circuitry, such as microprocessor and telecommunications circuitry.

With built-in glitch immunity, ultralow supply currents, and 24 reset threshold voltage options, the ADM6326/ADM6328/ADM6346/ADM6348 not only ensure that systems are immune to fast transients on V_{CC} , but also that the devices are suitable for monitoring a variety of supply voltages in low power, portable equipment.

These devices provide a reset output during power-up, power-down, and brownout conditions. On power-up, an internal timer holds $\overline{\text{RESET}}$ asserted for at least 100 ms. This holds the

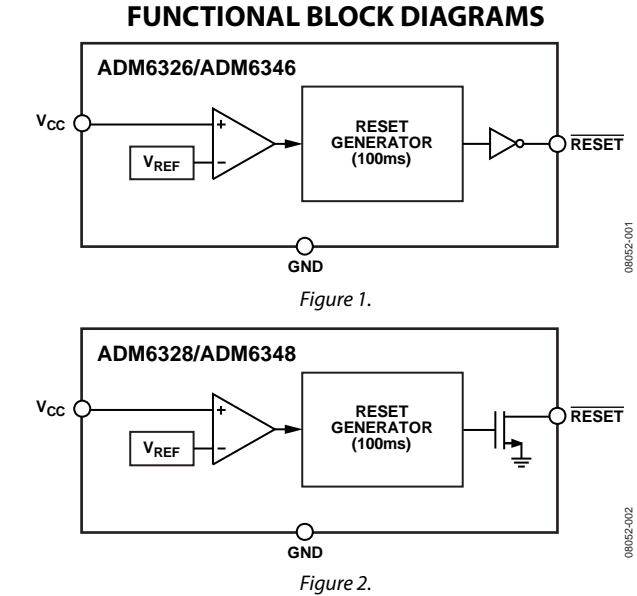

microprocessor in a reset state until conditions have stabilized. The reset output remains operational with V_{CC} as low as 1 V.

The ADM6326 and ADM6346 have an active low push-pull reset output. The ADM6328 and ADM6348 have an active low open-drain reset output, which requires an external pull-up resistor. The ADM6326 and ADM6328 offer a choice of ten reset thresholds in increments between 2.2 V and 3.08 V, whereas the ADM6346 and ADM6348 offer a choice of 14 reset thresholds between 3.3 V and 4.63 V.

These devices are available in a 3-lead SOT-23 package and operate over the extended temperature range of -40°C to $+85^{\circ}\text{C}$.

Rev. 0

Information furnished by Analog Devices is believed to be accurate and reliable. However, no responsibility is assumed by Analog Devices for its use, nor for any infringements of patents or other rights of third parties that may result from its use. Specifications subject to change without notice. No license is granted by implication or otherwise under any patent or patent rights of Analog Devices. Trademarks and registered trademarks are the property of their respective owners.

TABLE OF CONTENTS

Features	1	Pin Configuration and Function Descriptions.....	5
Applications.....	1	Typical Performance Characteristics	6
Functional Block Diagrams.....	1	Theory of Operation	7
General Description	1	Reset Output	7
Revision History	2	Interfacing to Other Devices	7
Specifications.....	3	Transient Immunity	7
Absolute Maximum Ratings.....	4	Outline Dimensions	8
Thermal Resistance	4	Ordering Guide	9
ESD Caution.....	4		

REVISION HISTORY

9/09—Revision 0: Initial Version

SPECIFICATIONS

$T_A = -40^{\circ}\text{C}$ to $+85^{\circ}\text{C}$, unless otherwise noted. Typical values are at $T_A = 25^{\circ}\text{C}$ and $V_{CC} = 3\text{ V}$. Overtemperature limits are guaranteed by design.

Table 1.

Parameter	Min	Typ	Max	Unit	Test Conditions/Comments
OPERATING VOLTAGE RANGE, V_{CC}	1.0		5.5	V	
INPUT CURRENT, I_{CC}		0.5	1.0	μA	ADM6326/ADM6328 only, $V_{CC} = 3.0\text{ V}$ for $V_{TH} \leq 2.93\text{ V}$, $V_{CC} = 3.2\text{ V}$ for $V_{TH} > 2.93\text{ V}$, no load
		1.0	1.75	μA	
RESET THRESHOLD					$T_A = 25^{\circ}\text{C}$
Threshold Voltage, V_{TH} (See Table 2)	$V_{TH} - 2.5\%$	V_{TH}	$V_{TH} + 2.5\%$	V	
	$V_{TH} - 1.5\%$	V_{TH}	$V_{TH} + 1.5\%$	V	
Temperature Coefficient		40		ppm/ $^{\circ}\text{C}$	
Hysteresis				mV	
		6.3		mV	
		9.5		mV	
TIMING CHARACTERISTICS					
V_{CC} to Reset Delay (t_{RD})		20		μs	$V_{CC} = V_{TH}$ to $(V_{TH} - 100\text{ mV})$
Reset Active Timeout Period (t_{RP})	100	185	280	ms	
RESET OUTPUT VOLTAGE LOW, V_{OL}			0.3	V	$V_{CC} > 2.1\text{ V}$, $I_{SINK} = 1.6\text{ mA}$, reset asserted
			0.4	V	$V_{CC} \geq 1.2\text{ V}$, $I_{SINK} = 100\text{ }\mu\text{A}$, reset asserted
RESET OUTPUT VOLTAGE HIGH, V_{OH}	$0.8 \times V_{CC}$			V	ADM6326 only, $V_{CC} = 3.2\text{ V}$, $I_{SOURCE} = 500\text{ }\mu\text{A}$
	$0.8 \times V_{CC}$			V	ADM6326/ADM6346 only, $V_{CC} = 4.5\text{ V}$, $I_{SOURCE} = 800\text{ }\mu\text{A}$, $V_{TH} \leq 4.38\text{ V}$
	$0.8 \times V_{CC}$			V	ADM6326/ADM6346 only, $V_{CC} = V_{TH(MAX)}$, $I_{SOURCE} = 800\text{ }\mu\text{A}$, $V_{TH} \geq 4.5\text{ V}$
OPEN-DRAIN RESET OUTPUT LEAKAGE CURRENT			0.1	μA	

Table 2. Reset Threshold Voltage

Parameter	$T_A = 25^{\circ}\text{C}$			$T_A = -40^{\circ}\text{C}$ to $+85^{\circ}\text{C}$		Unit
	Min	Typ	Max	Min	Max	
RESET THRESHOLD VOLTAGE (V_{TH})						
ADM632x-22	2.167	2.2	2.233	2.145	2.25	V
ADM632x-23	2.285	2.32	2.355	2.262	2.375	V
ADM632x-24	2.364	2.4	2.436	2.34	2.46	V
ADM632x-25	2.462	2.5	2.537	2.437	2.562	V
ADM632x-26	2.591	2.63	2.669	2.564	2.696	V
ADM632x-27	2.66	2.7	2.741	2.633	2.768	V
ADM632x-28	2.758	2.8	2.842	2.73	2.87	V
ADM632x-29	2.886	2.93	2.974	2.857	3.0	V
ADM632x-30	2.955	3.00	3.045	2.925	3.075	V
ADM632x-31	3.034	3.08	3.126	3.003	3.15	V
ADM634x-33	3.25	3.3	3.35	3.217	3.383	V
ADM634x-34	3.349	3.4	3.451	3.315	3.485	V
ADM634x-35	3.447	3.5	3.552	3.412	3.587	V
ADM634x-36	3.546	3.6	3.654	3.51	3.69	V
ADM634x-37	3.644	3.7	3.755	3.607	3.792	V
ADM634x-38	3.743	3.8	3.857	3.705	3.895	V
ADM634x-39	3.841	3.9	3.958	3.802	3.997	V
ADM634x-40	3.94	4.0	4.06	3.9	4.1	V
ADM634x-41	4.038	4.1	4.161	3.997	4.202	V
ADM634x-42	4.137	4.2	4.263	4.095	4.305	V
ADM634x-43	4.235	4.3	4.364	4.192	4.407	V
ADM634x-44	4.314	4.38	4.446	4.27	4.489	V
ADM634x-45	4.432	4.5	4.567	4.387	4.612	V
ADM634x-46	4.56	4.63	4.699	4.514	4.746	V

ABSOLUTE MAXIMUM RATINGS

Table 3.

Parameter	Rating
Supply Voltage, V_{CC}	-0.3 V to +6 V
Input Current, I_{CC}	20 mA
Output Voltage	
Push-Pull \overline{RESET}	-0.3 V to ($V_{CC} + 0.3$ V)
Open-Drain \overline{RESET}	-0.3 V to +6 V
Output Current (\overline{RESET})	20 mA
Rate of Rise of V_{CC}	100 V/ μ s
Temperature	
Storage	-65°C to +155°C
Operating	-40°C to +85°C
Soldering (10 sec)	300°C

Stresses above those listed under Absolute Maximum Ratings may cause permanent damage to the device. This is a stress rating only; functional operation of the device at these or any other conditions above those indicated in the operational section of this specification is not implied. Exposure to absolute maximum rating conditions for extended periods may affect device reliability.

THERMAL RESISTANCE

θ_{JA} is specified for the worst-case conditions, that is, a device soldered in a circuit board for surface-mount packages.

Table 4. Thermal Resistance

Package Type	θ_{JA}	Unit
3-Lead SOT-23	270	°C/W

ESD CAUTION



ESD (electrostatic discharge) sensitive device. Charged devices and circuit boards can discharge without detection. Although this product features patented or proprietary protection circuitry, damage may occur on devices subjected to high energy ESD. Therefore, proper ESD precautions should be taken to avoid performance degradation or loss of functionality.

PIN CONFIGURATION AND FUNCTION DESCRIPTIONS

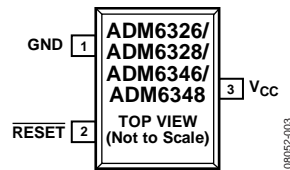

Figure 3. ADM6326/ADM6328/ADM6346/ADM6348 Pin Configuration

Table 5. Pin Function Descriptions

Pin No.	Mnemonic	Description
1	GND	Ground Reference for All Signals; 0 V.
2	<u>RESET</u>	Active Low Logic Output. This pin is low when V_{CC} is less than the reset threshold; it remains low for 185 ms (typical) after V_{CC} becomes greater than the reset threshold.
3	V_{CC}	Supply Voltage Being Monitored.

TYPICAL PERFORMANCE CHARACTERISTICS

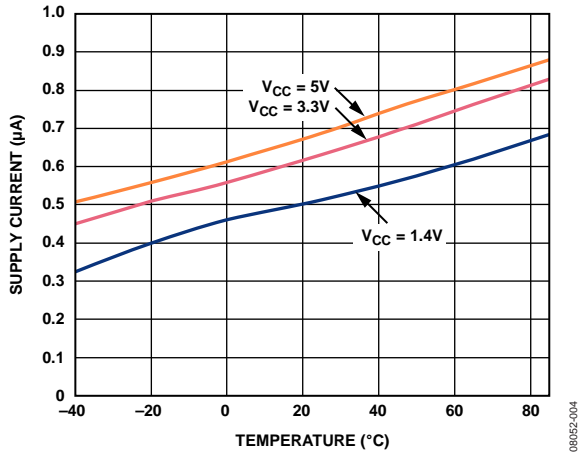

Figure 4. Supply Current vs. Temperature

08052-004

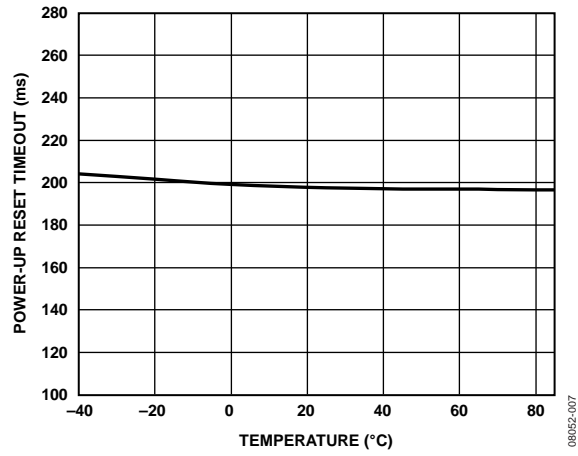

Figure 6. Power-Up Reset Timeout vs. Temperature

08052-007

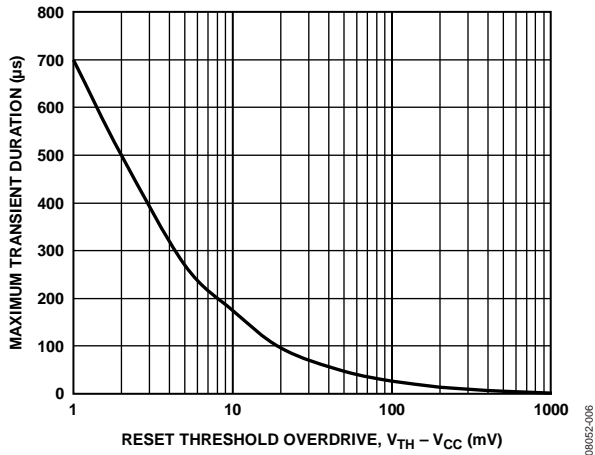

Figure 5. Maximum Transient Duration vs. Reset Threshold Overdrive

08052-008

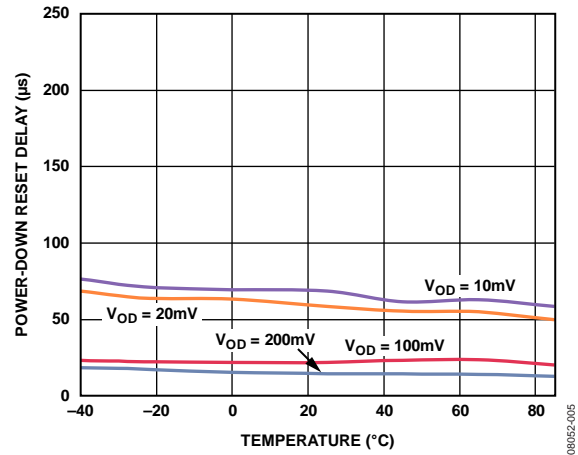

Figure 7. Power-Down Reset Delay vs. Temperature

08052-005

THEORY OF OPERATION

The ADM6326/ADM6328/ADM6346/ADM6348 are designed to protect the integrity of a system's operation by ensuring the proper operation of the system during power-up, power-down, and brownout conditions. Ultralow supply currents make these devices particularly suitable for use in low power, portable equipment.

RESET OUTPUT

The ADM6326 and ADM6346 have an active low, push-pull reset output, whereas the ADM6328 and ADM6348 have an active low, open-drain reset output, which requires an external pull-up resistor. The RESET signal is guaranteed to be valid for V_{CC} down to 1 V.

When the ADM6326/ADM6328/ADM6346/ADM6348 are powered up, the RESET output remains low for a period typically equal to the RESET active timeout period of 185 ms. This feature allows adequate time for the system to power up correctly and for the power supply to stabilize before any devices are brought out of reset and are allowed to begin executing instructions. Initializing a system in this way provides a more reliable startup for microprocessor systems.

When the monitored voltage falls below its associated threshold (V_{TH}), RESET is asserted within 20 μ s (typical). Asserting RESET this quickly means that the entire system can be reset at once before any part of the system's voltage falls below its recommended operating voltage. This system reset can avoid dangerous and/or erroneous operation of a microprocessor based system.

INTERFACING TO OTHER DEVICES

The active low, open-drain reset output of the ADM6328 and ADM6348 makes these devices ideal for integration with devices such as microprocessors with bidirectional reset pins. Simply connect the RESET output of the ADM6328 or ADM6348 to the RESET input of the microprocessor using a single pull-up resistor to allow either device to initiate a system reset (see Figure 8).

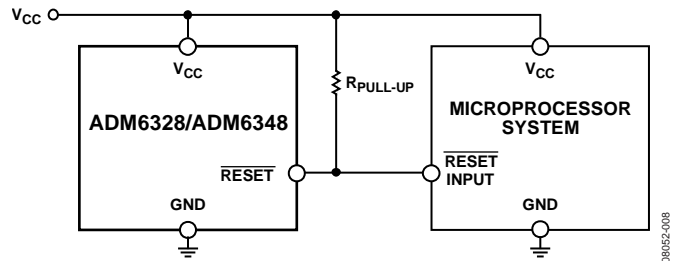

Figure 8. Interfacing to a Microprocessor with a Bidirectional Reset Pin

TRANSIENT IMMUNITY

To avoid unnecessary resets caused by fast power supply transients, the ADM6326/ADM6328/ADM6346/ADM6348 provide glitch immunity from negative-going V_{CC} transients.

Figure 5 shows the RESET comparator overdrive (that is, the maximum magnitude of negative-going pulses with respect to the typical threshold) vs. the pulse duration without a reset.

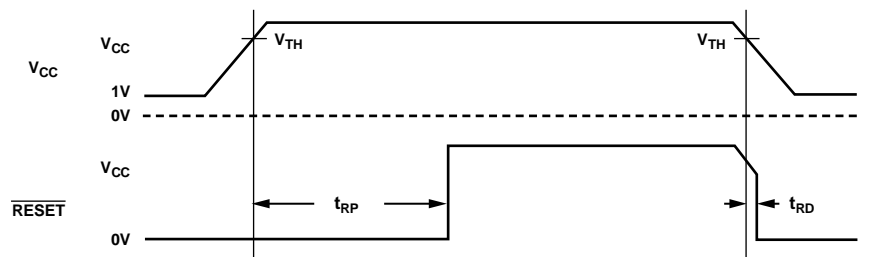
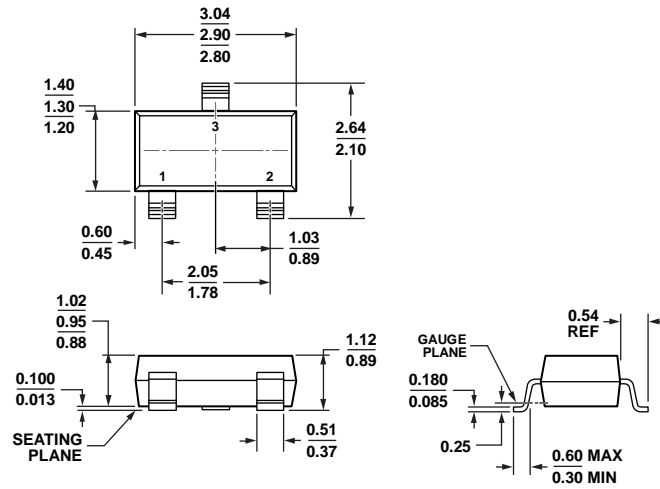

Figure 9. RESET Timing

OUTLINE DIMENSIONS



COMPLIANT TO JEDEC STANDARDS TO-236-AB

Figure 10. 3-Lead Small Outline Transistor Package [SOT-23-3] (RT-3)

Dimensions shown in millimeters

011909-C

ORDERING GUIDE

Model ¹	Typical Threshold Voltage (T _A = 25°C)	RESET Output Structure	Package Description	Package Option	Branding
ADM6326-22ARTZ-R7 ^{2, 3}	2.2 V	Push-Pull	3-Lead SOT-23	RT-3	LAQ
ADM6326-23ARTZ-R7 ²	2.32 V	Push-Pull	3-Lead SOT-23	RT-3	LAR
ADM6326-24ARTZ-R7 ²	2.4 V	Push-Pull	3-Lead SOT-23	RT-3	LAS
ADM6326-25ARTZ-R7 ²	2.5 V	Push-Pull	3-Lead SOT-23	RT-3	LAT
ADM6326-26ARTZ-R7 ²	2.63 V	Push-Pull	3-Lead SOT-23	RT-3	LAU
ADM6326-27ARTZ-R7 ²	2.7 V	Push-Pull	3-Lead SOT-23	RT-3	LAV
ADM6326-28ARTZ-R7 ²	2.8 V	Push-Pull	3-Lead SOT-23	RT-3	LAW
ADM6326-29ARTZ-R7 ²	2.93 V	Push-Pull	3-Lead SOT-23	RT-3	LAX
ADM6326-30ARTZ-R7 ²	3.0 V	Push-Pull	3-Lead SOT-23	RT-3	LAY
ADM6326-31ARTZ-R7 ²	3.08 V	Push-Pull	3-Lead SOT-23	RT-3	LAZ
ADM6328-22ARTZ-R7 ²	2.2 V	Open-Drain	3-Lead SOT-23	RT-3	LB0
ADM6328-23ARTZ-R7 ²	2.32 V	Open-Drain	3-Lead SOT-23	RT-3	LB1
ADM6328-24ARTZ-R7 ²	2.4 V	Open-Drain	3-Lead SOT-23	RT-3	LB2
ADM6328-25ARTZ-R7 ²	2.5 V	Open-Drain	3-Lead SOT-23	RT-3	LB3
ADM6328-26ARTZ-R7 ²	2.63 V	Open-Drain	3-Lead SOT-23	RT-3	LB4
ADM6328-27ARTZ-R7 ²	2.7 V	Open-Drain	3-Lead SOT-23	RT-3	LB5
ADM6328-28ARTZ-R7 ^{2, 3}	2.8 V	Open-Drain	3-Lead SOT-23	RT-3	LB6
ADM6328-29ARTZ-R7 ²	2.93 V	Open-Drain	3-Lead SOT-23	RT-3	LB7
ADM6328-30ARTZ-R7 ²	3.0 V	Open-Drain	3-Lead SOT-23	RT-3	LB8
ADM6328-31ARTZ-R7 ²	3.08 V	Open-Drain	3-Lead SOT-23	RT-3	LB9
ADM6346-33ARTZ-R7 ^{2, 3}	3.3 V	Push-Pull	3-Lead SOT-23	RT-3	LBA
ADM6346-34ARTZ-R7 ²	3.4 V	Push-Pull	3-Lead SOT-23	RT-3	LBC
ADM6346-35ARTZ-R7 ²	3.5 V	Push-Pull	3-Lead SOT-23	RT-3	LBD
ADM6346-36ARTZ-R7 ²	3.6 V	Push-Pull	3-Lead SOT-23	RT-3	LBE
ADM6346-37ARTZ-R7 ²	3.7 V	Push-Pull	3-Lead SOT-23	RT-3	LBF
ADM6346-38ARTZ-R7 ²	3.8 V	Push-Pull	3-Lead SOT-23	RT-3	LBG
ADM6346-39ARTZ-R7 ²	3.9 V	Push-Pull	3-Lead SOT-23	RT-3	LBH
ADM6346-40ARTZ-R7 ²	3.0 V	Push-Pull	3-Lead SOT-23	RT-3	LCN
ADM6346-41ARTZ-R7 ²	4.1 V	Push-Pull	3-Lead SOT-23	RT-3	LCP
ADM6346-42ARTZ-R7 ²	4.2 V	Push-Pull	3-Lead SOT-23	RT-3	LCQ
ADM6346-43ARTZ-R7 ²	4.3 V	Push-Pull	3-Lead SOT-23	RT-3	LCR
ADM6346-44ARTZ-R7 ²	4.38 V	Push-Pull	3-Lead SOT-23	RT-3	LCS
ADM6346-45ARTZ-R7 ²	4.5 V	Push-Pull	3-Lead SOT-23	RT-3	LCT
ADM6346-46ARTZ-R7 ²	4.63 V	Push-Pull	3-Lead SOT-23	RT-3	LCU
ADM6348-33ARTZ-R7 ²	3.3 V	Open-Drain	3-Lead SOT-23	RT-3	LCV
ADM6348-34ARTZ-R7 ²	3.4 V	Open-Drain	3-Lead SOT-23	RT-3	LCW
ADM6348-35ARTZ-R7 ²	3.5 V	Open-Drain	3-Lead SOT-23	RT-3	LCX
ADM6348-36ARTZ-R7 ²	3.6 V	Open-Drain	3-Lead SOT-23	RT-3	LCY
ADM6348-37ARTZ-R7 ²	3.7 V	Open-Drain	3-Lead SOT-23	RT-3	LCZ
ADM6348-38ARTZ-R7 ²	3.8 V	Open-Drain	3-Lead SOT-23	RT-3	LD0
ADM6348-39ARTZ-R7 ²	3.9 V	Open-Drain	3-Lead SOT-23	RT-3	LD1
ADM6348-40ARTZ-R7 ²	3.0 V	Open-Drain	3-Lead SOT-23	RT-3	LD2
ADM6348-41ARTZ-R7 ²	4.1 V	Open-Drain	3-Lead SOT-23	RT-3	LD3
ADM6348-42ARTZ-R7 ²	4.2 V	Open-Drain	3-Lead SOT-23	RT-3	LD4
ADM6348-43ARTZ-R7 ²	4.3 V	Open-Drain	3-Lead SOT-23	RT-3	LD5
ADM6348-44ARTZ-R7 ²	4.38 V	Open-Drain	3-Lead SOT-23	RT-3	LD6
ADM6348-45ARTZ-R7 ²	4.5 V	Open-Drain	3-Lead SOT-23	RT-3	LD7
ADM6348-46ARTZ-R7 ^{2, 3}	4.63 V	Open-Drain	3-Lead SOT-23	RT-3	LD8

¹ Contact sales for the availability of nonstandard models.

² Z = RoHS Compliant Part.

³ Standard model.

NOTES

NOTES

NOTES

Компания «Life Electronics» занимается поставками электронных компонентов импортного и отечественного производства от производителей и со складов крупных дистрибьюторов Европы, Америки и Азии.

С конца 2013 года компания активно расширяет линейку поставок компонентов по направлению коаксиальный кабель, кварцевые генераторы и конденсаторы (керамические, пленочные, электролитические), за счёт заключения дистрибьюторских договоров

Мы предлагаем:

- Конкурентоспособные цены и скидки постоянным клиентам.
- Специальные условия для постоянных клиентов.
- Подбор аналогов.
- Поставку компонентов в любых объемах, удовлетворяющих вашим потребностям.
- Приемлемые сроки поставки, возможна ускоренная поставка.
- Доставку товара в любую точку России и стран СНГ.
- Комплексную поставку.
- Работу по проектам и поставку образцов.
- Формирование склада под заказчика.
- Сертификаты соответствия на поставляемую продукцию (по желанию клиента).
- Тестирование поставляемой продукции.
- Поставку компонентов, требующих военную и космическую приемку.
- Входной контроль качества.
- Наличие сертификата ISO.

В составе нашей компании организован Конструкторский отдел, призванный помогать разработчикам, и инженерам.

Конструкторский отдел помогает осуществить:

- Регистрацию проекта у производителя компонентов.
- Техническую поддержку проекта.
- Защиту от снятия компонента с производства.
- Оценку стоимости проекта по компонентам.
- Изготовление тестовой платы монтаж и пусконаладочные работы.



Тел: +7 (812) 336 43 04 (многоканальный)

Email: org@lifeelectronics.ru