

General Purpose

Power Relay

SZR-LY Series

FEATURES

- Small package design
- ARC barrier equipped
- Silver Cadmium Oxide contact
- High dielectric strength (1,800 Vac)
- High reliability and long life
- Ultra-high sensitivity with quick response time (25 ms max.)
- High vibration and shock resistance
- Options include LED indicator, diode protection, and LED indicator/diode protection
- UL listed, CE certified, CSA certified

TYPICAL APPLICATIONS

- Control panels
- Elevator panels
- Machine tools
- Test equipment



SZR-LY Series general-purpose power relays are designed for a wide range of applications including power as well as logic control for factory machines and control panels.

SZR-LY Series relays break 10 A loads and are ideal for control panels that require stable and reliable relays.

One standard and three options are available: LED indicator, internal surge protection diode, and LED indicator/diode protection. Honeywell's global sales and distribution channels ensure a rapid response and excellent customer service.

⚠ WARNING

PERSONAL INJURY

DO NOT USE these products as safety or emergency stop devices or in any other application where failure of the product could result in personal injury.

Failure to comply with these instructions could result in death or serious injury.

⚠ WARNING

MISUSE OF DOCUMENTATION

- The information presented in this product sheet is for reference only. Do not use this document as a product installation guide.
- Complete installation, operation, and maintenance information is provided in the instructions supplied with each product.

Failure to comply with these instructions could result in death or serious injury.

General Purpose





Power Relays

SZR-LY Series

RELAY MODEL SELECTION GUIDE

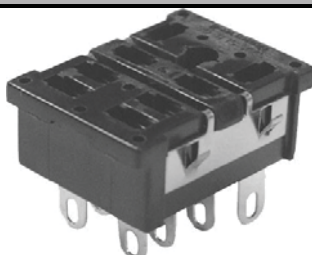
| Type | Terminal | Contact | Catalog Listing |
|-----------------------------------|----------------|---------|-------------------|
| Standard | Plug-in/Solder | DPDT | SZR-LY2-1 |
| | | 4PDT | SZR-LY4-1 |
| | PCB | DPDT | SZR-LY2-1P |
| | | 4PDT | SZR-LY4-1P |
| LED Indicator | Plug-in/Solder | DPDT | SZR-LY2-N1 |
| | | 4PDT | SZR-LY4-N1 |
| DIODE surge suppression | | DPDT | SZR-LY2-D1 |
| | | 4PDT | SZR-LY4-D1 |
| LED indicator + surge suppression | | DPDT | SZR-LY2-X1 |
| | | 4PDT | SZR-LY4-X1 |

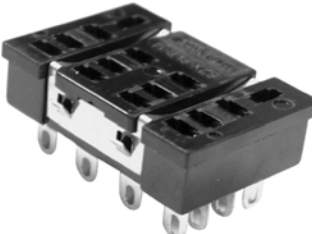
SOCKETS – REQUIRED ACCESSORIES

| Relay Contact | Din-rail Mounting | Solder Terminal | PCB Terminal |
|---|--|---|---|
| DPDT For use with SZR-LY2-1, - N1, -D1, -X1 |  SZX-SLF-08N |  SZX-SLB-08 |  SZX-SLB-08P |
| 4PDT For use with SZR-LY4-1, - N1, -D1, -X1 |  SZX-SLF-14 |  SZX-SLB-14 |  SZX-SLB-14P |

CONTACT RATINGS

| Ratings | Load | Resistive Load (p.f. = 1) | Inductive load (p.f. = 0.4, L/R = 7 ms) |
|-------------------------|------|-------------------------------|--|
| Rated load | | 110 Vac, 10 A 24 Vdc, 10 A | 110 Vac, 7.5 A 24 Vdc, 5 A |
| Carry current | | 10 A | |
| Max. operating voltage | | 250 Vac, 125 Vdc | |
| Max. operating current | | 10 A | |
| Max. switching capacity | | 1,100 VA, 240 W | 825 VA, 120 W |
| Min. permissible load | | 5 Vdc, 100 mA | |

General Purpose

Power Relays

SZR-LY Series

COIL RATINGS (DPDT)

| | Rated Voltage (V) | Rated Current (mA) | | Coil resistance (Ω) | Coil Inductance (H) | | Pick-up Voltage (V) | Dropout Voltage (V) | Maximum Voltage (V) | Power Consumption (W) |
|---------|-------------------|--------------------|---------|---------------------|---------------------|-------------|---------------------|---------------------|---------------------|--------------------------------------|
| | | 50 Hz | 60 Hz | | Armature OFF | Armature ON | | | | |
| AC | 6 | 214.1 | 183 | 12.2 | 0.04 | 0.08 | Max. 80 % | Min. 30% | 110% | Approx. 1.0 W to 1.2 W (60 Hz) |
| | 12 | 106.5 | 91 | 46 | 0.17 | 0.33 | | | | |
| | 24 | 53.8 | 46 | 180 | 0.69 | 1.3 | | | | |
| | 50 | 25.7 | 22 | 788 | 3.22 | 5.66 | | | | Approx. 0.9 W to 1.1 W (60 Hz) |
| | 100/110 | 11.7/12.9 | 10/11 | 3,750 | 14.54 | 24.6 | | | | |
| | 110/120 | 9.9/10.8 | 8.4/9.2 | 4,430 | 19.2 | 32.1 | | | | |
| | 200/220 | 6.2/6.8 | 5.3/5.8 | 12,950 | 54.75 | 94.07 | | | | |
| 220/240 | 4.8/5.3 | 4.2/4.6 | 18,790 | 83.5 | 136.4 | | | | | |
| DC | 6 | 150 | | 40 | 0.17 | 0.33 | Max. 80% | Min. 10% | 110% | Approx. 0.9 W |
| | 12 | 75 | | 160 | 0.73 | 1.37 | | | | |
| | 24 | 36.9 | | 650 | 3.2 | 5.72 | | | | |
| | 48 | 18.5 | | 2,600 | 10.6 | 21.0 | | | | |
| | 100/110 | 9.1/10 | | 11,000 | 45.6 | 86.2 | | | | |

COIL RATINGS (4PDT)

| | Rated Voltage (V) | Rated Current (mA) | | Coil resistance (Ω) | Coil Inductance (H) | | Pick-up Voltage (V) | Dropout Voltage (V) | Maximum Voltage (V) | Power Consumption (W) |
|----|-------------------|--------------------|----------|---------------------|---------------------|-------------|---------------------|---------------------|---------------------|---------------------------------------|
| | | 50 Hz | 60 Hz | | Armature OFF | Armature ON | | | | |
| AC | 6 | 386 | 330 | 5 | 0.02 | 0.04 | Max. 80 % | Min. 30% | 110% | Approx. 1.95 W to 2.5 W (60 Hz) |
| | 12 | 199 | 170 | 20 | 0.1 | 0.17 | | | | |
| | 24 | 93.6 | 80 | 78 | 0.38 | 0.67 | | | | |
| | 50 | 46.8 | 40 | 350 | 1.74 | 2.88 | | | | |
| | 100/110 | 22.5/25.5 | 19/21.8 | 1,800 | 10.5 | 17.3 | | | | |
| | 200/220 | 11.5/13.1 | 9.8/11.2 | 6,700 | 33.1 | 57.9 | | | | |
| DC | 6 | 240 | | 25 | 0.09 | 0.21 | Max. 80% | Min. 10% | 110% | Approx. 1.5 W |
| | 12 | 120 | | 100 | 0.39 | 0.84 | | | | |
| | 24 | 69 | | 350 | 1.41 | 2.91 | | | | |
| | 48 | 30 | | 1,600 | 6.39 | 13.6 | | | | |
| | 100/110 | 15/15.9 | | 6,900 | 32 | 63.7 | | | | |

Note 1: The rated current and coil resistance are measured at a coil temperature of 23 °C [73.4 °F] with tolerances of +15%, -20% for AC rated current and ± 15% for DC coil resistance.

Note 2: The rated current of N1 and X1 types is 4 mA higher than the value in the table above.

General Purpose

Power Relays

SZR-LY Series

SPECIFICATIONS

| | | |
|------------------------------|------------------------|--|
| Contact material | | Silver Cadium Oxide |
| Contact resistance | | Max. 50 MOhm |
| Operate time | | Max. 25 ms |
| Release time | | Max. 25 ms |
| Operating frequency | Mechanical | 18,000 operations per hour |
| | Electrical | 1,800 operations per hour |
| Insulation resistance | | Min. 100 Mw at 500 Vdc |
| Dielectric withstand voltage | | 1,800 Vac 50 Hz/60 Hz for one minute between non-continuous current carrying terminals and between coil terminals and contact terminals 1,000 Vac 50/60 Hz for 1 minute between contacts of same polarity |
| Vibration resistance | Mechanical durability | 10 Hz to 55 Hz at double amplitude of 1.0 mm |
| | Malfunction durability | 10 Hz to 55 Hz at double amplitude of 1.0 mm |
| Shock resistance | Mechanical durability | 1,000 m/s ² (approx. 100 g) |
| | Malfunction durability | 200 m/s ² (approx. 20 g) |
| Service life | Mechanical | AC: Min. 50 million operations (at operating frequency of 18,000 operations/hour) DC: Min. 100 million operations (at operating frequency of 18,000 operations/hour) |
| | Electrical | DPDT: Min. 500,000 operations (at operating frequency of 1,800 operations/hour) 4PDT: Min. 200,000 operations (at operating frequency of 1,800 operations/hour) |
| Weight | | DPDT: Approximately 35 g 4PDT: Approximately 65 g |

Note 1: The data shown above are of initial value

CHARACTERISTIC DATA

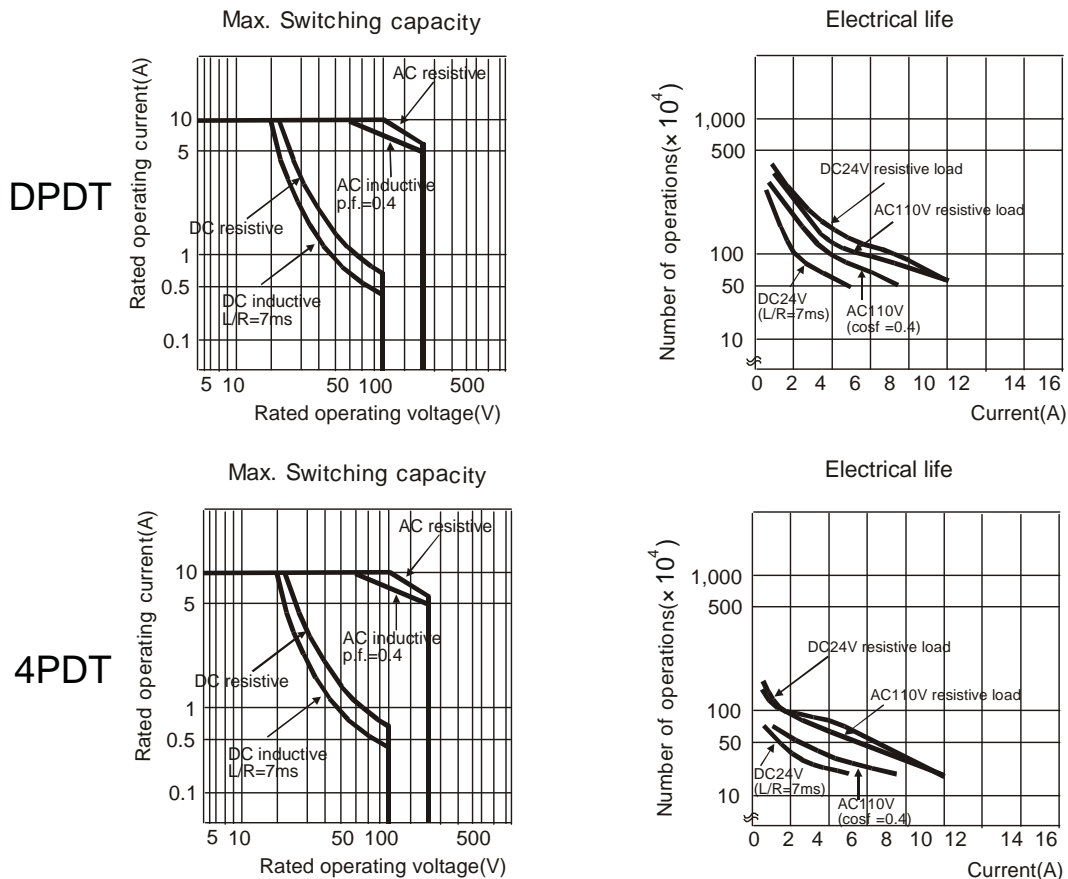

General Purpose

Power Relays

SZR-LY Series

CATALOG LISTING MATRIX

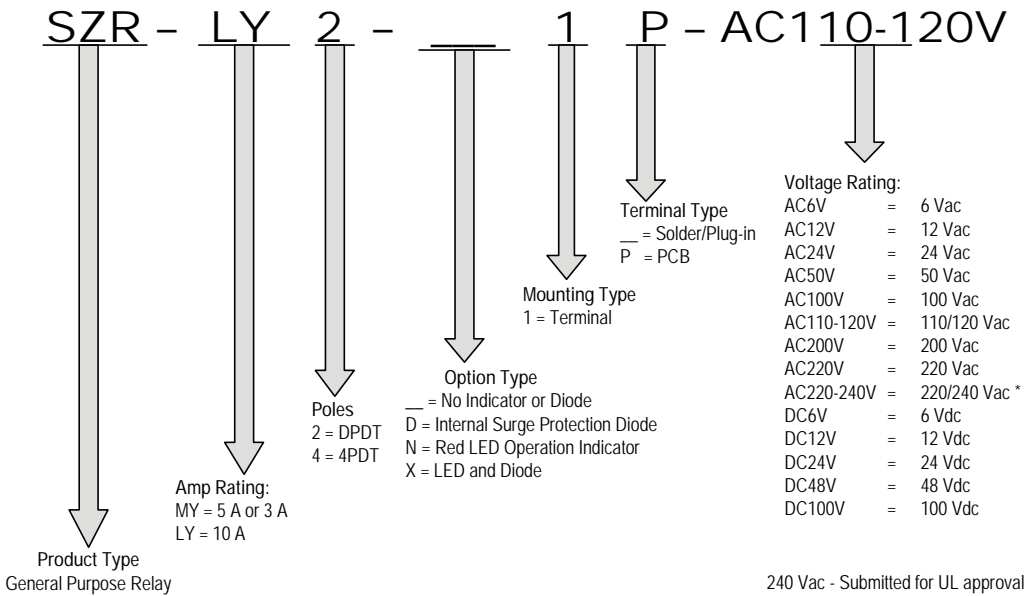

General Purpose

Power Relays

SZR-LY Series

HOLDING CLIPS

- Holding clips are included with the sockets
- Holding clips for the SLF-08N cannot be removed once inserted
- The holding clip for the SLF-14 can be removed by pushing the side of the inserting hold with a sharp object
- Holding clips for all SMB sockets are wire for easy removal
- Holding clips are to be inserted into the slots provided on the socket

DIMENSIONS (For reference only – mm/in)

Figure 1. Dimensions

For SZX-SLF-14 sockets

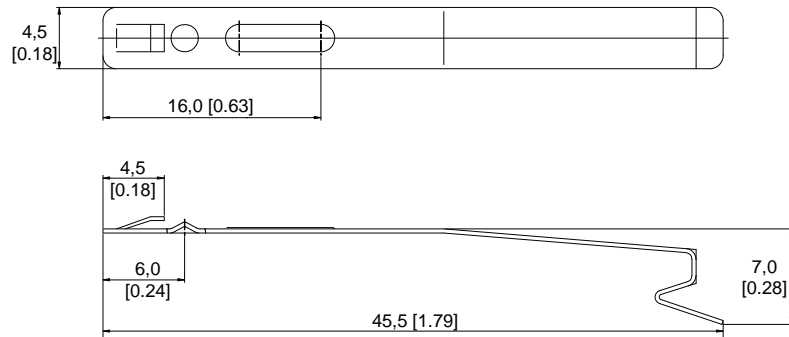

Figure 2. Dimensions

For SZX-SLF-08N sockets

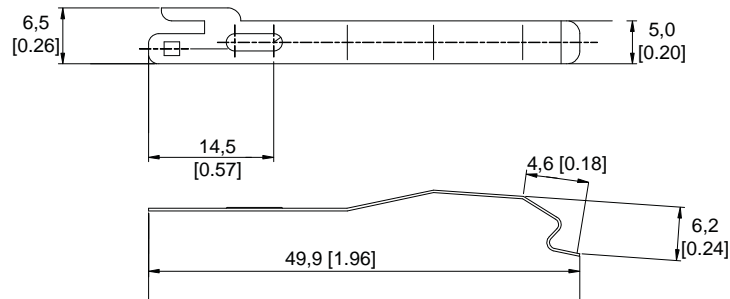
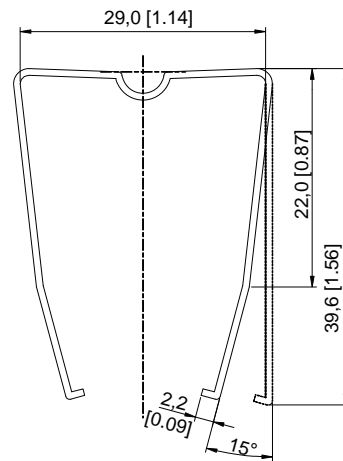

Figure 3. Dimensions

For all SZX-SLB sockets



General Purpose

Power Relays

SZR-LY Series

FIGURE 4. DIMENSION, CIRCUIT DIAGRAM, TERMINAL ARRANGEMENT, AND MOUNTING HOLE FOR SZR-LY2-1, SZR-LY2-N1, SZR-LY2-D1, and SZR-LY2-X1

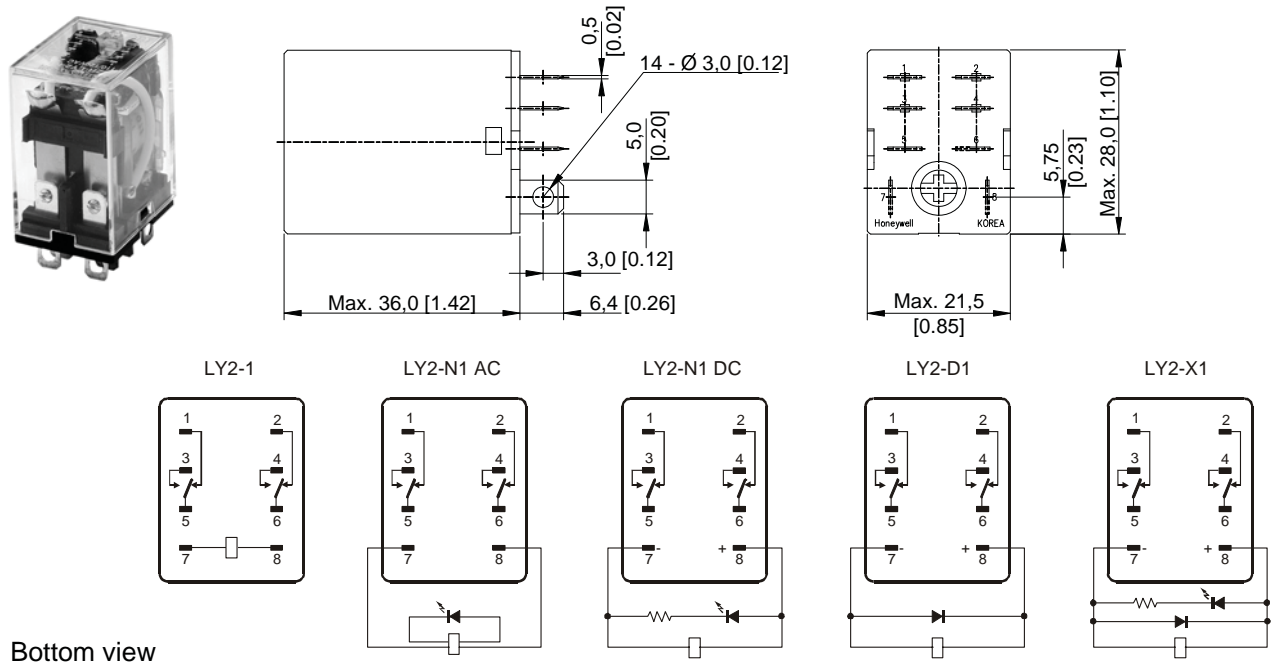

Bottom view

FIGURE 5. DIMENSION, CIRCUIT DIAGRAM, TERMINAL ARRANGEMENT, AND MOUNTING HOLE FOR SZR-MY2-1P and SZR-MY4-1P

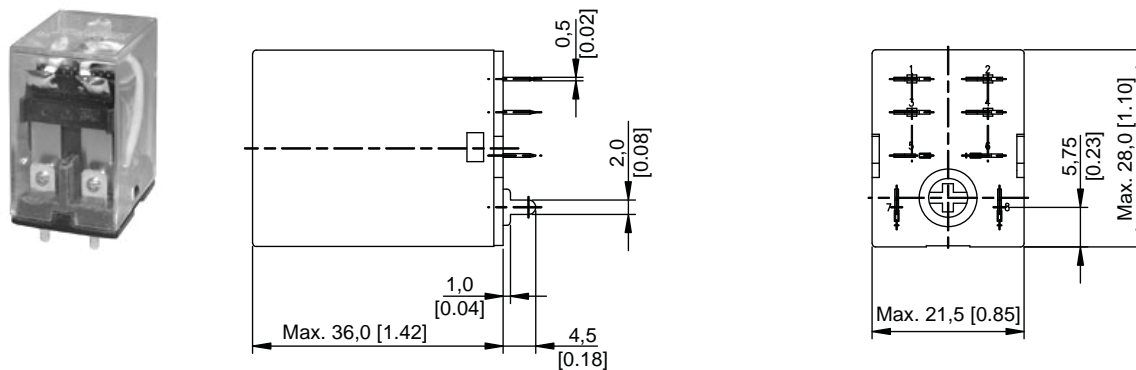

The circuit diagram is the same with standard type of SZR-MY2-1 or the SZR-MY4-1

General Purpose

Power Relays

SZR-LY Series

FIGURE 6. DIMENSION, CIRCUIT DIAGRAM, TERMINAL ARRANGEMENT, AND MOUNTING HOLE FOR SZR-LY4-1, SZR-LY4-N1, SZR-LY4-D1, and SZR-LY4-X1

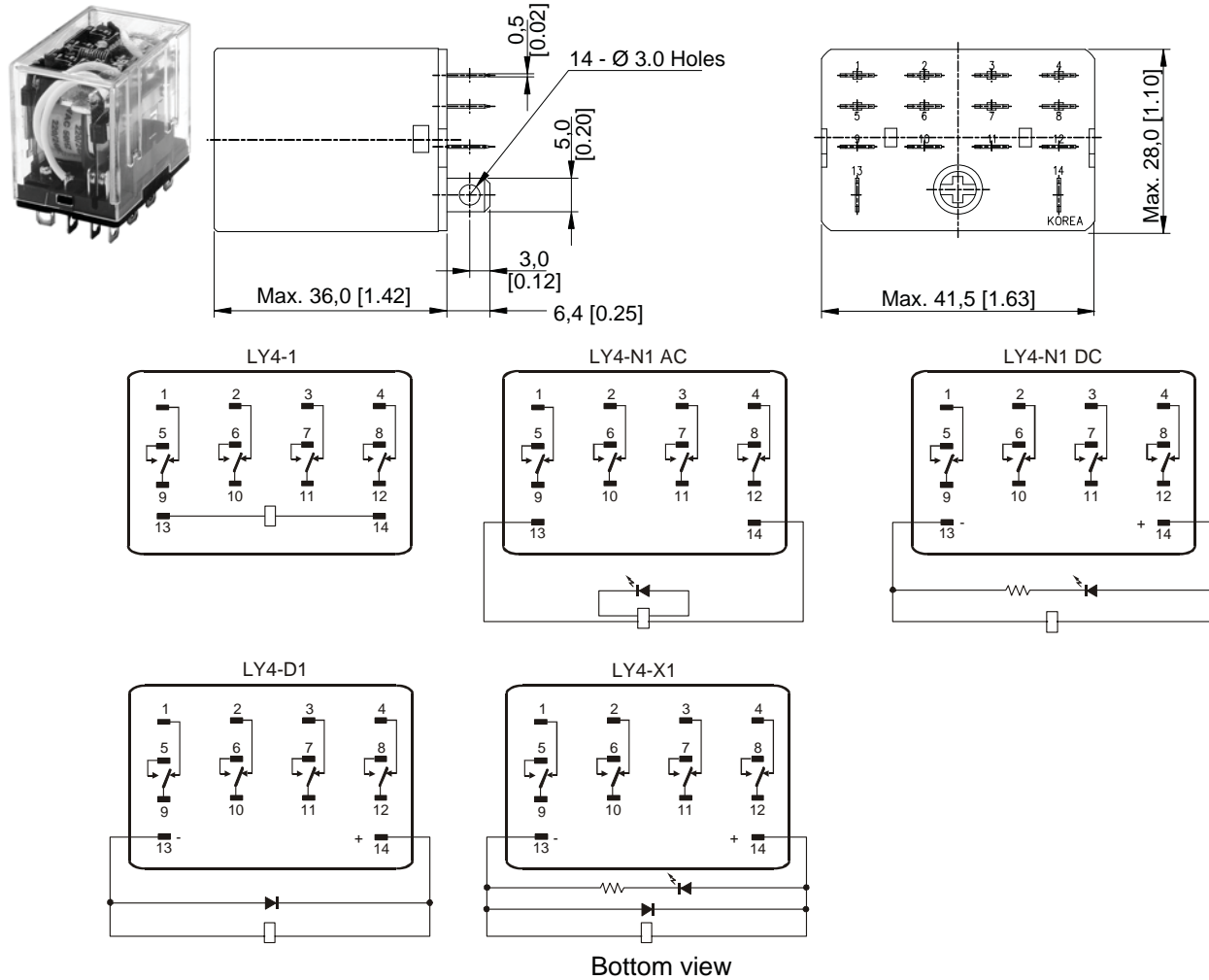
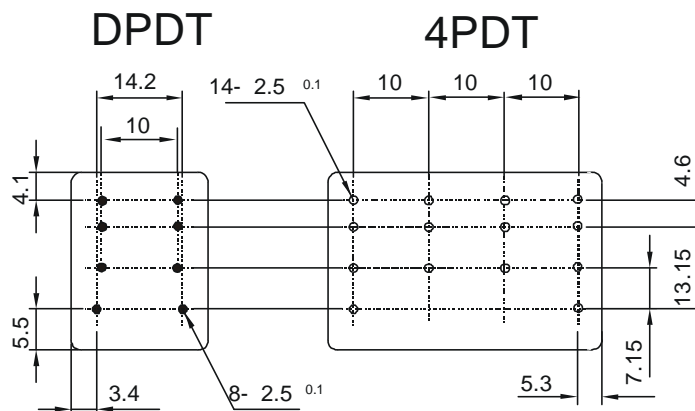

FIGURE 7. CIRCUIT DRAWING FOR SZR-LY2- and SZR-LY4-



General Purpose Power Relays

SZR-LY Series

SOCKETS

FIGURE 8. SZX-SLF-08N

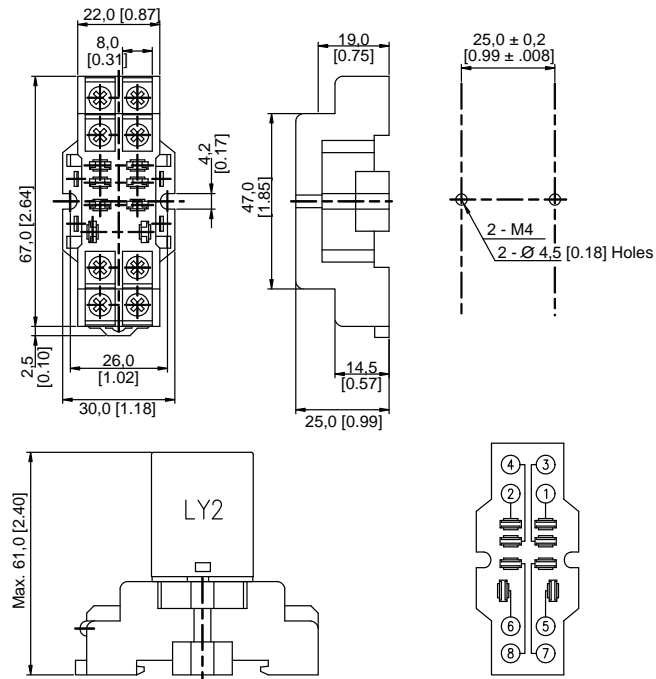

FIGURE 9. SZX-SLF-14

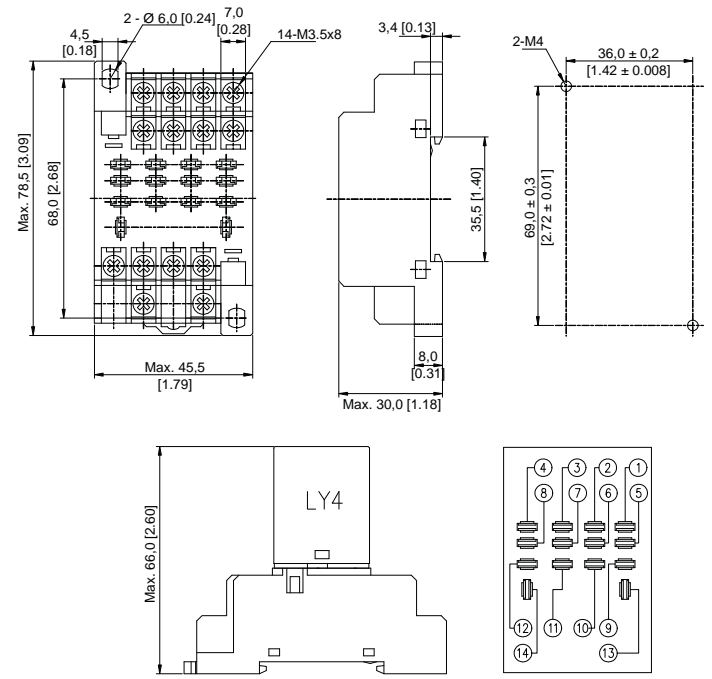

FIGURE 10. SZX-SLB-08

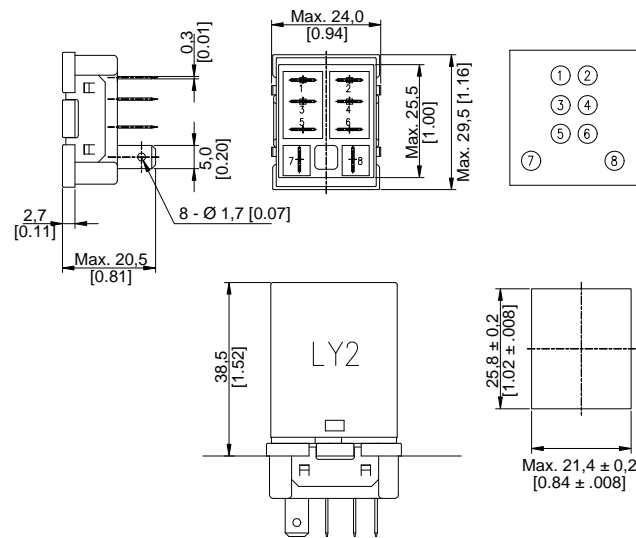
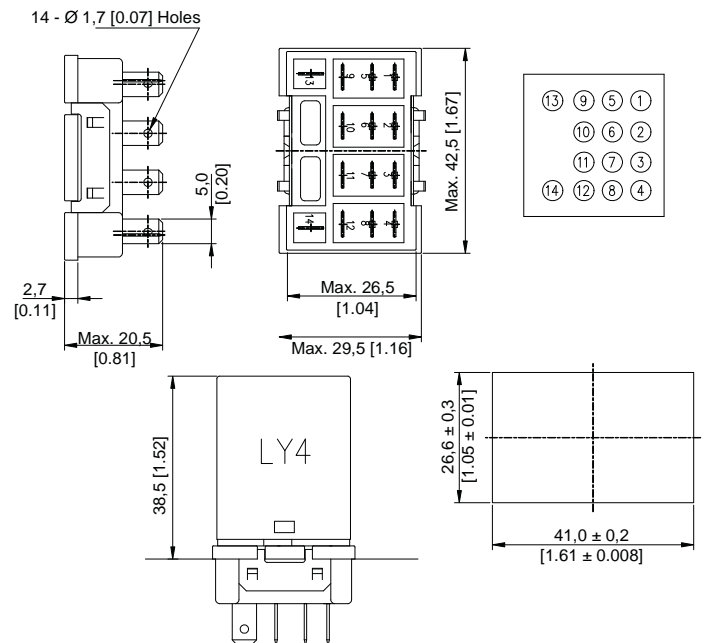

FIGURE 11. SZX-SLB-14



General Purpose

Power Relays

SZR-LY Series

FIGURE 12. SZX-SLB-08P

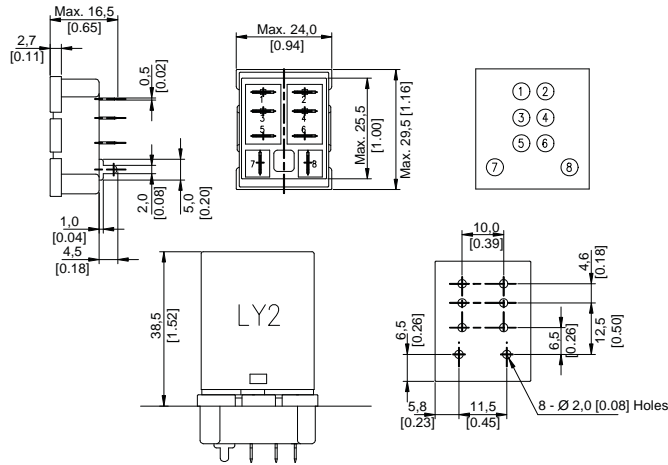
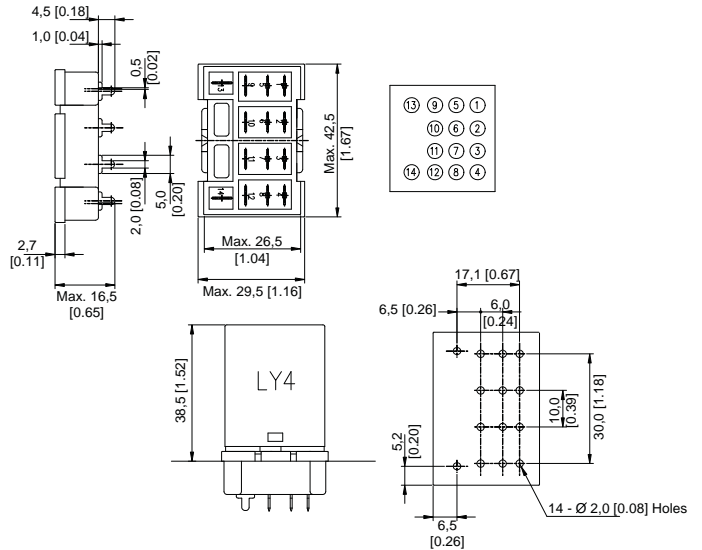

FIGURE 13. SZX-SLB-14P



WARRANTY/REMEDY

Honeywell warrants goods of its manufacture as being free of defective materials and faulty workmanship. Contact your local sales office for warranty information. If warranted goods are returned to Honeywell during the period of coverage, Honeywell will repair or replace without charge those items it finds defective. **The foregoing is Buyer's sole remedy and is in lieu of all other warranties, expressed or implied, including those of merchantability and fitness for a particular purpose.**

Specifications may change without notice. The information we supply is believed to be accurate and reliable as of this printing. However, we assume no responsibility for its use.

While we provide application assistance personally, through our literature and the Honeywell web site, it is up to the customer to determine the suitability of the product in the application.

For application assistance, current specifications, or name of the nearest Authorized Distributor, contact a nearby sales office. Or call:

1-800-537-6945 USA/Canada

1-815-235-6847 International

FAX

1-815-235-6545 USA

INTERNET

www.honeywell.com/sensing

info.sc@honeywell.com

Honeywell

Sensing and Control
www.honeywell.com/sensing

Honeywell
 11 West Spring Street
 Freeport, Illinois 61032

Компания «Life Electronics» занимается поставками электронных компонентов импортного и отечественного производства от производителей и со складов крупных дистрибьюторов Европы, Америки и Азии.

С конца 2013 года компания активно расширяет линейку поставок компонентов по направлению коаксиальный кабель, кварцевые генераторы и конденсаторы (керамические, пленочные, электролитические), за счёт заключения дистрибьюторских договоров

Мы предлагаем:

- Конкурентоспособные цены и скидки постоянным клиентам.
- Специальные условия для постоянных клиентов.
- Подбор аналогов.
- Поставку компонентов в любых объемах, удовлетворяющих вашим потребностям.
- Приемлемые сроки поставки, возможна ускоренная поставка.
- Доставку товара в любую точку России и стран СНГ.
- Комплексную поставку.
- Работу по проектам и поставку образцов.
- Формирование склада под заказчика.
- Сертификаты соответствия на поставляемую продукцию (по желанию клиента).
- Тестирование поставляемой продукции.
- Поставку компонентов, требующих военную и космическую приемку.
- Входной контроль качества.
- Наличие сертификата ISO.

В составе нашей компании организован Конструкторский отдел, призванный помогать разработчикам, и инженерам.

Конструкторский отдел помогает осуществить:

- Регистрацию проекта у производителя компонентов.
- Техническую поддержку проекта.
- Защиту от снятия компонента с производства.
- Оценку стоимости проекта по компонентам.
- Изготовление тестовой платы монтаж и пусконаладочные работы.



Тел: +7 (812) 336 43 04 (многоканальный)
Email: org@lifeelectronics.ru