

DESCRIPTION

The MP3318 is a WLED step-up converter with three current sinks and a 2.7 - 5.5V power supply input. The MP3318 uses peak-current mode to regulate the LED current set by the internal register.

The MP3318 integrates a 250mΩ, 42V MOSFET. The maximum LED voltage is up to 38V. The MP3318 is able to drive 10 LEDs in series for LCD panel applications larger than 5".

The MP3318 supports both linear and exponential analog dimming with 11-bit, ultra-high resolution to accurately regulate the dimming current. Its auto-switching frequency function can optimize the efficiency performance. Full protection features include LED open and short protection, cycle-by-cycle current-limit protection, and thermal shutdown.

The I²C interface can set the internal register to program the MP3318 for flexible applications, such as dimming mode, LED current ramp, and protection threshold.

The MP3318 is available in a tiny WLCSP-12 (1.3mmx1.7mm) package.

FEATURES

- 2.7V - 5.5V Input Voltage
- 42V, 250mΩ Internal MOSFET
- 3-Channel Current Sink, Each Channel Enable/Disable Respectively
- LED Current Up to 25mA in Backlighting Mode
- Linear or Exponential Analog Dimming
- LED Current Up to 50mA in Flash Mode
- 11-Bit Dimming Resolution
- Excellent LED Current Accuracy
- Excellent LED String Current Matching
- 500kHz/1MHz Switching Frequency with Optional -12% Shift
- Auto-Switching Frequency (250kHz, 500kHz, 1MHz)
- High-Speed I²C Interface (1.2MHz)
- Internal Soft Start to Reduce Inrush Current
- Current-Limit Protection (0.75A, 1A, 1.25A, 1.5A)
- LED Open Protection (17V, 23V, 30V, 38V)
- LED Short Protection (2V, 3V, 5V)
- Available in a WLCSP-12 (1.3mmx1.7mm) Package

APPLICATIONS

- Smartphones
- Tablets
- GPS Receivers
- LCD Video Displays with One-Cell Li-Ion Battery

All MPS parts are lead-free, halogen-free, and adhere to the RoHS directive. For MPS green status, please visit the MPS website under Quality Assurance. "MPS" and "The Future of Analog IC Technology" are registered trademarks of Monolithic Power Systems, Inc.

TYPICAL APPLICATION

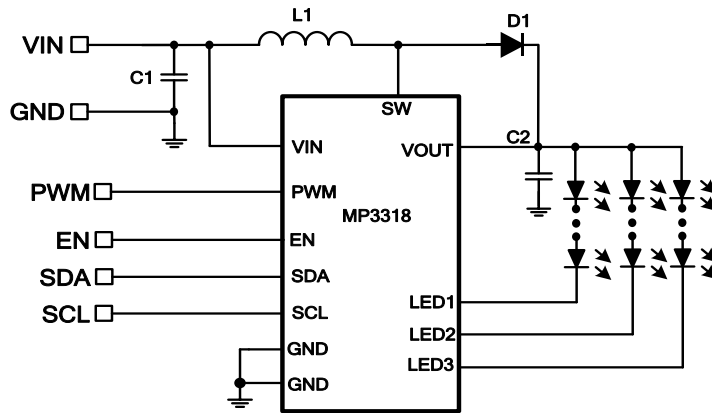

Efficiency vs. ILED

V_{IN} = 3.8V, 3P8S, 10μH, DCR = 280mΩ

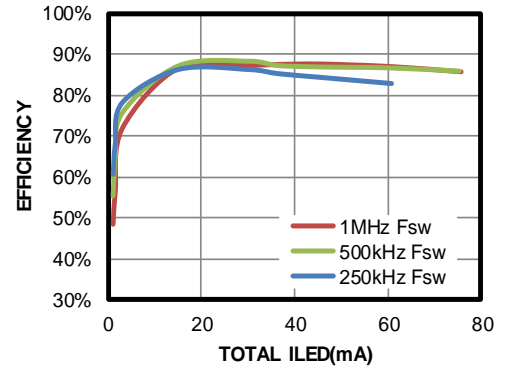

ORDERING INFORMATION

Part Number*	Package	Top Marking
MP3318GC	WLCSP-12 (1.3mmx1.7mm)	See Below

* For Tape & Reel, add suffix -Z (e.g. MP3318GC-Z)

TOP MARKING

───
FQY
LLL

FQ: Product code of MP3318GC
 Y: Year code
 LLL: Lot number

PACKAGE REFERENCE

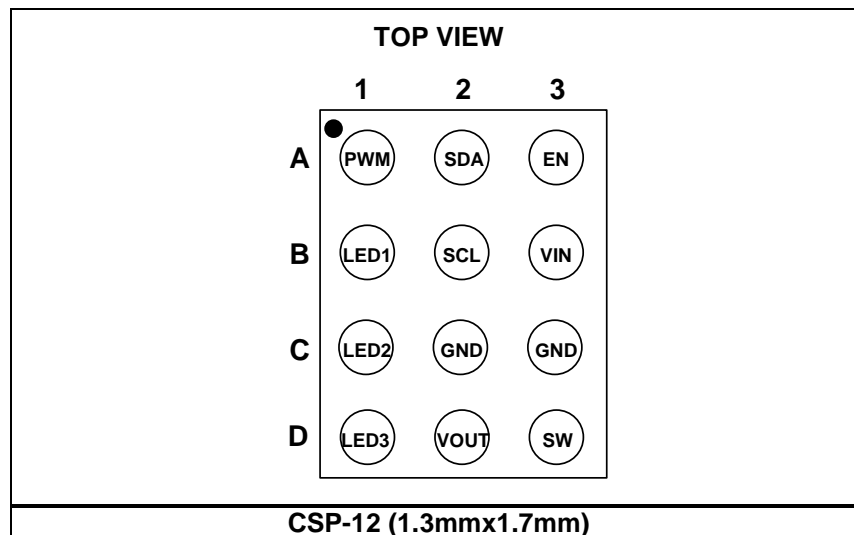

ABSOLUTE MAXIMUM RATINGS ⁽¹⁾

V _{IN}	-0.3V to +6V
V _{SW}	-1V to +42V
V _{LED1-3}	-0.3V to +40V
V _{OUT}	-1V to +40V
All other pins.....	-0.3V to +5.3V
Junction temperature	150°C
Lead temperature	260°C
Continuous power dissipation (T _A = 25°C) ⁽²⁾	
WLCSP12 (1.3mmx1.7mm)	1.14W

Recommended Operating Conditions ⁽³⁾

Supply voltage (V _{IN})	2.7V to 5.5V
Operating junction temp. (T _J) ..	-40°C to +125°C

Thermal Resistance ⁽⁴⁾ θ_{JA} θ_{JC}
 WLCSP-12 (1.3mmx1.7mm) ... 110 ... 12 ... °C/W

NOTES:

- Exceeding these ratings may damage the device.
- The maximum allowable power dissipation is a function of the maximum junction temperature T_J (MAX), the junction-to-ambient thermal resistance θ_{JA}, and the ambient temperature T_A. The maximum allowable continuous power dissipation at any ambient temperature is calculated by P_D (MAX) = (T_J (MAX)-T_A)/θ_{JA}. Exceeding the maximum allowable power dissipation produces an excessive die temperature, causing the regulator to go into thermal shutdown. Internal thermal shutdown circuitry protects the device from permanent damage.
- The device is not guaranteed to function outside of its operating conditions.
- Measured on JESD51-7, 4-layer PCB.

ELECTRICAL CHARACTERISTICS

V_{IN} = 3.6V, V_{EN} = V_{PWM} = high, typical values are at T_A = 25°C, unless otherwise noted.

Parameters	Symbol	Condition	Min	Typ	Max	Unit
Power Supply						
Operating input voltage	V _{IN}		2.7		5.5	V
Supply current (quiescent)	I _Q	V _{IN} = 3.6V, V _{EN} = V _{PWM} = high, no switching, I ² C active		2.4	2.7	mA
Supply current (shutdown)	I _{ST}	V _{EN} = 0V, V _{IN} = 3.6V			1	μA
Input UVLO threshold	V _{IN_UVLO}	Rising edge		2.4	2.6	V
Input UVLO hysteresis				200		mV
Oscillator						
Switching frequency	f _{SW}	Fix high f _{SW}	950	1000	1050	kHz
		Fix middle f _{SW}	475	500	525	kHz
Maximum duty cycle	D _{MAX}	f _{SW} = 500kHz	93	95		%
		f _{SW} = 1.0MHz	90	93		%
Minimum on time	T _{ON_MIN}			100		ns
Power Switch						
Switch on resistance	R _{DSON}	V _{IN} = 3.6V		250		mΩ
Current Regulation						
Minimum output current	I _{LED_min}	Linear/exponential mode		50		μA
Maximum output current	I _{LED_max}	Linear/exponential mode	24.25	25	25.75	mA
VLEDx regulation voltage	V _{REG}	I _{LED} = 25mA		220		mV
		I _{LED} = 5mA		130		mV
Current accuracy		I _{LED} = 25mA, 2.7V - 5V, linear/exponential dimming	-3		3	%
		I _{LED} = 25mA, 3.6V, linear/exponential dimming	-2		3	
		I _{LED} = 250μA, 3.6V, linear/exponential dimming	-3		3	
Current matching ⁽⁵⁾		I _{LED} = 25mA, 2.7V - 5V, linear/exponential dimming	-1		1	%
		I _{LED} = 500μA, 2.7V - 5V, linear/exponential dimming	-1		2	
		I _{LED} = 250μA, 2.7V - 5V, linear/exponential dimming	-1		2	
EN and PWM Logic						
PWM input low threshold	V _{PWM_LO}	V _{PWM} falling			0.4	V
PWM input high threshold	V _{PWM_HI}	V _{PWM} rising	1.2			V
EN low voltage	V _{EN_LOW}	V _{EN} falling			0.4	V
EN high voltage	V _{EN_HIGH}	V _{EN} rising	1.2			V
EN and PWM pull-down resistor	R _{PD}			1000		kΩ

ELECTRICAL CHARACTERISTICS (continued)
 $V_{IN} = 3.6V$, $V_{EN} = V_{PWM} = \text{high}$, typical values are at $T_A = 25^\circ C$, unless otherwise noted.

Parameters	Symbol	Condition	Min	Typ	Max	Unit
Protection						
OVP voltage	V_{OVP}	OVP = 00	16	17	18	V
		OVP = 01	22	23	24	V
		OVP = 10	29	30	31	V
		OVP = 11	37	38	39	V
OUT under-voltage protection	V_{OUT_UV}		1.2		V	
Cycle-cycle current limit	I_{LIM}	OCP = 00	0.6	0.75	0.9	A
		OCP = 01	0.8	1	1.2	A
		OCP = 10	1	1.25	1.5	A
		OCP = 11	1.2	1.5	1.8	A
LEDx over-voltage threshold	V_{OVP_LED}		4.5	5	5.5	V
LEDX under-voltage threshold	V_{LEDX_UV}			40		mV
Thermal shutdown threshold	T_{ST}			150		$^\circ C$
Thermal shutdown hysteresis				25		$^\circ C$
PWM Input						
Minimum PWM frequency	F_{PWML}				50	Hz
Maximum PWM frequency	F_{PWMH}	24MHz sample rate	50			kHz
Minimum on time	T_{MIN_ON}	24MHz sample rate			183.3	ns
		4MHz sample rate			1100	ns
		800kHz sample rate			5500	ns
Minimum off time	T_{MIN_OFF}	24MHz sample rate			183.3	ns
		4MHz sample rate			1100	ns
		800kHz sample rate			5500	ns
PWM shutdown time	T_{PWM_SD}	24MHz sample rate		0.6		ms
		4MHz sample rate		3		ms
		800kHz sample rate		25		ms
Delay time at power on	$T_{POWERON}$	EN power on to start switching		3.5	5	ms
I²C Interface						
Input logic low	V_{IL}		0		0.4	V
Input logic high	V_{IH}		1.3			V
Output logic low	V_{OL}	$I_{LOAD} = 3mA$			0.4	V
SCLH clock frequency	f_{SCL}				1200	kHz
Setup time for (repeated) start condition	$t_{SU,STA}$		160			ns
Hold time for (repeated) start condition	$t_{HD,STA}$		160			ns
Low time for SCLH clock	t_{LOW}		160			ns
High time for SCLH clock	t_{HIGH}		60			ns
Data setup time	$t_{SU,DAT}$		10			ns
Data hold time	$t_{HD,DAT}$		0 ⁽⁷⁾		70	ns

ELECTRICAL CHARACTERISTICS (continued)
V_{IN} = 3.6V, V_{EN} = V_{PWM} = high, typical values are at T_A = 25°C, unless otherwise noted.

Parameters	Symbol	Condition	Min	Typ	Max	Unit
Rise time of SCLH clock	t _{R,SCL}		10		40	ns
Rise time of SCLH clock after repeated start and acknowledge bit	t _{R,SCL1}		10		80	ns
Fall time of SCLH clock	t _{F,SCL}		10		40	ns
Rise time of SDAH data	t _{R,SDA}		10		80	ns
Fall time of SDAH data	t _{F,SDA}		10		80	ns
Setup time for stop condition	t _{SU,STO}		160			ns
Capacitive load for SDAH line and SCLH line	C _B ⁽⁶⁾				100	pF
Capacitive load for SDAH+SDA line and SCLH+SCL line	C _B				400	pF

NOTES:

- 5) Matching is defined as the difference between the maximum to minimum current divided by 2x the average currents.
- 6) Guaranteed by design.
- 7) A device must internally provide a data hold time to bridge the underfined part between V_{IL} and V_{IH} of the falling edge of the SCLH signal. An input circuit with a threshold as low as possible for the falling edge of SCLH signal minimizes the hold time.
- 8) For the bus line load C_B between 100 and 400pF the timing parameters must be increased linearly.

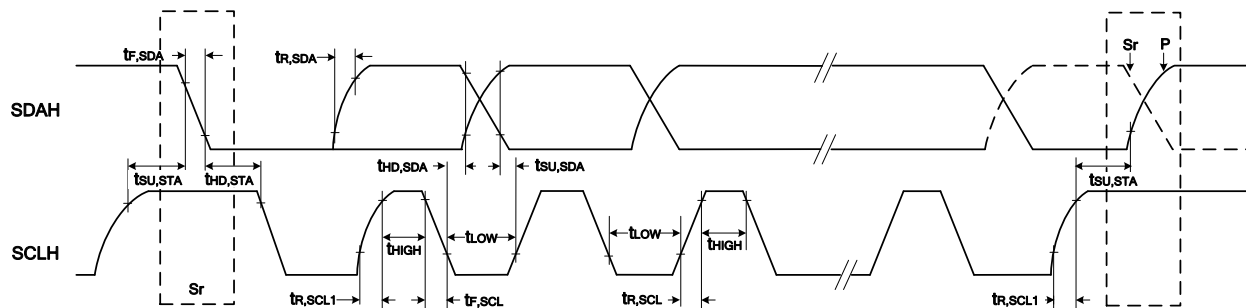

Sr: Repeated START Condition
P: STOP Condition

I²C-Compatible Interface Timing Diagram

TYPICAL PERFORMANCE CHARACTERISTICS

V_{IN} = 3.6V, 8 LEDs/string, I_{LED}/Ch = 20mA, L = 10μH, T_A = 25°C, unless otherwise noted.

LED Current for Each Channel with Register Code

Current Curve (Dimming by code only)
25mA/string

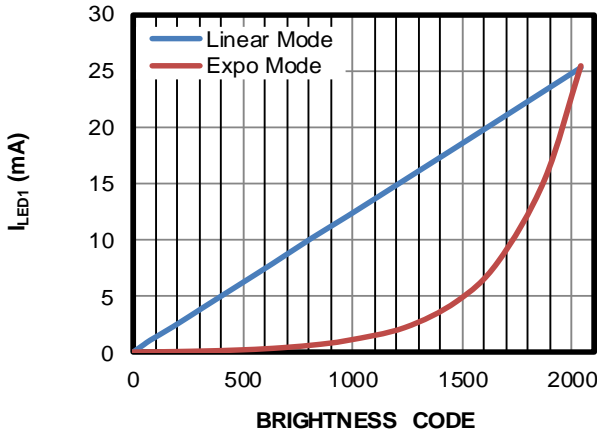

LED Current for Each Channel with PWM Only

Current Curve (Dimming by PWM only)
25mA/string

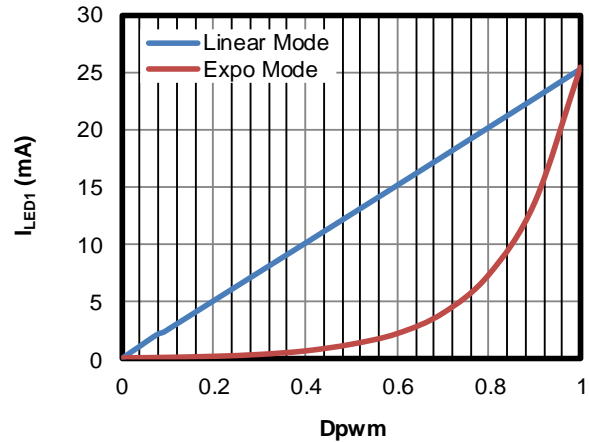

Efficiency vs. I_{LED}

V_{IN} = 3.8V, F_{sw} = 1MHz, 10μH, DCR = 280mΩ
25mA/string

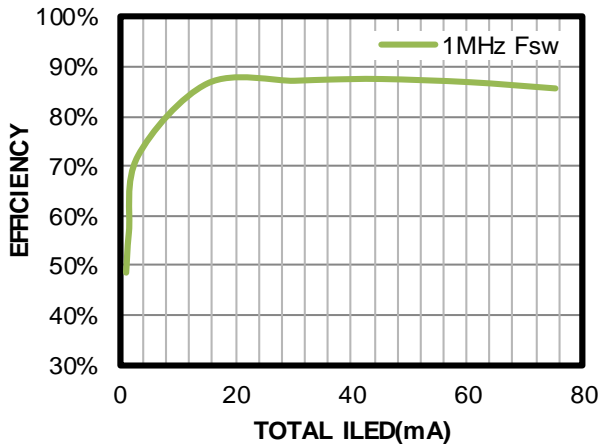

Efficiency vs. I_{LED}

V_{IN} = 3.8V, F_{sw} = 500kHz, 10μH, DCR = 280mΩ
25mA/string

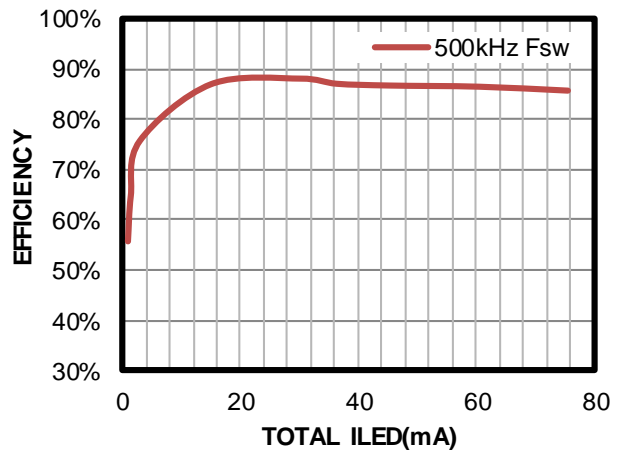

Efficiency vs. I_{LED}

V_{IN} = 3.8V, F_{sw} = 250kHz, 10μH, DCR = 280mΩ

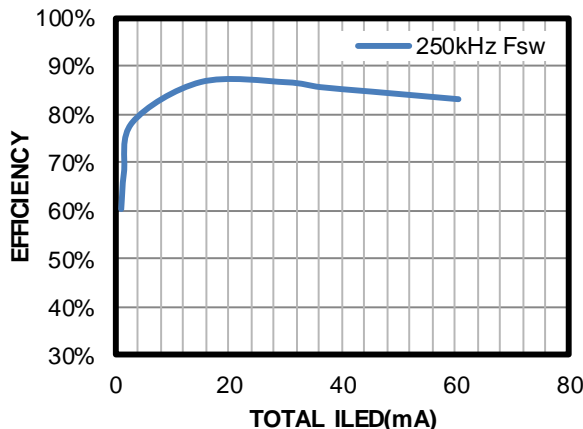

LEDx Voltage vs. LED Current

25mA/string

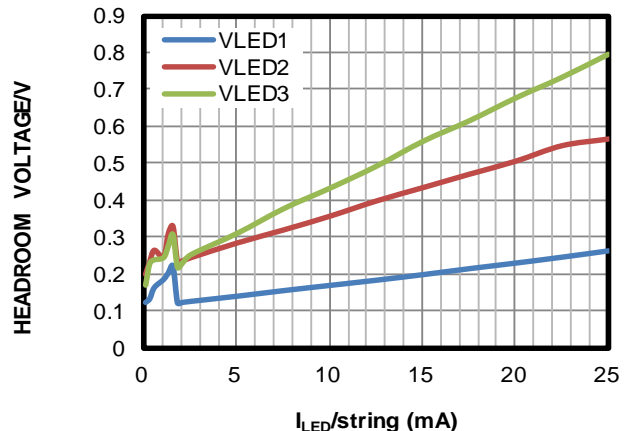

TYPICAL PERFORMANCE CHARACTERISTICS (continued)
 $V_{IN} = 3.6V$, 8 LEDs/string, $I_{LED}/Ch = 20mA$, $L = 10\mu H$, $T_A = 25^\circ C$, unless otherwise noted.

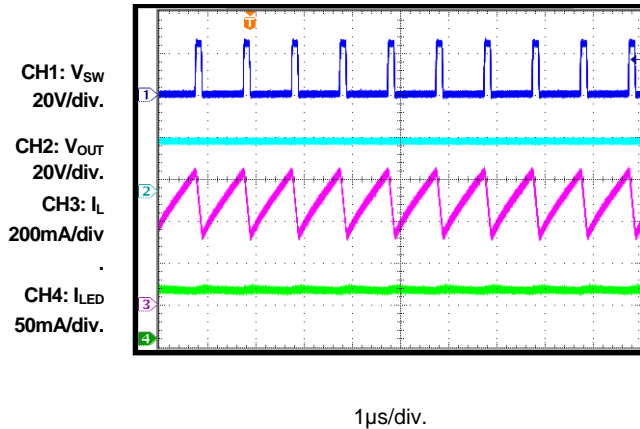
Steady State

EN Bit On

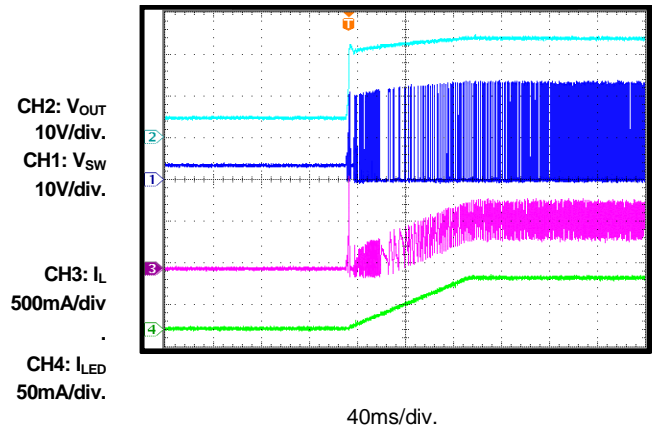
62.5µs/step

EN Bit Off

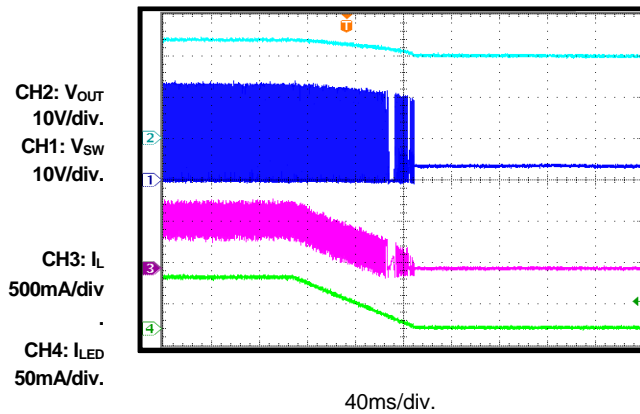
62.5µs/step

Flash Mode

Flash Time = 300ms, Flash Current = 40mA/ch

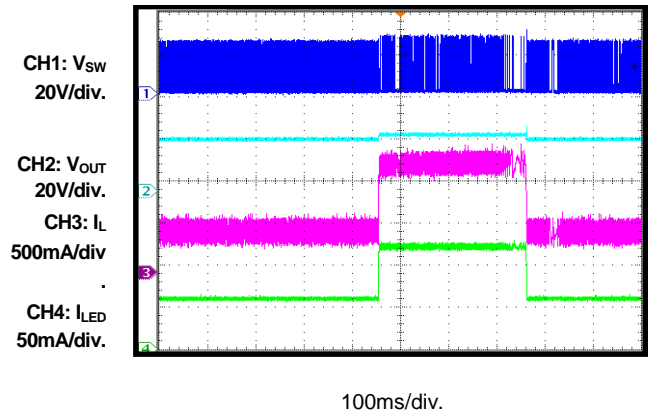
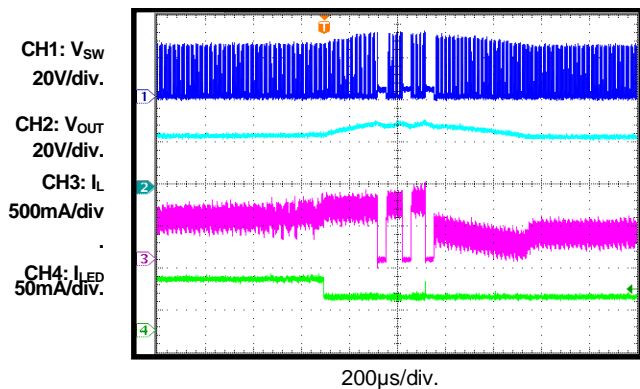

Open LED Protection (Mark Off)
 $V_{OVP} = 30V$, open one string

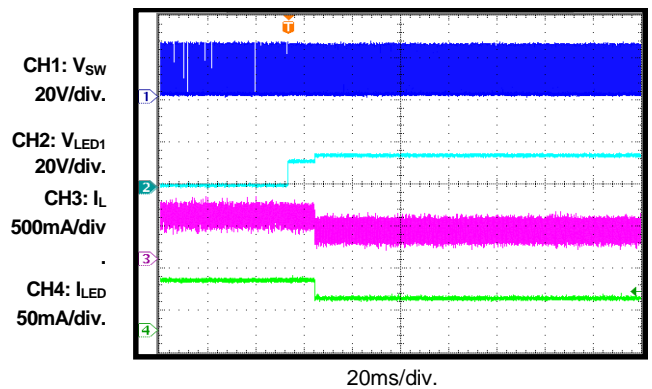
Short LED Protection (Mark Off)

Short one string

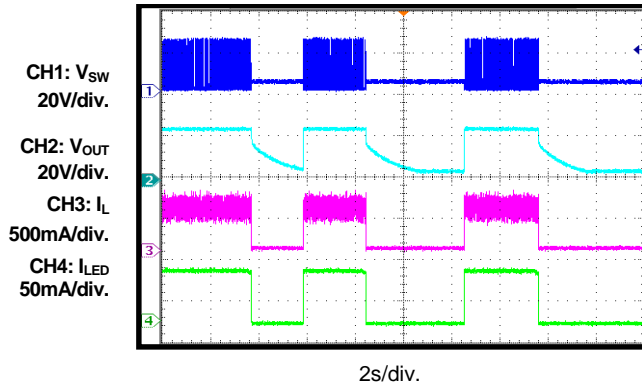

TYPICAL PERFORMANCE CHARACTERISTICS (continued)

$V_{IN} = 3.6V$, 8 LEDs/string, $I_{LED}/Ch = 20mA$, $L = 10\mu H$, $T_A = 25^\circ C$, unless otherwise noted.

**Thermal Shutdown Protection
(Recoverable)**

PIN FUNCTIONS

Pin #	Name	I/O	Description
A1	PWM	I	PWM dimming input signal. A 50Hz to 50kHz PWM pulse is recommended on PWM for analog dimming.
A2	SDA	I/O	I²C interface data signal input.
A3	EN	I	Enable. Drive EN to logic high to enable the IC. Drive EN to logic low for more than 2.5ms to shut down the IC.
B1	LED1	I	Current sink for LED1.
B2	SCL	I/O	I²C interface clock signal input.
B3	VIN	I	Power supply input. Connect a ceramic capacitor close to VIN to bypass the IC.
C1	LED2	I	Current sink for LED2.
C2, C3	GND	GND	Ground.
D1	LED3	I	Current sink for LED3.
D2	VOUT	I	Boost converter output connection. Connect VOUT to the positive node of the boost converter's output capacitor.
D3	SW	I	Drain connection for the internal N-channel power MOSFET.

OPERATION

The MP3318 is a step-up converter with peak-current-mode control architecture that employs three channels of current sink to drive three strings of white LED for an LCD panel. The MP3318 supports 11-bit resolution analog dimming via an internal register or external pulse-width modulation (PWM) input signal.

Boost Converter Switching Frequency

The boost converter switching frequency can be set through the I²C. When the register bit FS = 1, the switching frequency is set to 1MHz. When the register bit FS = 0, the switching frequency is set to 500kHz. The switching frequency can be shifted down 12% by the register FS_SHFT.

Auto-Switching Frequency

To optimize the efficiency in different load currents, the MP3318 can select the switching frequency by comparing the auto-switching frequency low threshold (register 0x16) and auto-switching frequency high threshold (register 0x15) to 8MSBs of the brightness code (register 0x19).

The auto-switching frequency function includes three different working frequency points: 1MHz, 500kHz, and 250kHz. At the high threshold, the device switches from 1MHz to 500kHz. At the low threshold, the device switches from 500kHz to 250kHz (see Table 1).

Table 1: Switching Frequency Auto-Select

8MSBs of Brightness Code (Register 0x19)	Switching Frequency
<auto-switching frequency low threshold (register 0x16)	250kHz
>auto-switching frequency low threshold (register 0x16) < auto-switching frequency high threshold (register 0x15)	500kHz
>auto-switching frequency high threshold (register 0x15)	1MHz

To disable auto-frequency, both the auto-switching frequency high threshold and low threshold must be set to zero. Once the auto-function is disabled, the MP3318 works at a fixed frequency set by the FS bit. The auto-frequency function can be enabled by setting a non-zero code for any one of the auto-switching frequency thresholds.

Note that the switching frequency -12% shift is still active when the auto-switching frequency function is enabled.

The following are test conditions for the efficiency curve in Figure 2.

- VIN = 3.8V
- 8S3P, ILED current (total) 1~75mA
- Inductor: 10μH (Wurth, 74438336100), I_R = 1.2A, I_{SAT} = 2.35A, DCR = 280mΩ

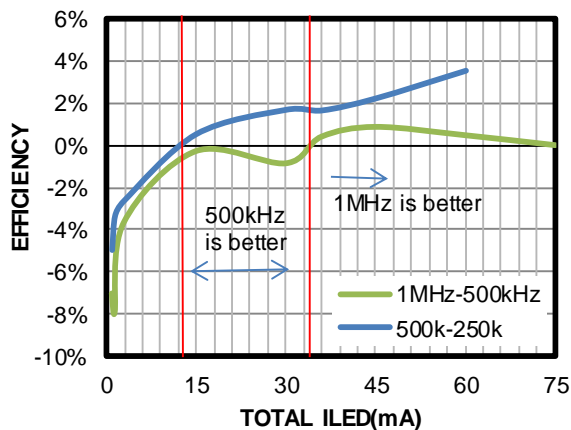

Figure 2: ΔEfficiency between Different F_{sw}

Table 2: Switching Frequency Threshold Settings

Switching Frequency	Total Threshold Current	Max Efficiency Improvement
250 - 500kHz	<12mA	5%
500k - 1MHz	<32mA	8%
1M - 500kHz	>36mA	1%

Table 2 supplies a general recommendation for auto-switching frequency current thresholds. For the first column, 250 - 500kHz means the efficiency difference between the switching frequency is 250kHz and 500kHz.

Minimum Inductor Selection

To optimize the boost converter control loop, the minimum inductance is limited for the MP3318, which is set by the minimum inductor L_MIN bit. When the L_MIN bit is set to 0, the minimum inductor is 4.7μH. When the L_MIN bit is set to 1, the minimum inductor is 10μH.

System Start-Up

If the input voltage is higher than the under-voltage lockout (UVLO) threshold and EN is pulled high, the MP3318 enters standby mode. In this mode, only the I²C is active and ready to communicate with the host. Meanwhile, the MP3318 monitors the topology connection and safety limits, including two checks:

- The MP3318 checks whether the VOUT connection is correct or not. A VOUT less than 1.2V cannot implement device switching and sets the FT_UVP bit to 1.
- The MP3318 checks if the device has triggered LED open/short protection, over-current limit protection, and over-temperature protection (OTP). If all protections pass, the MP3318 starts boosting the step-up converter with an internal soft start (note that the EN bit default value is 0).

When dimming is done by the internal code only, the PWM signal can be ignored.

Boost Converter Operation

The MP3318 uses peak-current mode to control the output voltage. At the start of each oscillator cycle, the main low-side MOSFET (LS-FET) (M1) is turned on through the control circuitry. To prevent subharmonic oscillation at duty cycles greater than 50%, a stabilizing ramp is added to the output of the current sense amplifier, and the result is fed into the positive input of the PWM generation comparator. When this voltage equals the output voltage of the error amplifier, the LS-FET is turned off. Then the inductor current flows through the free-wheeling diode, which forces the inductor current to decrease. The output voltage of the internal error amplifier is an amplified signal of the difference between the reference voltage and the feedback voltage. The converter chooses the lowest active LEDx voltage automatically to provide a bus voltage high enough to power all of the LED arrays. If the feedback voltage drops below the reference, the output of the error amplifier increases. This results in more current flowing through the MOSFET, increasing the power delivered to the output. This forms a closed loop that regulates the output voltage.

LED String Selection

There are three LED strings for the MP3318 total. Each string has an independent enable bit. This allows for 1-string, 2-string, or 3-string applications. By default, all three strings are enabled.

Flash Mode

Flash mode is employed in the MP3318 by setting the FL_EN bit to 1 during backlight mode. The flash time depends on the FL_T bit, ranging from 50 - 800ms. The flash current is set by I_FL bit.

When flash mode is enabled, the inductor peak current limit value jumps to 3A automatically, and the switching frequency jumps to the value set by the register (0x13) FS bit. The flash current returns to backlight mode when the flash is timed out. FL_EN is reset to 0, and the inductor peak current limit value resumes the setting value.

When a protection is triggered, flash mode ends, and the FL_EN bit is reset.

Dimming Control

The MP3318 supports 11-bit resolution analog dimming and features two kinds of LED current dimming curves: linear and exponential mapping.

The final LED current amplitude is set through the PWM input duty and brightness register (0x19, 0x18).

For linear analog dimming, the dimming curve and formula is shown in Equation (1):

$$I_{LED} = 40.806\mu A + 12.195\mu A \times \text{Code} \quad (1)$$

Where Code ranges from 1 - 2047. Set Code to 0 to set the LED current to 0.

For exponential analog dimming, the dimming curve and formula is shown in Equation (2):

$$I_{LED} = 51.1\mu A \times 1.003040572^{\text{Code}} \quad (2)$$

Where Code ranges from 1 - 2047. Set Code to 0 to set the LED current to 0.

Figure 2 shows the linear and exponential dimming curve for the LED current.

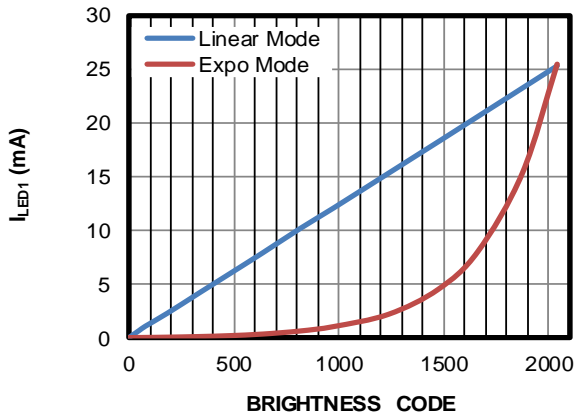

Figure 3: LED Current for Each Channel with Brightness Code

LED Current Ramp Up/Down

The LED current ramps up or down step-by-step from one brightness code to the next when the LED current slope function is enabled by setting the SLPEN bit to 1. The ramp occurs when the LED current is changed or the EN bit is on or off.

Calculate the ramp time with Equation (3):

$$t_{\text{RAMP}} = \text{RAMP} \times (\text{Code1} - \text{Code0} - 1) \quad (3)$$

Where RAMP is the slope rate set by the TSLP register, Code0 is the original brightness point, and Code1 is the target brightness point.

PWM Sample Frequency

Three different sample frequencies can be chosen for input PWM dimming signal in the MP3318.

- PWMSR1:0 = 00: sample frequency = 800kHz.
- PWMSR1:0 = 01: sample frequency = 4MHz (default).
- PWMSR1:0 = 1x: sample frequency = 24MHz.

Choose the PWM sample frequency based on the required dimming resolution, input dimming frequency, and efficiency (the higher the sample frequency, the higher the input consumption current). If a low-level PWM signal lasts for an extended period of time, the device can be disabled. The lower the PWM sample frequency is, the longer the PWM shutdown time is (see Table 3).

Table 3: PWM Shutdown Time vs. Sample Frequency

f _{sample} (Hz)	T _{PWM SD} (ms)
24M	0.6
4M	3
800k	25

PWM Hysteresis

To prevent the input PWM dimming signal jitter from causing an LED flicker, the MP3318 offers selectable PWM hysteresis values.

- HYS2:0 = 000: no hysteresis.
- HYS2:0 = 001: 1 clock.
- HYS2:0 = 100: 4 clock (default).
- HYS2:0 = 110: 6 clock.

Where 1 clock = 1/fsample. Different sample rates achieve different clocks.

The PWM hysteresis is active only when the direction of the LED brightness changes. Once the direction of the LED brightness changes, the input PWM signal must overcome the hysteresis. Otherwise, if the LED brightness changing direction remains the same, the PWM signal hysteresis function is unused.

For example, the PWM hysteresis register is set to HYS2:0 = 100 (4 clocks).

At t₀, the input PWM duty increases, when the increment of PWM duty is smaller than four clocks, there is no change to the LED current unless the input PWM duty increments are greater than four clocks. Then the LED current responds, even at tiny increments of PWM duty.

At t₁, the PWM duty decreases, and there is no change to the LED unless the decrement of the PWM duty is greater than 4 clocks. Then, if the PWM duty continues decreasing, the LED current responds immediately by ignoring the PWM hysteresis.

Brightness Control Mode

The LED current is controlled either by the input PWM dimming signal or internal brightness register.

Five different modes can be selected in the MP3318 described below.

1. Internal Register Only

When the brightness control mode bits are set to 000, the LED current is controlled by the internal brightness register only. The LED current changes only when the eight MSBs are written. Write the three LSBs first, then write the eight MSBs for the 11-bit brightness change.

In linear mapping mode, use Equation (4) and Equation (5):

$$I_{ILED0} = 40.806\mu\text{A} + 12.195\mu\text{A} \times \text{Code0} \quad (4)$$

$$I_{ILED1} = 40.806\mu\text{A} + 12.195\mu\text{A} \times \text{Code1} \quad (5)$$

In exponential mapping mode, use Equation (6) and Equation (7):

$$I_{ILED0} = 51.1\mu\text{A} \times 1.003040572^{\text{Code0}} \quad (6)$$

$$I_{ILED1} = 51.1\mu\text{A} \times 1.003040572^{\text{Code1}} \quad (7)$$

The ramp time in either mapping mode can be calculated with Equation (8):

$$t_{\text{RAMP}} = \text{RAMP} \times (\text{Code1} - \text{Code0} - 1) \quad (8)$$

2. Input PWM Duty Only

When the brightness control mode bits are set to 001, the LED current is controlled by the input dimming signal only. The internal brightness code is ignored. The MP3318 samples the PWM input duty and translates it into an 11-bit code to regulate the current. Choose a corresponding PWM frequency based on the PWM sample rate and resolution request.

In linear mapping mode, use Equation (9) and Equation (10):

$$I_{ILED0} = 40.806\mu\text{A} + 12.195\mu\text{A} \times 2047 \times D_{\text{PWM0}} \quad (9)$$

$$I_{ILED1} = 40.806\mu\text{A} + 12.195\mu\text{A} \times 2047 \times D_{\text{PWM1}} \quad (10)$$

In exponential mapping mode, use Equation (11) and Equation (12):

$$I_{ILED0} = 51.1\mu\text{A} \times 1.003040572^{2047 \times D_{\text{PWM0}}} \quad (12)$$

$$I_{ILED1} = 51.1\mu\text{A} \times 1.003040572^{2047 \times D_{\text{PWM1}}} \quad (13)$$

The ramp time in either mapping mode can be calculated with Equation (14):

$$t_{\text{RAMP}} = \text{RAMP} \times |2047 \times D_{\text{PWM1}} - 2047 \times D_{\text{PWM0}} - 1| \quad (14)$$

3. Internal Register Multiplied by the PWM Duty before Ramp

When the brightness control mode bits are set to 010, the LED current is controlled by the input PWM dimming duty multiplied by the internal brightness register. The slope step is also controlled by the PWM dimming duty multiplied by the brightness register.

In linear mode, use Equation (15) and Equation (16):

$$I_{ILED0} = 40.806\mu\text{A} + 12.195\mu\text{A} \times \text{Code0} \times D_{\text{PWM0}} \quad (15)$$

$$I_{ILED1} = 40.806\mu\text{A} + 12.195\mu\text{A} \times \text{Code1} \times D_{\text{PWM1}} \quad (16)$$

In exponential mode, use Equation (17) and Equation (18):

$$I_{ILED0} = 51.1\mu\text{A} \times 1.003040572^{\text{Code0} \times D_{\text{PWM0}}} \quad (17)$$

$$I_{ILED1} = 51.1\mu\text{A} \times 1.003040572^{\text{Code1} \times D_{\text{PWM1}}} \quad (18)$$

The ramp time in either mapping mode can be calculated with Equation (19):

$$t_{\text{RAMP}} = \text{RAMP} \times |\text{Code1} \times D_{\text{PWM1}} - \text{Code0} \times D_{\text{PWM0}} - 1| \quad (19)$$

4. Ramp before Internal Register Multiplied by the Input PWM Dimming Duty, LED Slope Step Controlled by Internal Register Only

When the brightness control mode bits are set to 011, the LED current is controlled by the input PWM dimming duty multiplied by the internal brightness register, and the slope step is controlled by the internal brightness register only.

In this mode, the LED current jumps immediately when the external PWM dimming duty changes. Then the LED current changes step-by-step to the new brightness register.

In linear mapping mode, the original current can be calculated with Equation (20):

$$I_{ILED0-} = 40.806\mu\text{A} + 12.195\mu\text{A} \times \text{Code0} \times D_{\text{PWM0}} \quad (20)$$

The LED current jumps immediately when the duty changes, as shown in Equation (21):

$$I_{ILED0+} = 40.806\mu\text{A} + 12.195\mu\text{A} \times \text{Code0} \times D_{\text{PWM1}} \quad (21)$$

Then, the LED current follows the code change, shown in Equation (22):

$$I_{ILED1} = 40.806\mu\text{A} + 12.195\mu\text{A} \times \text{Code1} \times D_{P_{PWM1}} \quad (22)$$

In exponential mapping mode, the original current can be calculated with Equation (23):

$$I_{ILED0-} = 51.1\mu\text{A} \times 1.003040572^{\text{Code0} \times D_{P_{PWM0}}} \quad (23)$$

The LED current jumps immediately when the duty changes, shown in Equation (24):

$$I_{ILED0+} = 51.1\mu\text{A} \times 1.003040572^{\text{Code0} \times D_{P_{PWM1}}} \quad (24)$$

Then, the LED current follows the code change, shown in Equation (25):

$$I_{ILED1} = 51.1\mu\text{A} \times 1.003040572^{\text{Code1} \times D_{P_{PWM1}}} \quad (25)$$

The ramp time in either mode can be calculated with Equation (26):

$$t_{RAMP} = RAMP \times |\text{Code1} - \text{Code0} - 1| \quad (26)$$

The original LED current can be calculated with Equation (27):

$$I_{ILED0-} = 40.806\mu\text{A} + 12.195\mu\text{A} \times (1024 \times 0.5) = 6.28\text{mA} \quad (27)$$

Then the LED current jumps immediately, as shown in Equation (28):

$$I_{ILED0+} = 40.806\mu\text{A} + 12.195\mu\text{A} \times (1024 \times 1) = 12.52\text{mA} \quad (28)$$

The LED current rises up step-by-step, shown in Equation (29):

$$I_{ILED1} = 40.806\mu\text{A} + 12.195\mu\text{A} \times (2047 \times 1) = 25\text{mA} \quad (29)$$

The ramp up time can be calculated with Equation (30):

$$t_{RAMP} = 1\text{ms}/\text{step} \times |2047 - 1024 - 1| = 1022\text{ms} \quad (30)$$

5. LED Current Multiplied by the Input PWM Duty, LED Slope Step Controlled by Internal Register Only

When the brightness control mode bits are set to 100, the LED current is dimmed by the input PWM dimming duty. The slope step is controlled by the internal brightness register only.

In linear mode, use Equation (31) and Equation (32):

$$I_{ILED0} = (40.806\mu\text{A} + 12.195\mu\text{A} \times \text{Code0}) \times D_{P_{PWM0}} \quad (31)$$

$$I_{ILED1} = (40.806\mu\text{A} + 12.195\mu\text{A} \times \text{Code1}) \times D_{P_{PWM1}} \quad (32)$$

In exponential mode, use Equation (33) and Equation (34):

$$I_{ILED0} = 51.1\mu\text{A} \times 1.003040572^{\text{Code0}} \times D_{P_{PWM0}} \quad (33)$$

$$I_{ILED1} = 51.1\mu\text{A} \times 1.003040572^{\text{Code1}} \times D_{P_{PWM1}} \quad (34)$$

The ramp time in either mode can be calculated with Equation (35):

$$t_{RAMP} = RAMP \times |\text{Code1} - \text{Code0} - 1| \quad (35)$$

Cycle-by-Cycle Current Limit

To prevent the external components from exceeding a current stress rating, the MP3318 uses a cycle-by-cycle current limit protection. The limit value can be selected by the register bit CL1:0. When the internal LS-FET current exceeds the current limit threshold, the MOSFET turns off until the next clock cycle begins.

The current-limit threshold is dependent on the inductor peak current, which is decided on by the boost convert working conditions, including the inductor value (L), input voltage (V_{IN}), output voltage (V_{OUT}), total LED string current (I_{OUT}), switching frequency (f_{SW}), and boost converter efficiency (η).

For the boost converter, if Equation (36) is satisfied, then the inductor current works in continuous conduction mode (CCM). Otherwise, it works in discontinuous conduction mode (DCM).

$$\frac{I_{OUT} \times V_{OUT}}{V_{IN} \times \eta} > \frac{V_{IN}}{f_{SW} \times L} \times \left(1 - \frac{V_{IN} \times \eta}{V_{OUT}}\right) \quad (36)$$

For CCM, the peak current can be calculated with Equation (37):

$$I_{PEAK} = \frac{I_{OUT} \times V_{OUT}}{V_{IN} \times \eta} + \left[\frac{V_{IN}}{2 \times f_{SW} \times L} \times \left(1 - \frac{V_{IN} \times \eta}{V_{OUT}}\right) \right] \quad (37)$$

For DCM, the peak current can be calculated with Equation (38):

$$I_{PEAK} = \sqrt{\frac{2 \times I_{OUT}}{f_{SW} \times L \times \eta}} \times (V_{OUT} - V_{IN} \times \eta) \quad (38)$$

Additionally, while the MP3318 works in flash mode, the current limit jumps to 3A automatically.

Over-Current Protection (OCP)

The FT_OCP flag is set when over-current protection (OCP) occurs. To avoid the transient over-current from setting the FT_OCP bit, the MP3318 has an OCP counter. If the inductor current always reaches the threshold in a 128μs period, the counter increases by 1. If the OCP counter is higher than 2 every eight 128μs periods, the FT_OCP bit is set to 1.

Over-Voltage Protection (OVP) and Open-String Protection

When VOUT is higher than the OVP threshold, over-voltage protection (OVP) is triggered, the IC stops switching, and the FT_OVP bit is set. When the output voltage drops low, switching resumes.

The OVP threshold is set by the internal register OVP1:0. Four different thresholds can be selected.

- OVP1:0 = 00: 17V
- OVP1:0 = 01: 23V
- OVP1:0 = 10: 30V
- OVP1:0 = 11 (default): 38V

If the LED string is open, the feedback voltage is lower than the reference voltage. Therefore, VOUT rises up and continues charging the output capacitor until VOUT reaches the protection point (V_{OVP}), triggering OVP.

The IC also monitors the LEDx voltage. When the LEDx voltage is lower than 40mV, open LED protection is triggered. After the fault, two different actions, set by OVP_MD1:0 through the I²C, can be triggered.

If OVP_MD1:0 = 00, FT_OVP is set, and FT_OLP is set. If OVP_MD1:0 = 01, FT_OVP is set, FT_OLP is set, and the string with LEDx < 40mV is marked off.

Short LED Protection

The MP3318 monitors the LEDx pin voltage to determine if a short string has occurred. If a short string occurs, the respective LEDx pin is pulled up and can tolerate high voltage stress. If the LEDx pin voltage is higher than the short-protection threshold and last for 2ms, a short string fault is detected. The threshold is set by S_TH1:0.

The short LED protection is programmed by the SLP_MD1:0 as follows.

- SLP_MD1:0 = 00: the short LED fault detection is disabled.
- SLP_MD1:0 = 01: the short LED fault detection is enabled, and FT_SLP is set when the fault is detected.
- SLP_MD1:0 = 10: the short LED fault detection is enabled, FT_SLP is set and marks off the string with the LEDx voltage higher than the threshold.

Thermal Shutdown Protection

To prevent the IC from operating at exceedingly high temperatures, thermal shutdown is implemented by detecting the silicon die temperature. When the die temperature exceeds the upper threshold (T_{ST}), the IC shuts down and resumes normal operation when the die temperature drops below the lower threshold. Typically, the hysteresis value is 25°C

I²C INTERFACE REGISTER DESCRIPTION

I²C Chip Address

The 7-bit MSB device address is 0x36. After the start condition, the I²C-compatible master sends a 7-bit address followed by an eighth read (1) or write (0) bit.

The following bit indicates the register address to or from which the data is written or read.

0	1	1	0	1	1	0	r/w
---	---	---	---	---	---	---	-----

Figure 4: I²C Compatible Device Address

To avoid a glitch in the operation, the following registers change only when the IC EN bit (0x10, bit[0]) or the three LED channel enable bits (0x10, bit[3:1]) are set to 0.

1. Mapping mode bit (MAPMOD, 0x11, bit[7])
2. Brightness mode bits (BRTMD2:0, 0x11, bit[6:4])
3. Slope enable bit (SLPEN, 0x11, bit[3])
4. Slope time bits (TSLP2:0, 0x11, bit[2:0])
5. PWM sample rate bits (PWMSR1:0, 0x12, bit[7:6])
6. PWM polarity bit (PWM_P, 0x12, bit[5])
7. PWM hysteresis bits (HYS2:0, 0x12, bit [4:2])
8. PWM filter bits (FILTER1:0, 0x12, bit[1:0])
9. Auto-frequency high threshold bits (FS_AUTOH7:0, 0x15, bit[7:0])
10. Auto-frequency low threshold bits (FS_AUTOL7:0, 0x16, bit[7:0])

Register Mapping

Addr	D7	D6	D5	D4	D3	D2	D1	D0	
00H	DEV_ID3	DEV_ID2	DEV_ID1	DEV_ID0	REV_ID3	REV_ID2	REV_ID1	REV_ID0	
01H	RESERVED							SRST	
10H	RESERVED				CH1EN	CH2EN	CH3EN	EN	
11H	MAPMD	BRTMD2:0			SLPEN	TSLP2:0			
12H	PWMSR1:0		PWM_P	HYS2:0			FILTER1:0		
13H	NA	FS_SHFT	FS	L_MIN	OVP1:0		CL1:0		
15H	FS_AUTOH7:0								
16H	FS_AUTOL7:0								
17H	FL_T3:0				IFL2:0			FL_EN	
18H	RESERVED					BRT2:0			
19H	BRT10:3								
1EH	S_TH1:0		SLP_MD1:0		OVP_MD1:0		OTP_SD	OCP_SD	
1FH	RESERVED		FT_UVP	FT_OLP	FT_SLP	FT_OTP	FT_OCP	FT_OVP	

Chip ID Register

Addr: 0x00				
Bit	Bit Name	Access	Default	Description
7:4	DEV_ID	r	0010	Device ID.
3:0	REV_ID	r	0010	Revision ID.

Software Reset Register

Addr: 0x01				
Bit	Bit Name	Access	Default	Description
7:1	N/A	r	N/A	Reserved.
0	SRST	r/w	0	Software reset bit. 0: normal operation 1: device reset, all registers are reset to default (this bit resets back to 0 automatically)

Enable Register

Addr: 0x10				
Bit	Bit Name	Access	Default	Description
7:4	N/A	r	N/A	Reserved.
3	CH1EN	r/w	1	LED1 enable bit. 1: LED1 enabled 0: LED1 disabled
2	CH2EN	r/w	1	LED2 enable bit. 1: LED2 enabled 0: LED2 disabled
1	CH3EN	r/w	1	LED3 enable bit. 1: LED3 enabled 0: LED3 disabled
0	EN	r/w	0	IC enable bit 1: IC enabled 0: IC disabled

Brightness Control Register

Addr: 0x11				
Bit	Bit Name	Access	Default	Description
7	MAPMD	r/w	0	LED current mapping mode bit. 0: linear mapping 1: exponential mapping
6:4	BRTMD2:0	r/w	011	Brightness mode control bits. 000: brightness register only 001: PWM duty only 010: brightness register multiplied by PWM duty before ramp 011: ramp before brightness register multiplied by PWM duty 100: LED current multiplied by PWM duty
3	SLPEN	r/w	0	LED current slope enable bit. 0: LED current slope disabled 1: LED current slope enabled
2:0	TSLP2:0	r/w	000	LED current slope time for each step. 000: 7.8125µs/step 001: 15.625µs/step 010: 31.25µs/step 011: 62.5µs/step 100: 125µs/step 101: 250µs/step 110: 500µs/step 111: 1000µs/step

PWM Control Register

Addr: 0x12				
Bit	Bit Name	Access	Default	Description
7:6	PWMSR	r/w	01	PWM sample frequency set bits. 00: 800kHz 01: 4MHz 1x: 24MHz
5	PWM_P	r/w	1	PWM input polarity set bit. 0: active low 1: active high
4:2	HYS2:0	r/w	100	PWM hysteresis set bits. 000: no hysteresis 001: 1 clock 010: 2 clocks 011: 3 clocks 100: 4 clocks 101: 5 clocks 110: 6 clocks 111: reserved
1:0	FILTER1:0	r/w	11	PWM input filter bits. 00: no filter 01: 80ns 10: 160ns 11: 240ns

Boost Control Register

Addr: 0x13				
Bit	Bit Name	Access	Default	Description
7	N/A	r	N/A	Reserved.
6	FS_SHFT	r/w	1	Switching frequency shift bit. 0: -12% shift 1: no shift
5	FS	r/w	1	Boost switching frequency set bit. 0: 500kHz 1: 1MHz
4	L_MIN	r/w	0	Minimum inductor select bit. 0: 4.7μH 1: 10μH
3:2	OVP1:0	r/w	11	Over-voltage protection set bits. 00: 17V 01: 23V 10: 30V 11: 38V
1:0	CL1:0	r/w	11	Current-limit set bits. 00: 0.75A 01: 1A 10: 1.25A 11: 1.5A

Auto-Switching Frequency High Threshold

Addr: 0x15				
Bit	Bit Name	Access	Default	Description
7:0	FS_AUTOH	r/w	00000000	Auto-switching frequency high threshold (500kHz to 1MHz). Compare with the eight MSBs of the brightness code. Function is disabled when both FS_AUTOH and FS_AUTOL are set to 0.

Auto-Switching Frequency Low Threshold

Addr: 0x16				
Bit	Bit Name	Access	Default	Description
7:0	FS_AUTOL	r/w	00000000	Auto-switching frequency low threshold (250kHz to 500kHz). Compare with the eight MSBs of the brightness code. Function is disabled when both FS_AUTOH and FS_AUTOL are set to 0.

Flash Mode Control Register

Addr: 0x17				
Bit	Bit Name	Access	Default	Description
7:4	FL_T	r/w	0101 (300ms)	Flash time set register. 50ms/step. 0000: 50ms 0001: 100ms 1111: 800ms
3:1	IFL2:0	r/w	100 (40mA)	Flash current set register. 5mA/step. 000: 20mA 001: 25mA 110: 50mA 111: reserved
0	FL_EN	r/w	0	Backlight flash mode enable bit. Resets to 0 automatically when flash timeout or protection is triggered. 0: disable 1: enable

Brightness Register LSB

Addr: 0x18				
Bit	Bit Name	Access	Default	Description
7:3	N/A	r	N/A	Reserved.
2:0	BRT2:0	r/w	111	3-bit LSB of brightness register.

Brightness Register MSB

Addr: 0x19				
Bit	Bit Name	Access	Default	Description
7:0	BRT10:3	r/w	11111111	8-bit MSB of brightness register.

Fault Control Register

Addr: 0x1E				
Bit	Bit Name	Access	Default	Description
7:6	S_TH	r/w	01	LED short-protection threshold setting. If the LEDx voltage is higher than the threshold, short protection is triggered. 00: 2V 01: 3V 10: 5V 11: reserved
5:4	SLP_MD	r/w	00	LED short-protection mode selection. 00: LED short protection is disabled 01: FT_SLP is set when fault is detected 10: FT_SLP is set and the fault string is marked off 11: reserved
3:2	OVP_MD	r/w	00	Over-voltage protection mode selection. 00: FT_OVP is set when fault is detected 01: FT_OVP is set and open string is mark off 1x: reserved
1:0	N/A	r	N/A	Reserved.

Fault Flag Register

Addr: 0x1F				
Bit	Bit Name	Access	Default	Description
7:6	N/A	r	N/A	Reserved.
5	FT_UVP	r	0	Output under-voltage fault flag. 0: no fault 1: fault, clear after read-back
4	FT_OLP	r	0	LED open fault flag. 0: no fault 1: fault, clear after read-back
3	FT_SLP	r	0	LED short fault flag. 0: no fault 1: fault, clear after read-back
2	FT_OTP	r	0	Thermal shutdown fault flag. 0: no fault 1: fault, clear after read-back
1	FT_OCP	r	0	OCP fault flag. 0: no fault 1: fault, clear after read-back
0	FT_OVP	r	0	Output voltage OVP fault flag. 0: no fault 1: fault, clear after read-back

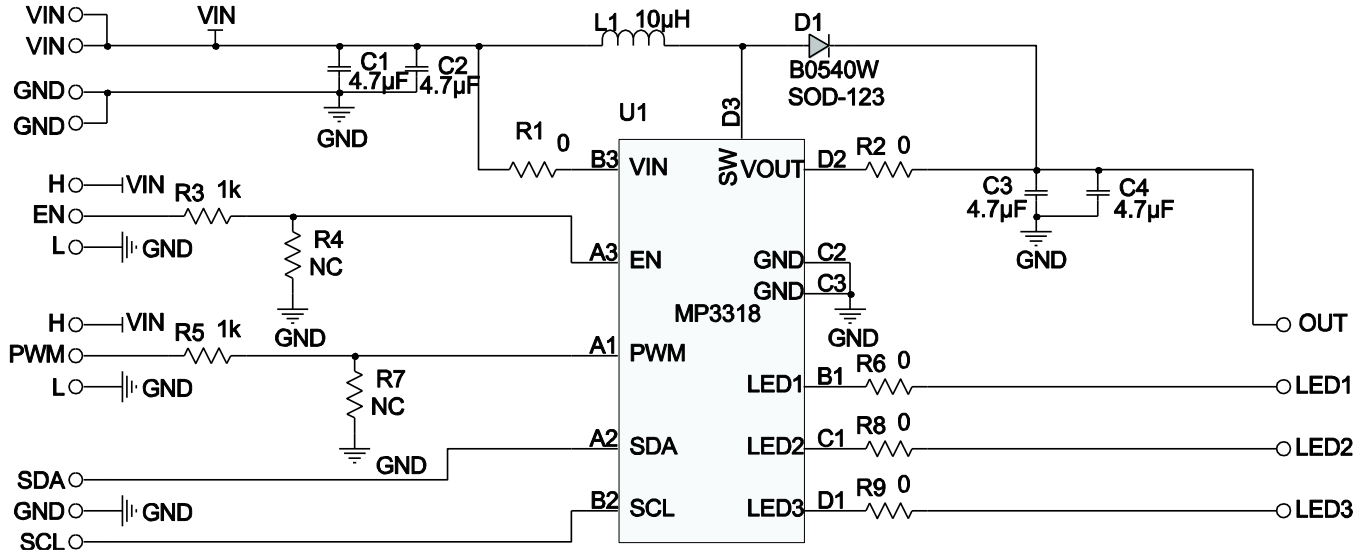
TYPICAL APPLICATION CIRCUIT

Figure 5: Typical Application for Single String 3*7LEDs, 20mA/String

PACKAGE INFORMATION

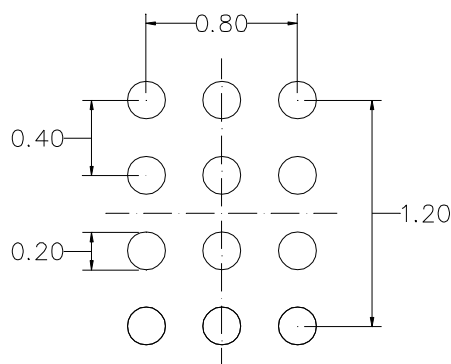
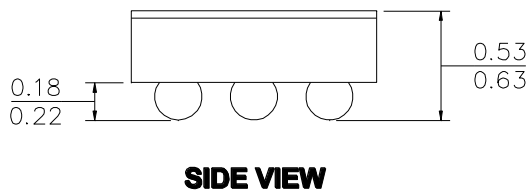
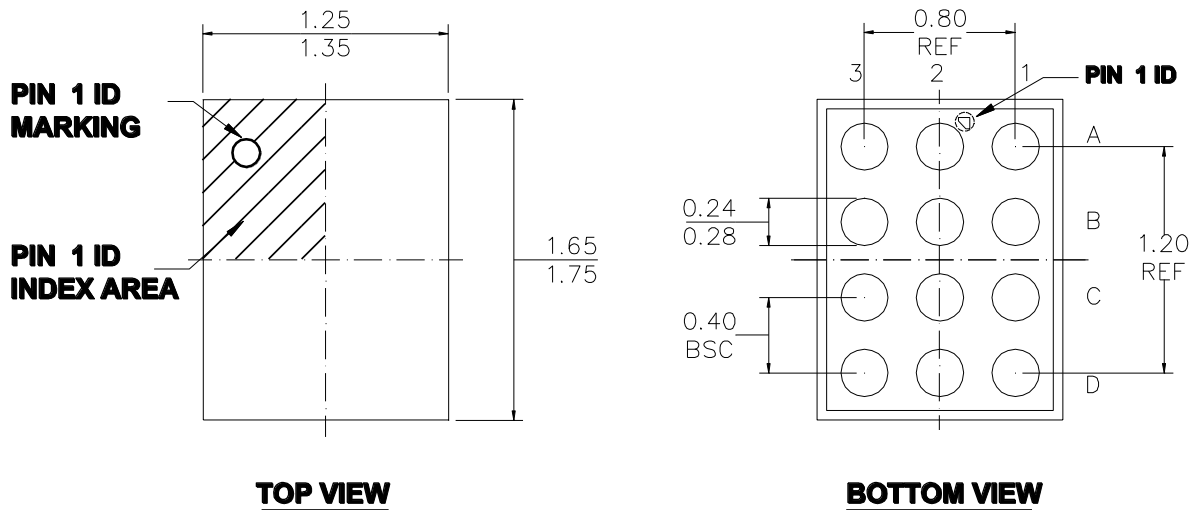
WLCSP-12 (1.3mmx1.7mm)



NOTE:

- 1) ALL DIMENSIONS ARE IN MILLIMETERS.
- 2) BALL COPLANARITY SHALL BE 0.05 MILLIMETER MAX.
- 3) JEDEC REFERENCE IS MO-211.
- 4) DRAWING IS NOT TO SCALE.

NOTICE: The information in this document is subject to change without notice. Please contact MPS for current specifications. Users should warrant and guarantee that third party Intellectual Property rights are not infringed upon when integrating MPS products into any application. MPS will not assume any legal responsibility for any said applications.

Компания «Life Electronics» занимается поставками электронных компонентов импортного и отечественного производства от производителей и со складов крупных дистрибьюторов Европы, Америки и Азии.

С конца 2013 года компания активно расширяет линейку поставок компонентов по направлению коаксиальный кабель, кварцевые генераторы и конденсаторы (керамические, пленочные, электролитические), за счёт заключения дистрибьюторских договоров

Мы предлагаем:

- Конкурентоспособные цены и скидки постоянным клиентам.
- Специальные условия для постоянных клиентов.
- Подбор аналогов.
- Поставку компонентов в любых объемах, удовлетворяющих вашим потребностям.
- Приемлемые сроки поставки, возможна ускоренная поставка.
- Доставку товара в любую точку России и стран СНГ.
- Комплексную поставку.
- Работу по проектам и поставку образцов.
- Формирование склада под заказчика.
- Сертификаты соответствия на поставляемую продукцию (по желанию клиента).
- Тестирование поставляемой продукции.
- Поставку компонентов, требующих военную и космическую приемку.
- Входной контроль качества.
- Наличие сертификата ISO.

В составе нашей компании организован Конструкторский отдел, призванный помогать разработчикам, и инженерам.

Конструкторский отдел помогает осуществить:

- Регистрацию проекта у производителя компонентов.
- Техническую поддержку проекта.
- Защиту от снятия компонента с производства.
- Оценку стоимости проекта по компонентам.
- Изготовление тестовой платы монтаж и пусконаладочные работы.



Тел: +7 (812) 336 43 04 (многоканальный)

Email: org@lifeelectronics.ru