

GaAs MMIC 6-BIT DIGITAL PHASE SHIFTER, 9 - 12.5 GHz

Typical Applications

The HMC642 is ideal for:

- EW Receivers
- Weather & Military Radar
- Satellite Communications
- Beamforming Modules
- Phase Cancellation

Functional Diagram

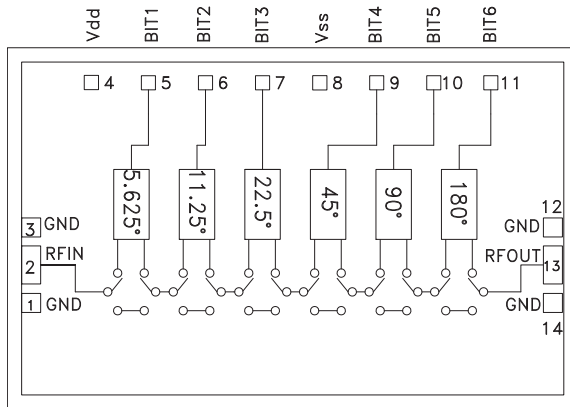

Features

- Low RMS Phase Error: 2.5°
- Low Insertion Loss: 6.5 dB
- High Linearity: +41 dBm
- Positive Control Voltage
- 360° Coverage, LSB = 5.625°
- Die Size: 3.25 x 1.9 x 0.1 mm

General Description

The HMC642 is a 6-bit digital phase shifter die which is rated from 9 to 12.5 GHz, providing 360 degrees of phase coverage, with a LSB of 5.625 degrees. The HMC642 features very low RMS phase error of 2.5 degrees and extremely low insertion loss variation of ± 0.25 dB across all phase states. This high accuracy phase shifter is controlled with positive control logic of 0/+5V, and is internally matched to 50 Ohms with no external components.

Electrical Specifications, $T_A = +25^\circ\text{C}$, Vee = -5V, Vdd = +5V, Control Voltage = 0/+5V, 50 Ohm System

Parameter	Min.	Typ.	Max.	Units
Frequency Range	9		12.5	GHz
Insertion Loss*		6.5	8.5	dB
Input Return Loss*		13		dB
Output Return Loss*		12		dB
Phase Error*		± 5	+15 / -8	deg
RMS Phase Error		2.5		deg
Insertion Loss Variation*		± 0.25		dB
Input Power for 1 dB Compression		28		dBm
Input Third Order Intercept		41		dBm
Control Voltage Current		<250		μA
Bias Control Current		<12		mA

*Note: Major States Shown

**GaAs MMIC 6-BIT DIGITAL
PHASE SHIFTER, 9 - 12.5 GHz**

Insertion Loss, Major States Only



Normalized Loss, Major States Only



Input Return Loss, Major States Only



Phase Error, Major States Only



Output Return Loss, Major States Only

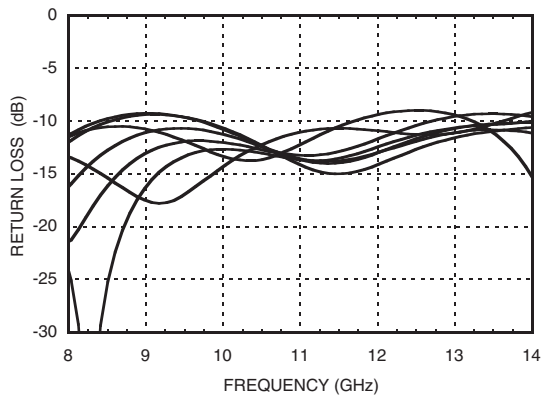

**Relative Phase Shift
Major States, Including All Bits**

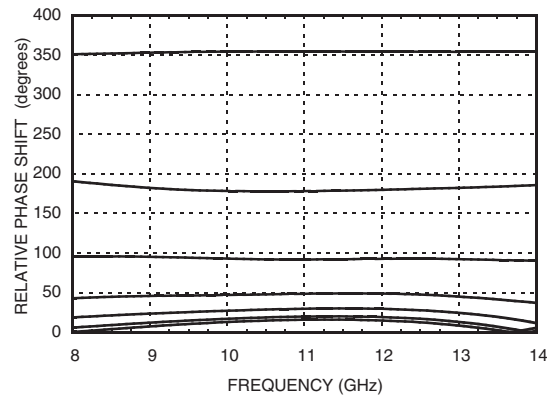

Information furnished by Analog Devices is believed to be accurate and reliable. However, no responsibility is assumed by Analog Devices for its use, nor for any infringements of patents or other rights of third parties that may result from its use. Specifications subject to change without notice. No license is granted by implication or otherwise under any patent or patent rights of Analog Devices. Trademarks and registered trademarks are the property of their respective owners.

For price, delivery, and to place orders: Analog Devices, Inc., One Technology Way, P.O. Box 9106, Norwood, MA 02062-9106 Phone: 781-329-4700 • Order online at www.analog.com Application Support: Phone: 1-800-ANALOG-D

**GaAs MMIC 6-BIT DIGITAL
PHASE SHIFTER, 9 - 12.5 GHz**

**Relative Phase Shift,
RMS, Average, Max, All States**

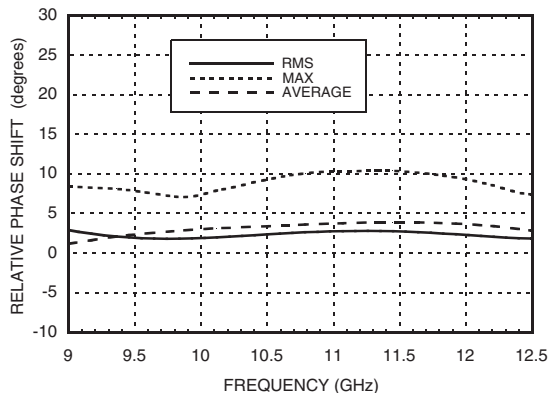

Input IP3, Major States Only

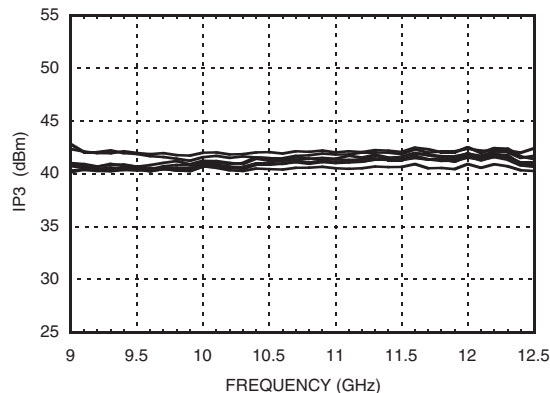

Input IP2, Major States Only

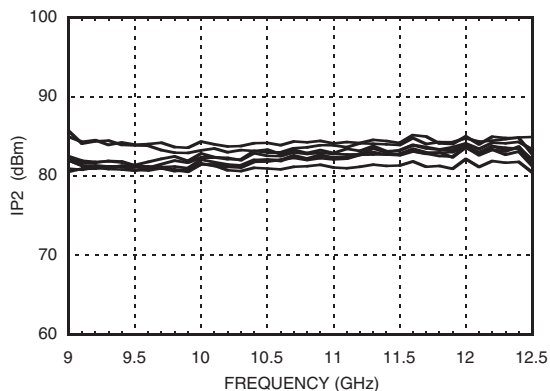

Input P1dB, Major States Only

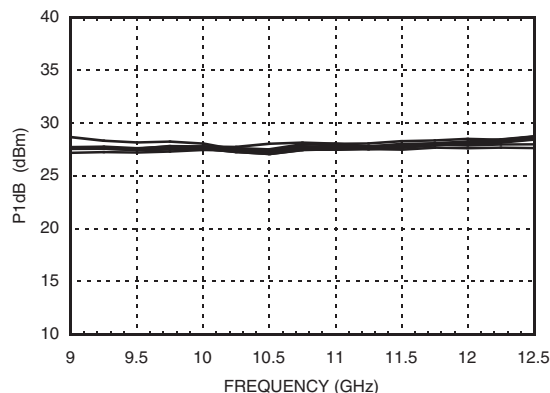

RMS Phase Error vs. Temperature

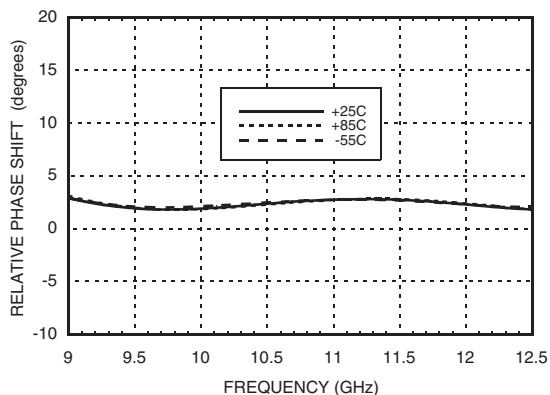

**Insertion Loss vs. Temperature,
Major States Only**

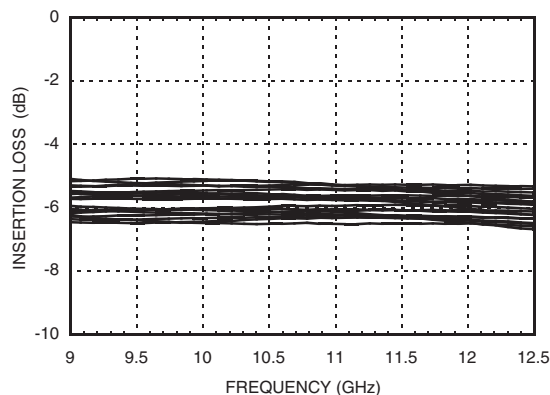

Information furnished by Analog Devices is believed to be accurate and reliable. However, no responsibility is assumed by Analog Devices for its use, nor for any infringements of patents or other rights of third parties that may result from its use. Specifications subject to change without notice. No license is granted by implication or otherwise under any patent or patent rights of Analog Devices. Trademarks and registered trademarks are the property of their respective owners.

For price, delivery, and to place orders: Analog Devices, Inc., One Technology Way, P.O. Box 9106, Norwood, MA 02062-9106 Phone: 781-329-4700 • Order online at www.analog.com Application Support: Phone: 1-800-ANALOG-D

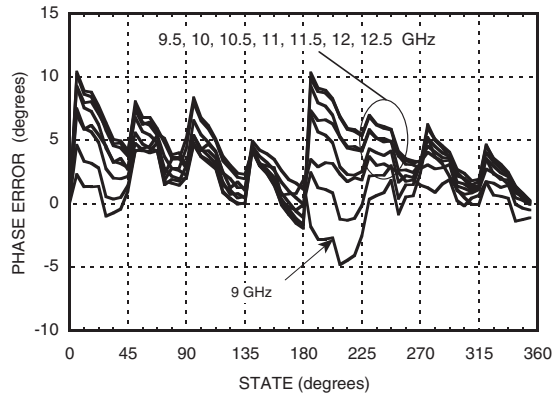
**GaAs MMIC 6-BIT DIGITAL
PHASE SHIFTER, 9 - 12.5 GHz**
Phase Error vs. State

Absolute Maximum Ratings

Input Power (RFIN)	30 dBm (T= +85 °C)
Bias Voltage Range (Vdd)	-0.2 to +12V
Bias Voltage Range (Vss)	+0.2 to -12V
Channel Temperature (Tc)	150 °C
Thermal Resistance (channel to die bottom)	60 °C/W
Storage Temperature	-65 to +150 °C
Operating Temperature	-55 to +85 °C

**ELECTROSTATIC SENSITIVE DEVICE
OBSERVE HANDLING PRECAUTIONS**
Truth Table

Control Voltage Input						Phase Shift (Degrees) RFIN - RFOUT
Bit 1	Bit 2	Bit 3	Bit 4	Bit 5	Bit 6	
0	0	0	0	0	0	Reference*
1	0	0	0	0	0	5.625
0	1	0	0	0	0	11.25
0	0	1	0	0	0	22.5
0	0	0	1	0	0	45.0
0	0	0	0	1	0	90.0
0	0	0	0	0	1	180.0
1	1	1	1	1	1	354.375

Any combination of the above states will provide a phase shift approximately equal to the sum of the bits selected.

*Reference corresponds to monotonic setting



Bias Voltage & Current

Vdd	Idd
5.0	5.6mA
Vss	Iss
-5.0	5.6mA

Control Voltage

State	Bias Condition
Low (0)	0 to 0.2 Vdc
High (1)	Vdd ±0.2 Vdc @ 35 µA Typ.

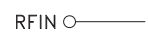
Pad Descriptions

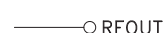
Pad Number	Function	Description	Interface Schematic
1, 3, 12, 14	GND	These pads and die bottom must be connected to RF/DC ground.	
2	RFIN	This port is DC coupled and matched to 50 Ohms.	
4	Vdd	Voltage supply.	
5 - 7, 9 - 11	BIT1, BIT2, BIT3, BIT4, BIT5, BIT6	Control Input. See truth table and control voltage tables.	
8	Vss	Voltage supply.	
13	RFOUT	This port is DC coupled and matched to 50 Ohms.	

**GaAs MMIC 6-BIT DIGITAL
PHASE SHIFTER, 9 - 12.5 GHz**

Outline Drawing



Die Packaging Information [1]

Standard	Alternate
GP-1 (Gel Pack)	[2]

[1] Refer to the "Packaging Information" section for die packaging dimensions.

[2] For alternate packaging information contact Hittite Microwave Corporation.

NOTES:

1. ALL DIMENSIONS IN INCHES (MILLIMETERS)
2. DIE THICKNESS IS 0.004
3. BACKSIDE METALLIZATION: GOLD
4. BACKSIDE METAL IS GROUND
5. BOND PADS METALLIZATION: GOLD
6. OVERALL DIE SIZE ± 0.002

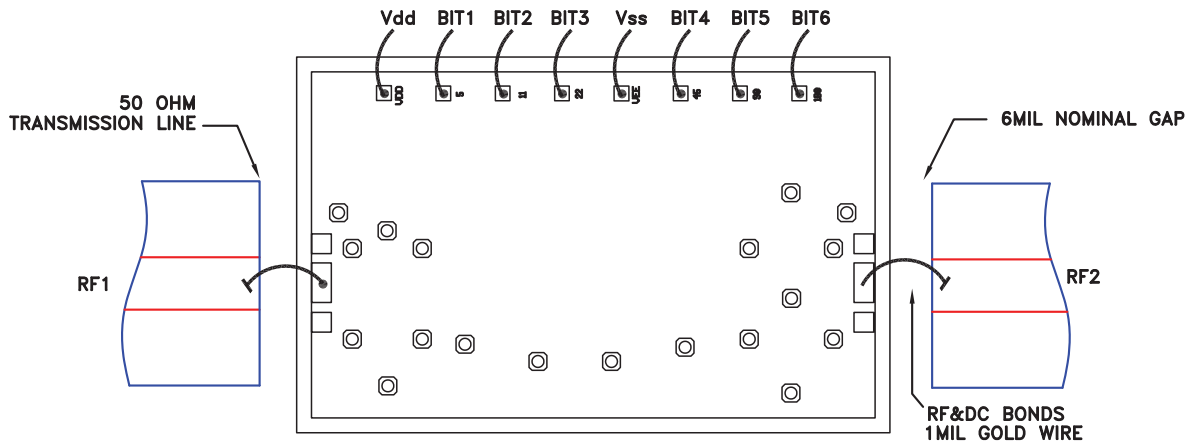
**GaAs MMIC 6-BIT DIGITAL
PHASE SHIFTER, 9 - 12.5 GHz**
Assembly Diagram

Handling Precautions

Follow these precautions to avoid permanent damage.

Storage: All bare die are placed in either Waffle or Gel based ESD protective containers, and then sealed in an ESD protective bag for shipment. Once the sealed ESD protective bag has been opened, all die should be stored in a dry nitrogen environment.

Cleanliness: Handle the chips in a clean environment. DO NOT attempt to clean the chip using liquid cleaning systems.

Static Sensitivity: Follow ESD precautions to protect against $\pm 250V$ ESD strikes.

Transients: Suppress instrument and bias supply transients while bias is applied. Use shielded signal and bias cables to minimize inductive pick-up.

General Handling: Handle the chip along the edges with a vacuum collet or with a sharp pair of bent tweezers. The surface of the chip has fragile air bridges and should not be touched with vacuum collet, tweezers, or fingers.

Mounting

The chip is back-metallized and can be die mounted with electrically conductive epoxy. The mounting surface should be clean and flat.

Epoxy Die Attach: Apply a minimum amount of epoxy to the mounting surface so that a thin epoxy fillet is observed around the perimeter of the chip once it is placed into position. Cure epoxy per the manufacturer's schedule.

Wire Bonding

Ball or wedge bond with 0.025mm (1 mil) diameter pure gold wire. Thermo-sonic wirebonding with a nominal stage temperature of 150 deg. C and a ball bonding force of 40 to 50 grams or wedge bonding force of 18 to 22 grams is recommended. Use the minimum level of ultrasonic energy to achieve reliable wirebonds. Wirebonds should be started on the chip and terminated on the package or substrate. All bonds should be as short as possible <0.31mm (12 mils).

Компания «Life Electronics» занимается поставками электронных компонентов импортного и отечественного производства от производителей и со складов крупных дистрибьюторов Европы, Америки и Азии.

С конца 2013 года компания активно расширяет линейку поставок компонентов по направлению коаксиальный кабель, кварцевые генераторы и конденсаторы (керамические, пленочные, электролитические), за счёт заключения дистрибьюторских договоров

Мы предлагаем:

- Конкурентоспособные цены и скидки постоянным клиентам.
- Специальные условия для постоянных клиентов.
- Подбор аналогов.
- Поставку компонентов в любых объемах, удовлетворяющих вашим потребностям.
- Приемлемые сроки поставки, возможна ускоренная поставка.
- Доставку товара в любую точку России и стран СНГ.
- Комплексную поставку.
- Работу по проектам и поставку образцов.
- Формирование склада под заказчика.
- Сертификаты соответствия на поставляемую продукцию (по желанию клиента).
- Тестирование поставляемой продукции.
- Поставку компонентов, требующих военную и космическую приемку.
- Входной контроль качества.
- Наличие сертификата ISO.

В составе нашей компании организован Конструкторский отдел, призванный помогать разработчикам, и инженерам.

Конструкторский отдел помогает осуществить:

- Регистрацию проекта у производителя компонентов.
- Техническую поддержку проекта.
- Защиту от снятия компонента с производства.
- Оценку стоимости проекта по компонентам.
- Изготовление тестовой платы монтаж и пусконаладочные работы.



Тел: +7 (812) 336 43 04 (многоканальный)

Email: org@lifeelectronics.ru