

Trench gate field-stop IGBT, HB series 650 V, 20 A high speed

Datasheet - production data

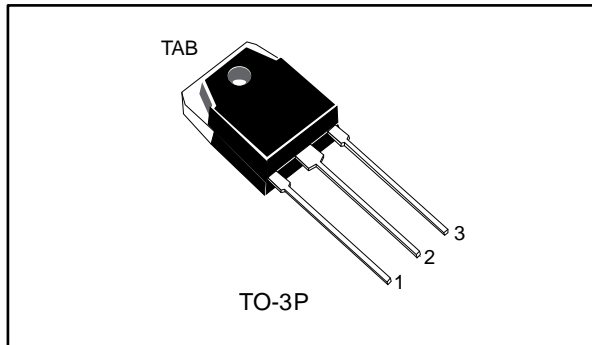
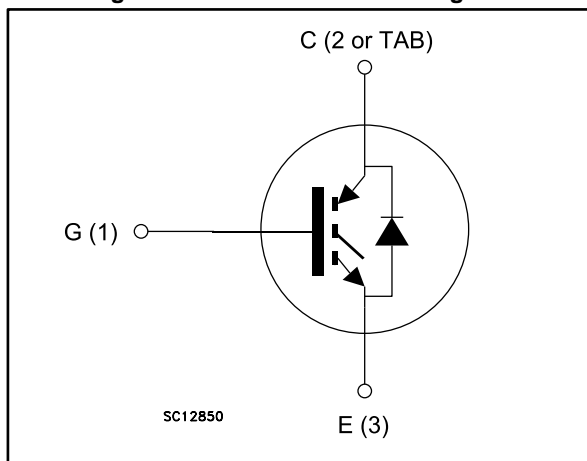

Figure 1: Internal schematic diagram



Features

- Maximum junction temperature: $T_J = 175\text{ °C}$
- Minimized tail current
- $V_{CE(sat)} = 1.55\text{ V (typ.) @ } I_C = 20\text{ A}$
- Tight parameter distribution
- Co-packed diode for protection
- Safe paralleling
- Low thermal resistance

Applications

- Power factor corrector (PFC)

Description

This device is an IGBT developed using an advanced proprietary trench gate field-stop structure. The device is part of the new HB series of IGBTs, which represents an optimum compromise between conduction and switching loss to maximize the efficiency of any frequency converter. Furthermore, the slightly positive $V_{CE(sat)}$ temperature coefficient and very tight parameter distribution result in safer paralleling operation.

Table 1: Device summary

Order code	Marking	Package	Packing
STGWT20HP65FB	GWT20HP65FB	TO-3P	Tube

Contents

1	Electrical ratings	3
2	Electrical characteristics	4
	2.1 Electrical characteristics (curves)	6
3	Test circuits	10
4	Package information	11
	4.1 TO-3P package information	12
5	Revision history	14

1 Electrical ratings

Table 2: Absolute maximum ratings

Symbol	Parameter	Value	Unit
V_{CES}	Collector-emitter voltage ($V_{GE} = 0$ V)	650	V
I_C	Continuous collector current at $T_C = 25$ °C	40	A
	Continuous collector current at $T_C = 100$ °C	20	
$I_{CP}^{(1)}$	Pulsed collector current	80	A
V_{GE}	Gate-emitter voltage	± 20	V
I_F	Continuous forward current at $T_C = 25$ °C ⁽²⁾	5	A
	Continuous forward current at $T_C = 100$ °C	5	
$I_{FP}^{(3)}$	Pulsed forward current	10	A
P_{TOT}	Total dissipation at $T_C = 25$ °C	168	W
T_{STG}	Storage temperature range	-55 to 150	°C
T_J	Operating junction temperature range	-55 to 175	

Notes:

(1) Pulse width limited by maximum junction temperature

(2) Limited by wires

(3) Pulsed forward current

Table 3: Thermal data

Symbol	Parameter	Value	Unit
R_{thJC}	Thermal resistance junction-case IGBT	0.9	°C/W
R_{thJC}	Thermal resistance junction-case diode	5	
R_{thJA}	Thermal resistance junction-ambient	50	

2 Electrical characteristics

$T_J = 25\text{ °C}$ unless otherwise specified

Table 4: Static characteristics

Symbol	Parameter	Test conditions	Min.	Typ.	Max.	Unit
$V_{(BR)CES}$	Collector-emitter breakdown voltage	$V_{GE} = 0\text{ V}$, $I_C = 2\text{ mA}$	650			V
$V_{CE(sat)}$	Collector-emitter saturation voltage	$V_{GE} = 15\text{ V}$, $I_C = 20\text{ A}$		1.55	2.0	V
		$V_{GE} = 15\text{ V}$, $I_C = 20\text{ A}$, $T_J = 125\text{ °C}$		1.65		
		$V_{GE} = 15\text{ V}$, $I_C = 20\text{ A}$, $T_J = 175\text{ °C}$		1.75		
V_F	Forward on-voltage	$I_F = 5\text{ A}$		2		V
		$I_F = 5\text{ A}$, $T_J = 125\text{ °C}$		1.85		
		$I_F = 5\text{ A}$, $T_J = 175\text{ °C}$		1.75		
$V_{GE(th)}$	Gate threshold voltage	$V_{CE} = V_{GE}$, $I_C = 1\text{ mA}$	5	6	7	V
I_{CES}	Collector cut-off current	$V_{GE} = 0\text{ V}$, $V_{CE} = 650\text{ V}$			25	μA
I_{GES}	Gate-emitter leakage current	$V_{CE} = 0\text{ V}$, $V_{GE} = \pm 20\text{ V}$			± 250	nA

Table 5: Dynamic characteristics

Symbol	Parameter	Test conditions	Min.	Typ.	Max.	Unit
C_{ies}	Input capacitance	$V_{CE} = 25\text{ V}$, $f = 1\text{ MHz}$, $V_{GE} = 0\text{ V}$	-	2764	-	pF
C_{oes}	Output capacitance		-	80	-	
C_{res}	Reverse transfer capacitance		-	60	-	
Q_g	Total gate charge	$V_{CC} = 520\text{ V}$, $I_C = 20\text{ A}$, $V_{GE} = 15\text{ V}$ (see Figure 27: "Gate charge test circuit")	-	120	-	nC
Q_{ge}	Gate-emitter charge		-	20	-	
Q_{gc}	Gate-collector charge		-	50	-	

Table 6: IGBT switching characteristics (inductive load)

Symbol	Parameter	Test conditions	Min.	Typ.	Max.	Unit
$t_{d(off)}$	Turn-off delay time	$V_{CE} = 400\text{ V}$, $I_C = 20\text{ A}$, $V_{GE} = 15\text{ V}$, $R_G = 10\ \Omega$ (see Figure 26: "Test circuit for inductive load switching")	-	139	-	ns
t_f	Current fall time		-	20	-	ns
$E_{off}^{(1)}$	Turn-off switching energy		-	170	-	μJ
$t_{d(off)}$	Turn-off-delay time	$V_{CE} = 400\text{ V}$, $I_C = 20\text{ A}$, $V_{GE} = 15\text{ V}$, $R_G = 10\ \Omega$, $T_J = 175\text{ °C}$ (see Figure 26: "Test circuit for inductive load switching")	-	147	-	ns
t_f	Current fall time		-	38	-	ns
$E_{off}^{(1)}$	Turn-off switching energy		-	353	-	μJ

Notes:

⁽¹⁾Including the tail of the collector current

Table 7: Diode switching characteristics (inductive load)

Symbol	Parameter	Test conditions	Min.	Typ.	Max.	Unit
t_{rr}	Reverse recovery time	$I_F = 5\text{ A}$, $V_R = 400\text{ V}$, $V_{GE} = 15\text{ V}$, $di/dt = 1000\text{ A}/\mu\text{s}$ (see Figure 26: "Test circuit for inductive load switching")	-	140	-	ns
Q_{rr}	Reverse recovery charge		-	21	-	nC
I_{rrm}	Reverse recovery current		-	6.6	-	A
dl_{rr}/dt	Peak rate of fall of reverse recovery current during t_b		-	430	-	A/ μs
E_{rr}	Reverse recovery energy		-	1.6	-	μJ
t_{rr}	Reverse recovery time	$I_F = 5\text{ A}$, $V_R = 400\text{ V}$, $V_{GE} = 15\text{ V}$, $T_J = 175\text{ }^\circ\text{C}$, $di/dt = 1000\text{ A}/\mu\text{s}$ (see Figure 26: "Test circuit for inductive load switching")	-	200	-	ns
Q_{rr}	Reverse recovery charge		-	47.3	-	nC
I_{rrm}	Reverse recovery current		-	9.6	-	A
dl_{rr}/dt	Peak rate of fall of reverse recovery current during t_b		-	428	-	A/ μs
E_{rr}	Reverse recovery energy		-	3.2	-	μJ

2.1 Electrical characteristics (curves)

Figure 2: Output characteristics ($T_J = 25\text{ }^\circ\text{C}$)

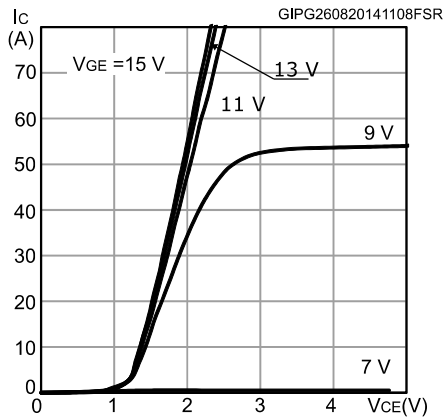

Figure 3: Output characteristics ($T_J = 175\text{ }^\circ\text{C}$)

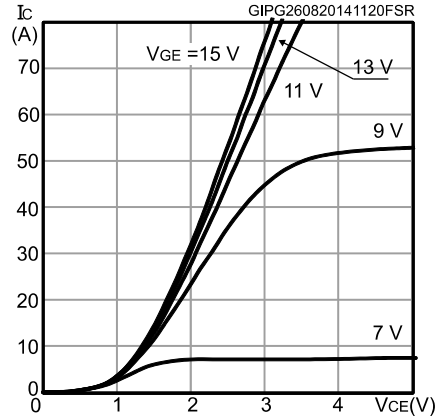

Figure 4: Transfer characteristics

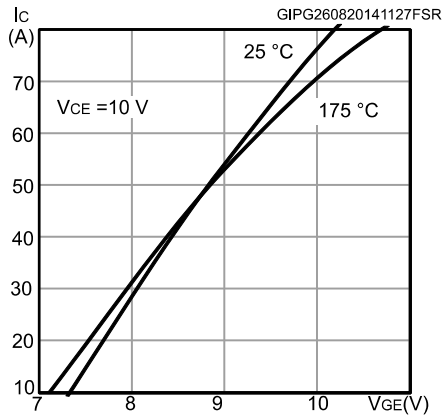

Figure 5: Collector current vs. case temperature

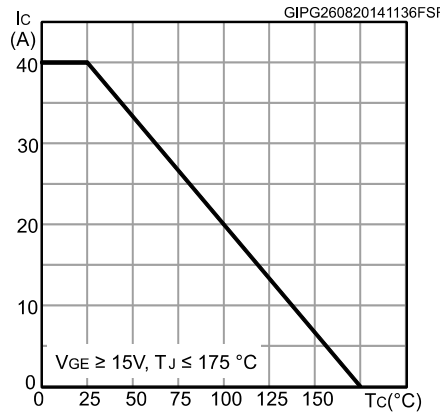

Figure 6: $V_{CE(sat)}$ vs. junction temperature

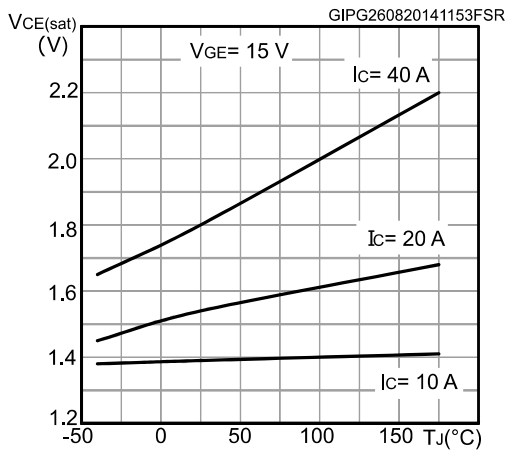

Figure 7: Power dissipation vs. case temperature

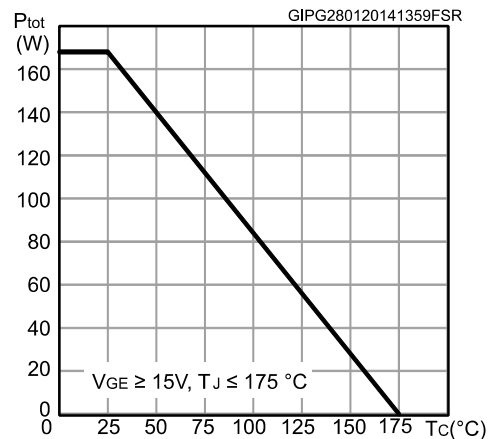

Figure 8: Forward bias safe operating area

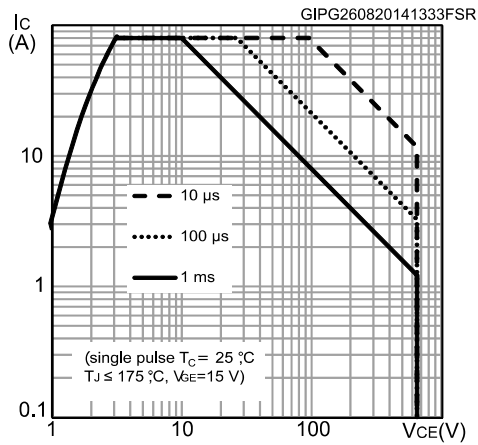

Figure 9: Collector current vs. switching frequency

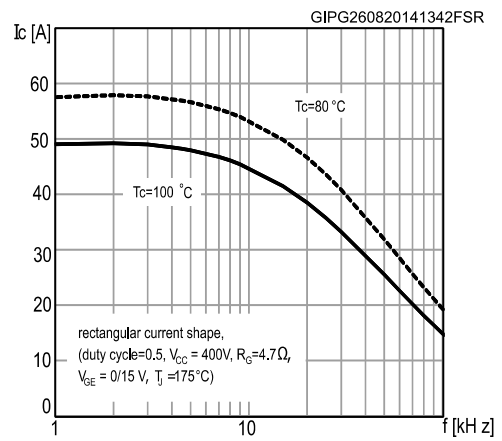

Figure 10: Normalized $V_{GE(th)}$ vs. junction temperature

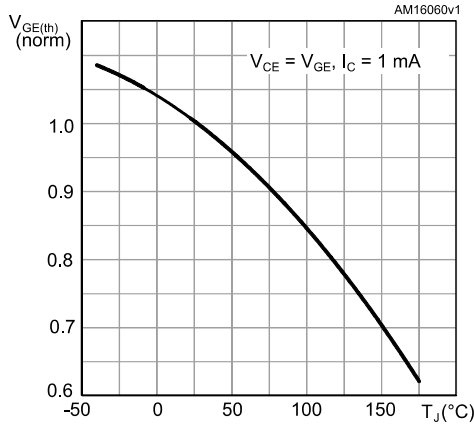

Figure 11: Normalized $V_{(BR)CES}$ vs. junction temperature

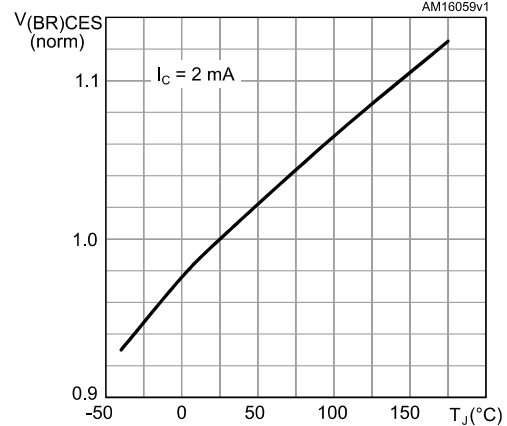

Figure 12: Switching energy vs. collector current

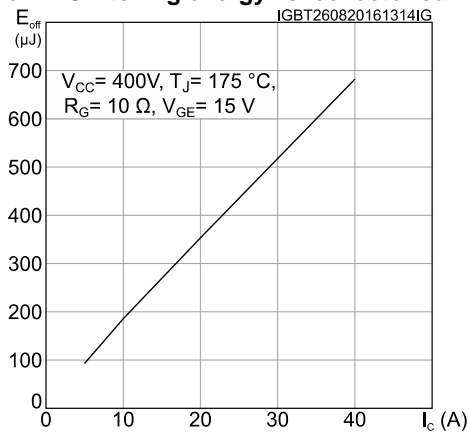

Figure 13: Switching energy vs. gate resistance

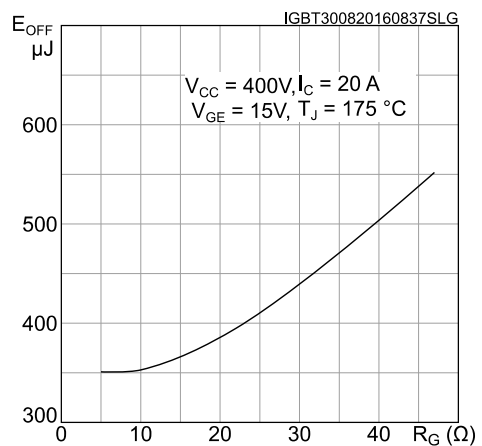

Figure 14: Switching energy vs. temperature

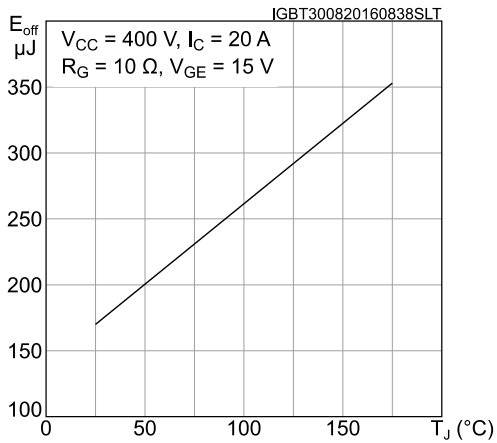

Figure 15: Switching energy vs. collector emitter voltage

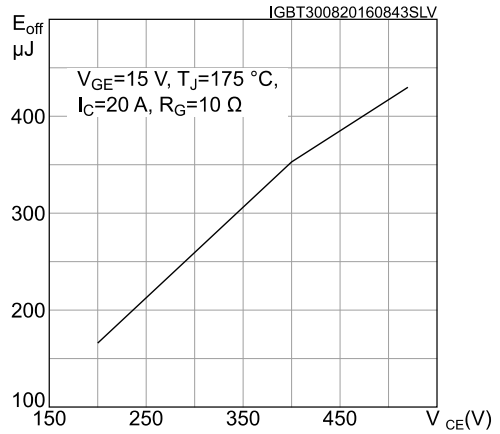

Figure 16: Switching times vs. collector current

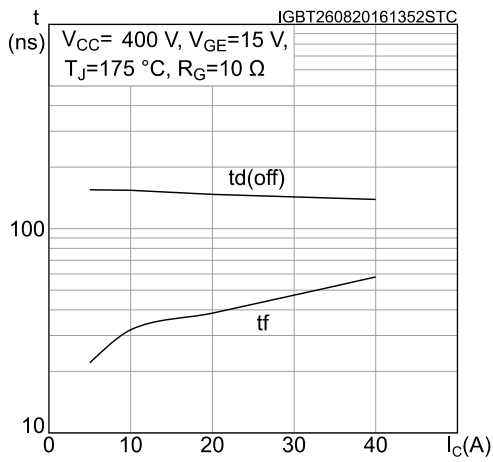

Figure 17: Switching time vs. gate resistance

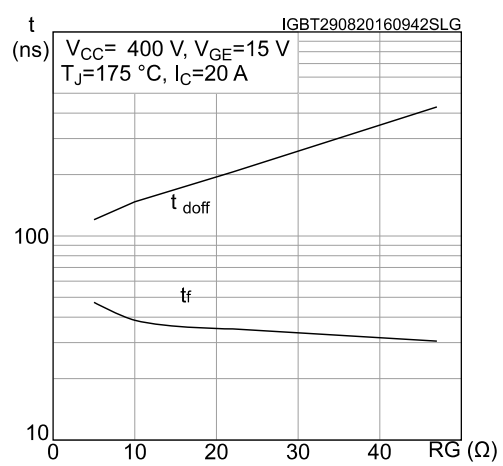

Figure 18: Capacitance variations

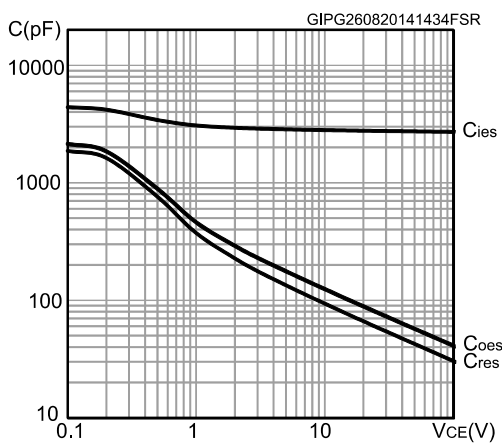
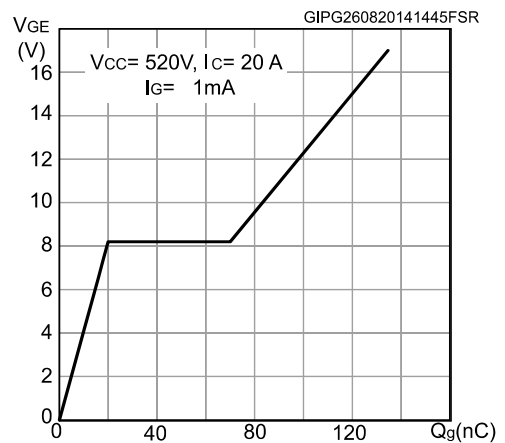
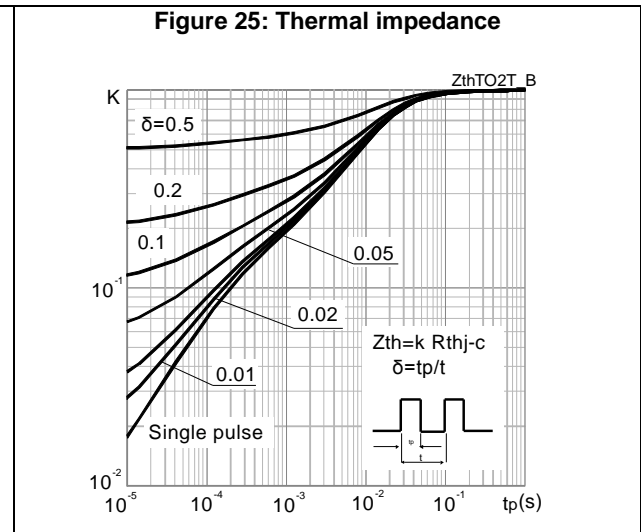
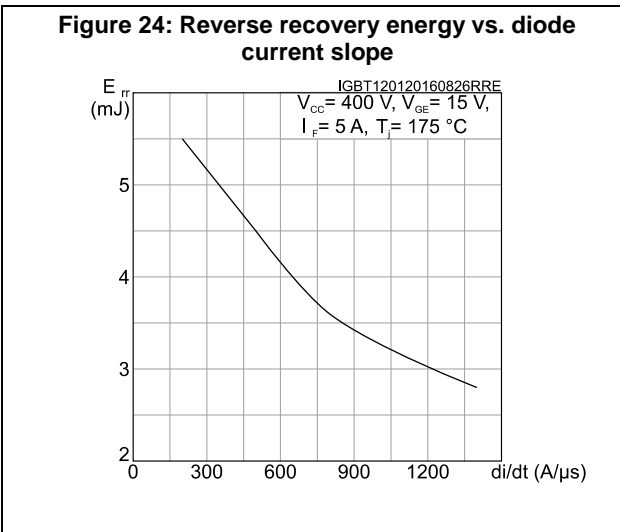
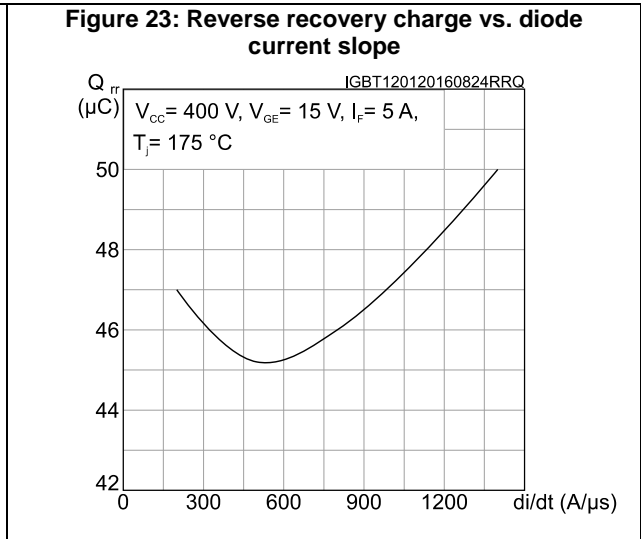
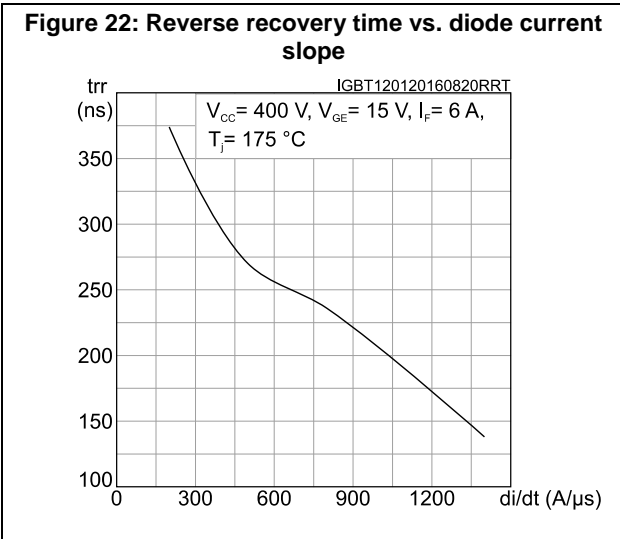
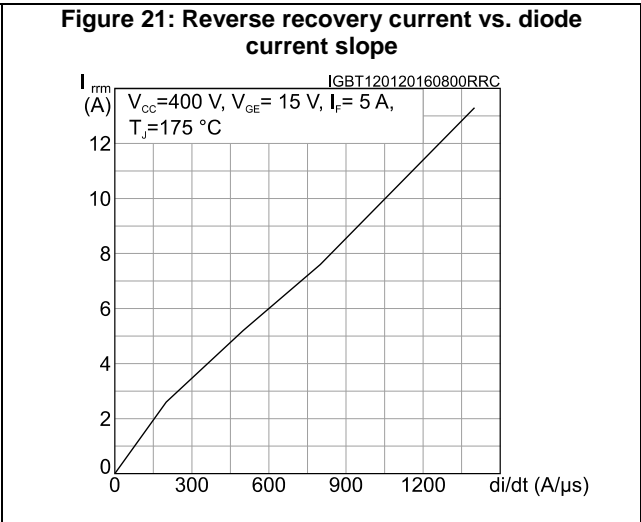
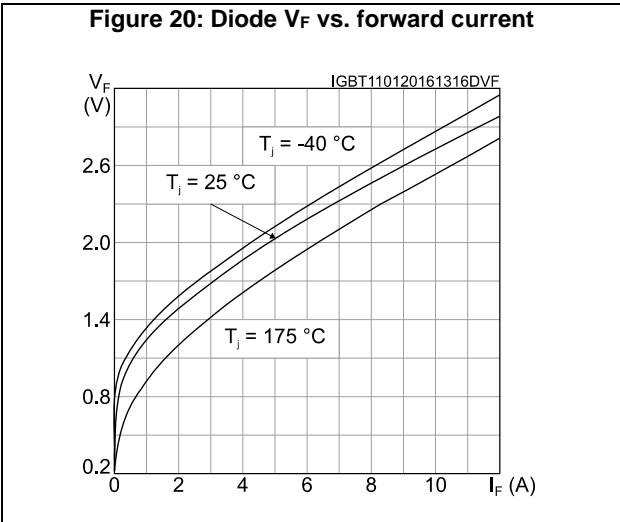

Figure 19: Gate charge vs. gate-emitter voltage





3 Test circuits

Figure 26: Test circuit for inductive load switching

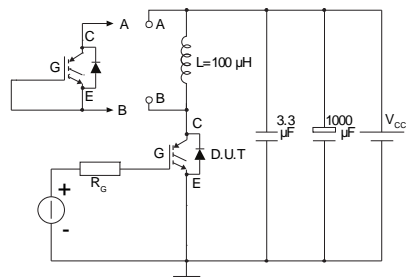

AM01504v1

Figure 27: Gate charge test circuit

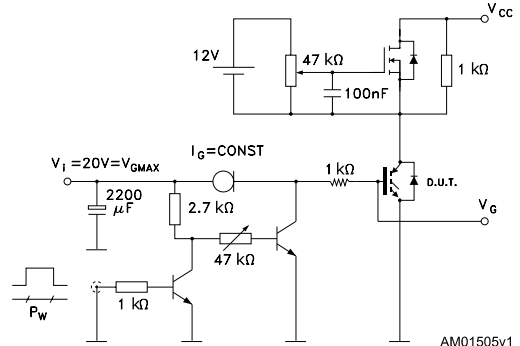

AM01505v1

Figure 28: Switching waveform

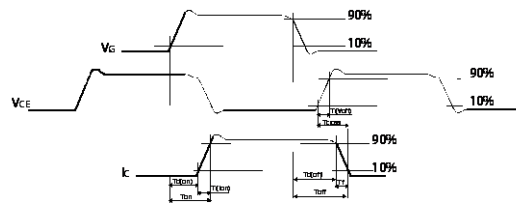

AM01506v1

4 Package information

In order to meet environmental requirements, ST offers these devices in different grades of ECOPACK® packages, depending on their level of environmental compliance. ECOPACK® specifications, grade definitions and product status are available at: www.st.com. ECOPACK® is an ST trademark.

4.1 TO-3P package information

Figure 29: TO-3P package outline

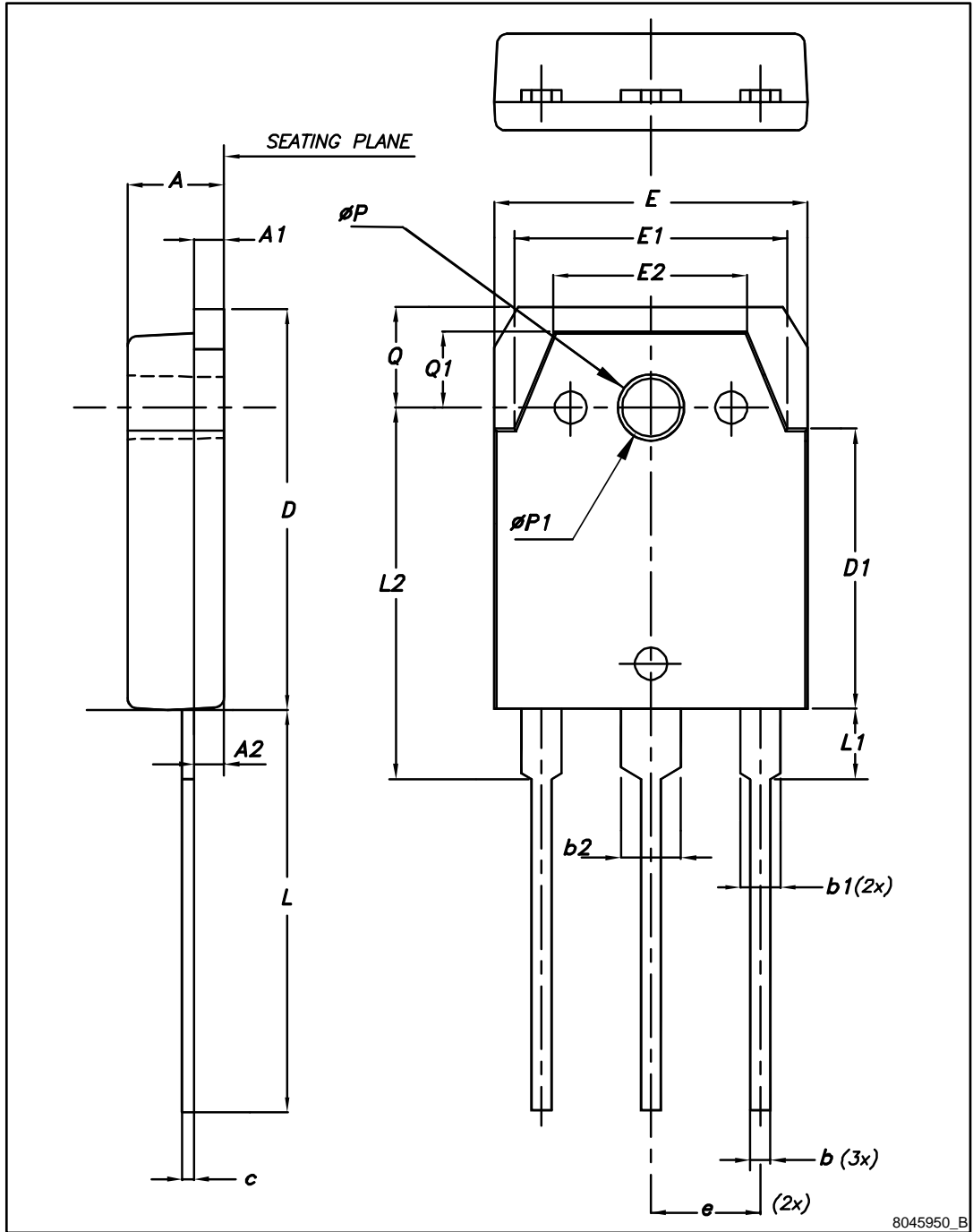

8045950_B

Table 8: TO-3P package mechanical data

Dim.	mm		
	Min.	Typ.	Max.
A	4.60	4.80	5.00
A1	1.45	1.50	1.65
A2	1.20	1.40	1.60
b	0.80	1.00	1.20
b1	1.80	2.00	2.20
b2	2.80	3.00	3.20
c	0.55	0.60	0.75
D	19.70	19.90	20.10
D1	13.70	13.90	14.10
E	15.40	15.60	15.80
E1	13.40	13.60	13.80
E2	9.40	9.60	9.90
e	5.15	5.45	5.75
L	19.80	20.00	20.20
L1	3.30	3.50	3.70
L2	18.20	18.40	18.60
ØP	3.30	3.40	3.50
ØP1	3.10	3.20	3.30
Q	4.80	5.00	5.20
Q1	3.60	3.80	4

5 Revision history

Table 9: Document revision history

Date	Revision	Changes
31-Aug-2016	1	First release.
28-Sep-2016	2	Datasheet promoted from preliminary to production data.
13-Dec-2016	3	<p>Updated Figure 1: "Internal schematic diagram".</p> <p>Updated Table 4: "Static characteristics" and Table 7: "Diode switching characteristics (inductive load)".</p> <p>Added Figure 20: "Diode VF vs. forward current", Figure 21: "Reverse recovery current vs. diode current slope", Figure 22: "Reverse recovery time vs. diode current slope", Figure 23: "Reverse recovery charge vs. diode current slope" and Figure 24: "Reverse recovery energy vs. diode current slope".</p> <p>Updated Figure 2: "Output characteristics (TJ = 25 °C)", Figure 12: "Switching energy vs. collector current" and Figure 17: "Switching time vs. gate resistance".</p> <p>Minor text changes</p>

IMPORTANT NOTICE – PLEASE READ CAREFULLY

STMicroelectronics NV and its subsidiaries ("ST") reserve the right to make changes, corrections, enhancements, modifications, and improvements to ST products and/or to this document at any time without notice. Purchasers should obtain the latest relevant information on ST products before placing orders. ST products are sold pursuant to ST's terms and conditions of sale in place at the time of order acknowledgement.

Purchasers are solely responsible for the choice, selection, and use of ST products and ST assumes no liability for application assistance or the design of Purchasers' products.

No license, express or implied, to any intellectual property right is granted by ST herein.

Resale of ST products with provisions different from the information set forth herein shall void any warranty granted by ST for such product.

ST and the ST logo are trademarks of ST. All other product or service names are the property of their respective owners.

Information in this document supersedes and replaces information previously supplied in any prior versions of this document.

© 2016 STMicroelectronics – All rights reserved

Компания «Life Electronics» занимается поставками электронных компонентов импортного и отечественного производства от производителей и со складов крупных дистрибьюторов Европы, Америки и Азии.

С конца 2013 года компания активно расширяет линейку поставок компонентов по направлению коаксиальный кабель, кварцевые генераторы и конденсаторы (керамические, пленочные, электролитические), за счёт заключения дистрибьюторских договоров

Мы предлагаем:

- Конкуренспособные цены и скидки постоянным клиентам.
- Специальные условия для постоянных клиентов.
- Подбор аналогов.
- Поставку компонентов в любых объемах, удовлетворяющих вашим потребностям.
- Приемлемые сроки поставки, возможна ускоренная поставка.
- Доставку товара в любую точку России и стран СНГ.
- Комплексную поставку.
- Работу по проектам и поставку образцов.
- Формирование склада под заказчика.
- Сертификаты соответствия на поставляемую продукцию (по желанию клиента).
- Тестирование поставляемой продукции.
- Поставку компонентов, требующих военную и космическую приемку.
- Входной контроль качества.
- Наличие сертификата ISO.

В составе нашей компании организован Конструкторский отдел, призванный помогать разработчикам, и инженерам.

Конструкторский отдел помогает осуществить:

- Регистрацию проекта у производителя компонентов.
- Техническую поддержку проекта.
- Защиту от снятия компонента с производства.
- Оценку стоимости проекта по компонентам.
- Изготовление тестовой платы монтаж и пусконаладочные работы.



Тел: +7 (812) 336 43 04 (многоканальный)

Email: org@lifeelectronics.ru