

ALISE-70-WW

~60° wide beam

TECHNICAL SPECIFICATIONS:

Dimensions	Ø 70.0 x mm
Height	42 mm
Fastening	
Colour	metal
Box size	410 x 335 x 200 mm
Box weight	0 kg
Quantity in Box	500 pcs
ROHS compliant	yes ⓘ





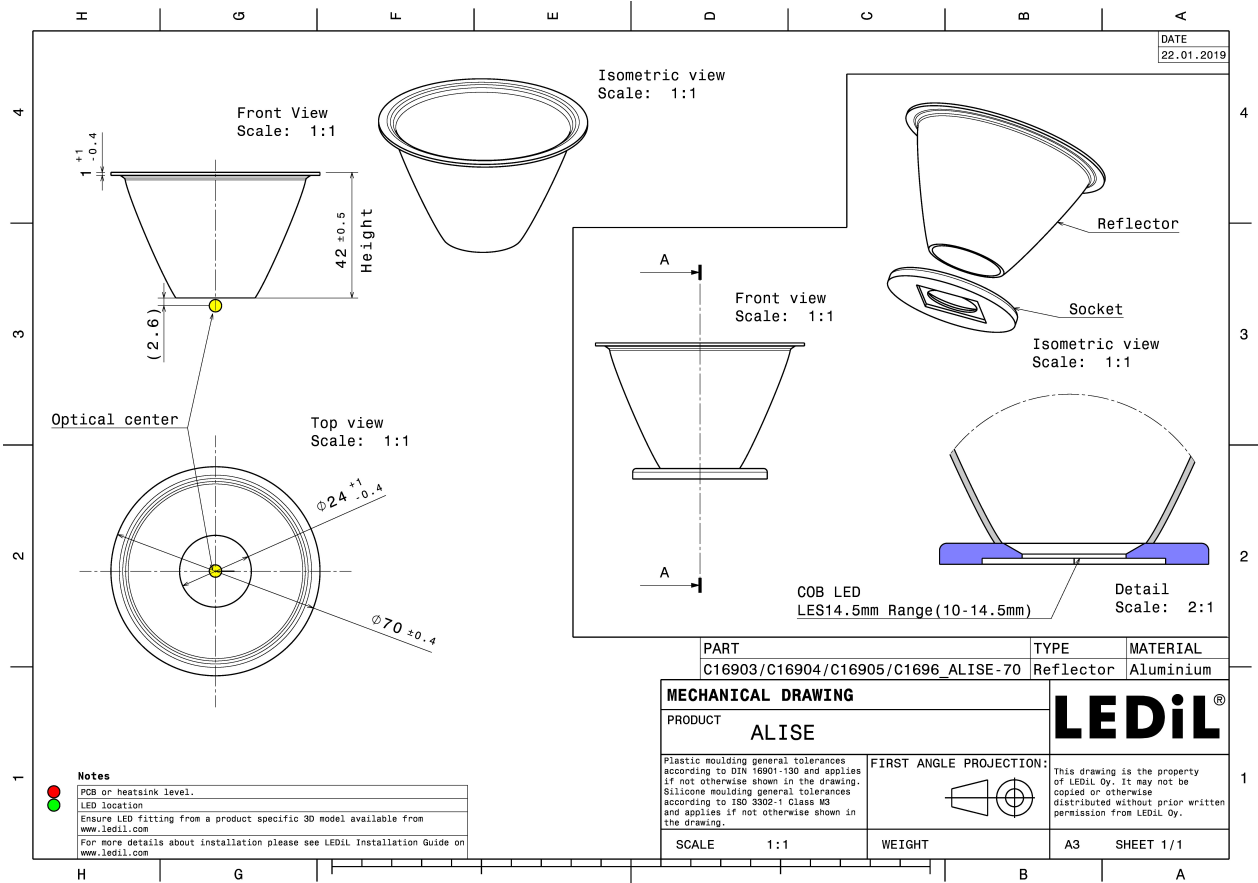

MATERIAL SPECIFICATIONS:

Component	Type	Material	Colour	Coating
ALISE-70-WW	Reflector	Aluminium	metal	Anodized

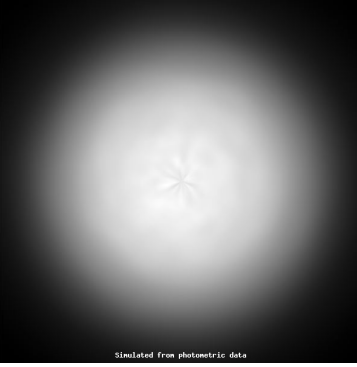
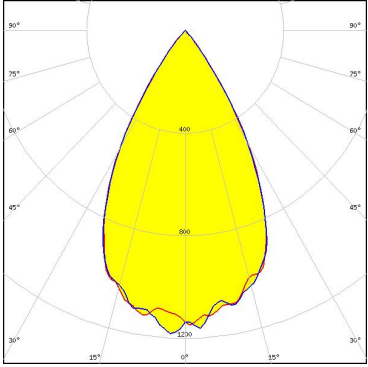
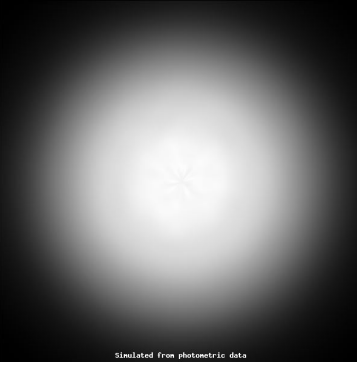
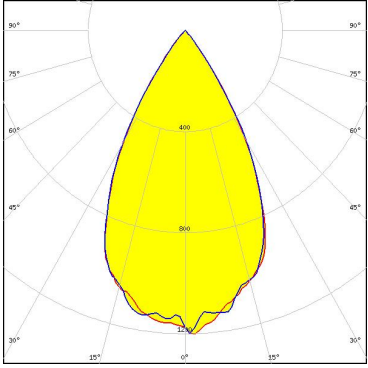

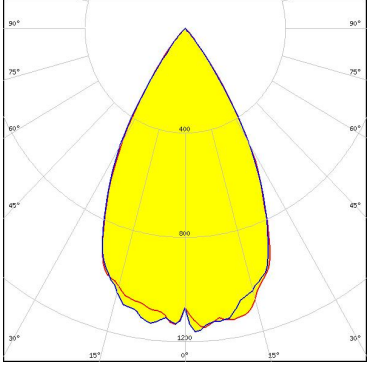
PHOTOMETRIC DATA (SIMULATED):

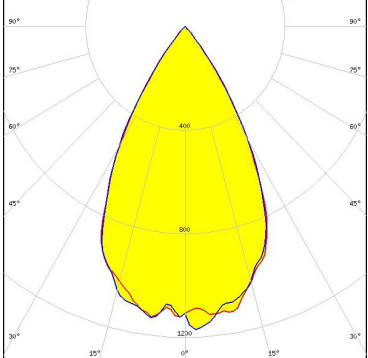
<p> bridgelux</p> <p>LED V13 Gen7 FWHM 58.0° Efficiency 92 % Peak intensity 1.184 cd/lm LEDs/each optic 1 Light colour White Required components:</p>	 <p style="text-align: center; font-size: small;">Simulated from photometric data</p>	
<p>CITIZEN</p> <p>LED CLL03x/CLU03x FWHM 56.0° Efficiency 91 % Peak intensity 1.210 cd/lm LEDs/each optic 1 Light colour White Required components:</p>	 <p style="text-align: center; font-size: small;">Simulated from photometric data</p>	
<p> LUMILEDS</p> <p>LED LUXEON CoB 1204/1205 FWHM 58.0° Efficiency 92 % Peak intensity 1.192 cd/lm LEDs/each optic 1 Light colour White Required components:</p>	 <p style="text-align: center; font-size: small;">Simulated from photometric data</p>	
<p> LUMILEDS</p> <p>LED LUXEON CoB 1208 FWHM 58.0° Efficiency 91 % Peak intensity 1.254 cd/lm LEDs/each optic 1 Light colour White Required components:</p>	 <p style="text-align: center; font-size: small;">Simulated from photometric data</p>	

PHOTOMETRIC DATA (SIMULATED):

SAMSUNG

LED COB D Series LES 14.5 mm
FWHM 57.0°
Efficiency 91 %
Peak intensity 1.202 cd/lm
LEDs/each optic 1
Light colour White
Required components:

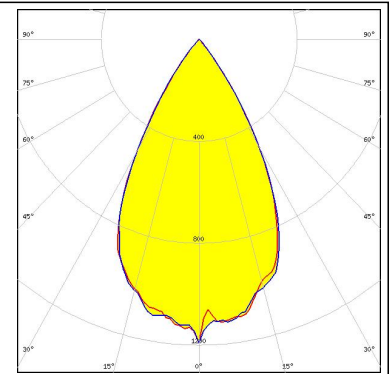
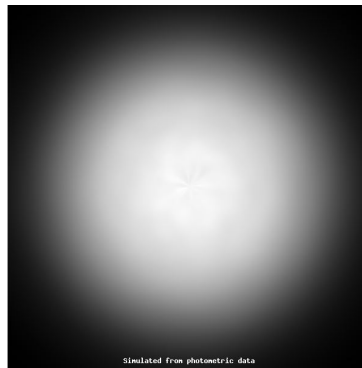

GENERAL INFORMATION:

NOTE: The typical beam angle will be changed by different color, chip size and chip position tolerance. The typical total beam angle is the full angle measured where the luminous intensity is half of the peak value.

Due to use of high power COB's with this product, special attention to proper thermal design is highly recommended. LEDiL has no liability for direct, indirect or consecutive damages arising from the LEDiL products being used outside of the recommended temperature range.

MATERIALS:

As part of our continuous research and improvement processes, and to ensure the best possible quality and availability of our products, LEDiL reserves the right to change material grades without notice.

PRODUCT DATA USER AGREEMENT AND DISCLAIMER:

The measured data in the provided downloadable LEDiL Product Datasheets and Mechanical 2D-Drawings is rounded and provided as reference for planning. LEDiL Oy's optical specifications have been verified by conducting performance testing of the products in accordance with the company's quality system. The reported data are averaged results of multiple measurements with typical variation. LEDiL Oy reserves the right to without prior notification make changes and improvements to its products.

LEDiL Oy assumes neither warranty, nor guarantee nor any other liability of any kind for the contents and correctness of the provided data. The provided data has been generated with highest diligence but the provided data may in reality not represent the complete possible variation range of all intrinsic parameters. Therefore, in certain cases a deviation from the provided data could occur.

LEDiL Oy reserves the right to undertake technical changes of its products without further notification which could lead to changes in the provided data. LEDiL Oy assumes no liability of any kind for the possible deviation from any provided data or any other damage resulting from the usage of the provided data.

The user agrees to this disclaimer and user agreement with the download or usage of the provided files.

LEDiL Oy

Joensuunkatu 13
FI-24240 SALO
Finland

LEDiL Inc.

228 West Page Street
Suite D
Sycamore IL 60178
USA

Local sales and technical support

www.ledil.com/where_to_buy

Shipping locations

Salo, Finland
Hong Kong, China

Distribution Partners

www.ledil.com/where_to_buy

Компания «Life Electronics» занимается поставками электронных компонентов импортного и отечественного производства от производителей и со складов крупных дистрибьюторов Европы, Америки и Азии.

С конца 2013 года компания активно расширяет линейку поставок компонентов по направлению коаксиальный кабель, кварцевые генераторы и конденсаторы (керамические, пленочные, электролитические), за счёт заключения дистрибьюторских договоров

Мы предлагаем:

- Конкурентоспособные цены и скидки постоянным клиентам.
- Специальные условия для постоянных клиентов.
- Подбор аналогов.
- Поставку компонентов в любых объемах, удовлетворяющих вашим потребностям.
- Приемлемые сроки поставки, возможна ускоренная поставка.
- Доставку товара в любую точку России и стран СНГ.
- Комплексную поставку.
- Работу по проектам и поставку образцов.
- Формирование склада под заказчика.
- Сертификаты соответствия на поставляемую продукцию (по желанию клиента).
- Тестирование поставляемой продукции.
- Поставку компонентов, требующих военную и космическую приемку.
- Входной контроль качества.
- Наличие сертификата ISO.

В составе нашей компании организован Конструкторский отдел, призванный помогать разработчикам, и инженерам.

Конструкторский отдел помогает осуществить:

- Регистрацию проекта у производителя компонентов.
- Техническую поддержку проекта.
- Защиту от снятия компонента с производства.
- Оценку стоимости проекта по компонентам.
- Изготовление тестовой платы монтаж и пусконаладочные работы.



Тел: +7 (812) 336 43 04 (многоканальный)
Email: org@lifeelectronics.ru