

# JS Series Sub-Miniature Slide Switches

## Features/Benefits

- Positive detent
- Low profile
- IR reflow to 260° solder profile
- Surface and thru hole mounting
- SPDT, DPDT, DP3T models
- RoHS compliant

## Typical Applications

- Telecommunication products
- Computer peripherals
- Thermostat select switch
- Instrumentations



## Specifications

CONTACT RATING: 6 VDC @ 0.3A  
 ELECTRICAL LIFE: 5,000 make-and-break cycles  
 CONTACT RESISTANCE: 70 m Ω max.  
 INSULATION RESISTANCE: 100 M Ω min. @ 500V.  
 DIELECTRIC STRENGTH: 500 VAC min. @ sea level.  
 OPERATING TEMPERATURE: -40°C to +85°C  
 STORAGE TEMPERATURE: -40°C to +85°C

**NOTE:** Specifications and materials listed above are for switches with standard options.  
 For information on specific and custom switches, consult Customer Service Center.

## Materials

HOUSING: 4/6 nylon (UL94V-2), black.  
 ACTUATOR: 4/6 nylon (UL94V-2), black (some options white).  
 CONTACTS: Copper alloy, silver plated.  
 TERMINALS: Brass, silver plated



Slide

## RIGHT ANGLE, PC THRU-HOLE

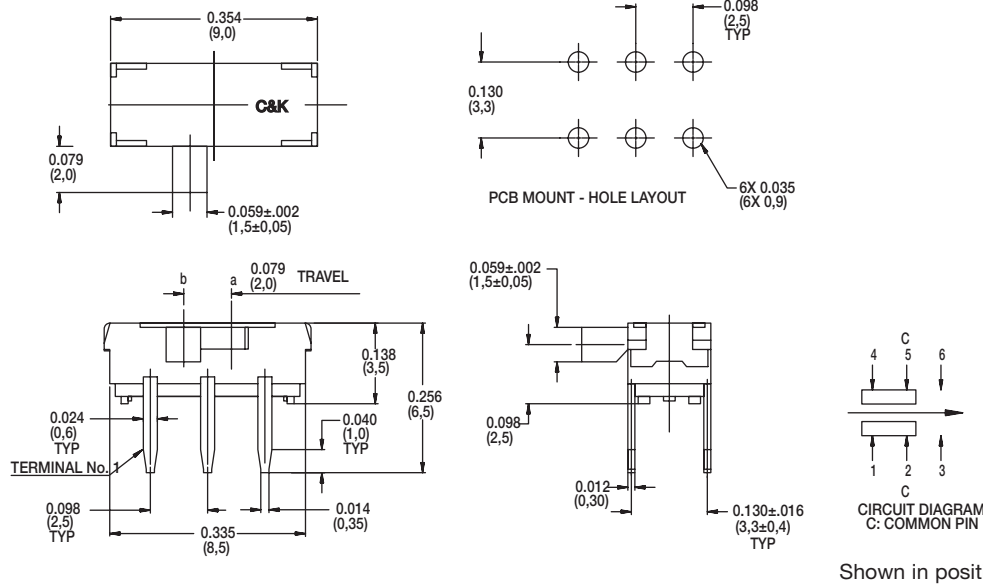

# JS Series Sub-Miniature Slide Switches

## RIGHT ANGLE, PC THRU-HOLE

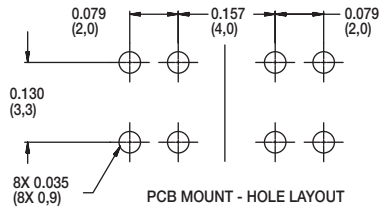
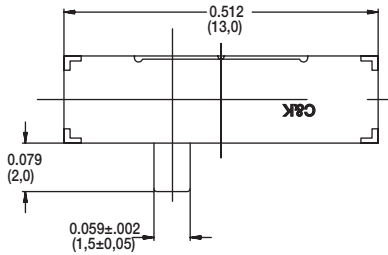

Part Number  
JS203011AQN  
**DP3T**

Shown in position b

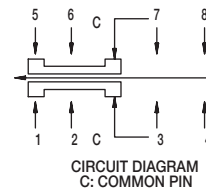
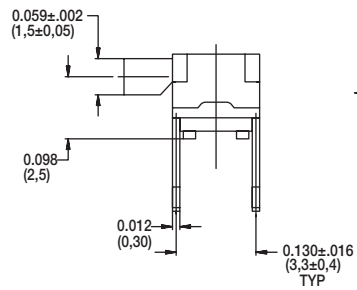
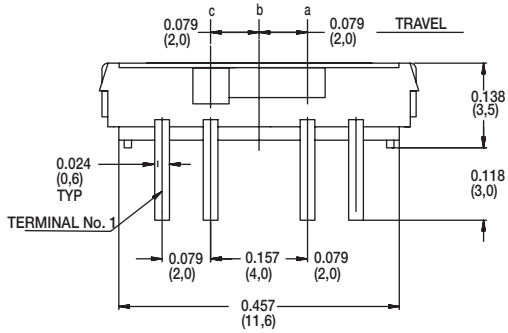

CIRCUIT DIAGRAM  
C: COMMON PIN

Shown in position c

## PC THRU-HOLE

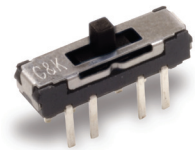
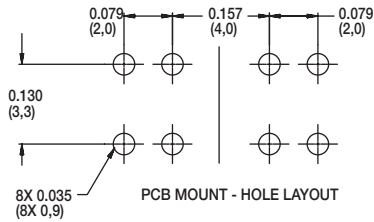
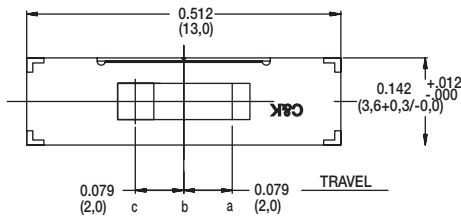

Part Number  
JS203011CQN  
**DP3T**

Shown in position b

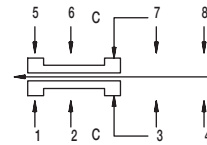
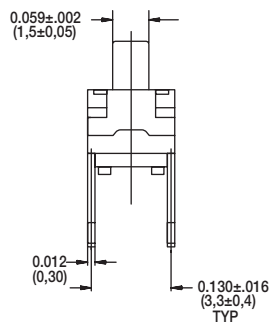
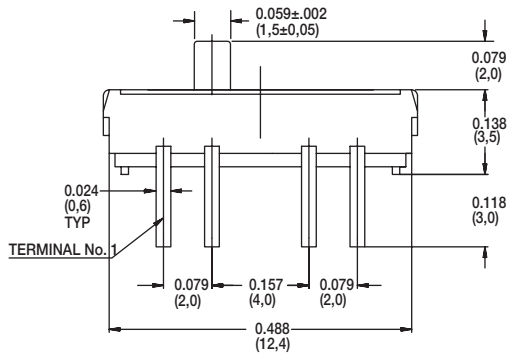

CIRCUIT DIAGRAM  
C: COMMON PIN

Shown in position c



Third Angle  
Projection

Dimensions are shown: Inch (mm)  
Specifications and dimensions subject to change

Slide

# JS Series Sub-Miniature Slide Switches

## PC THRU-HOLE

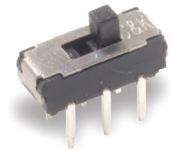

Part Number  
JS202011CQN  
DPDT

Shown in position a



Slide

## SURFACE MOUNT

Part number  
JS202011SCQN  
DPDT

Shown in position b. Quantity per reel 1000  
Available in tape & reel only, see page I-58

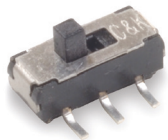
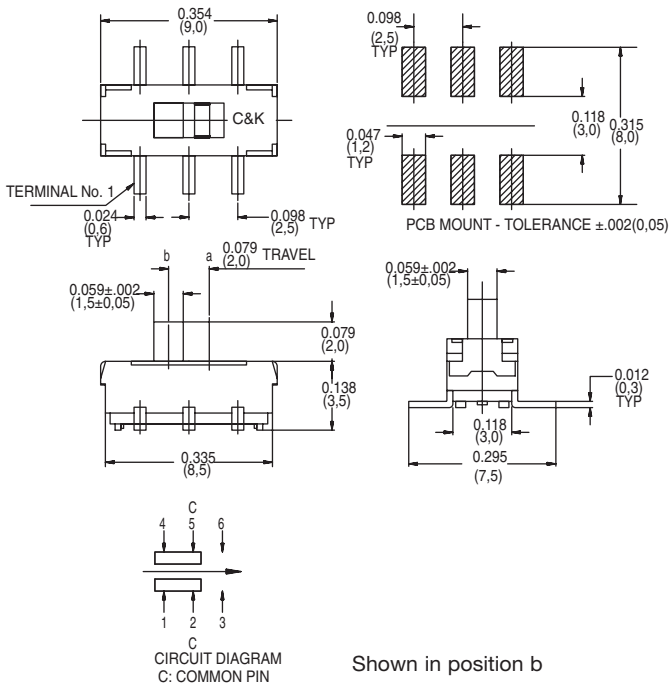

Part number  
JS203011SCQN  
DP3T

Quantity per reel 900  
Available in tape & reel only, see page I-60

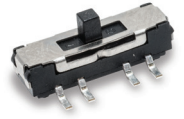
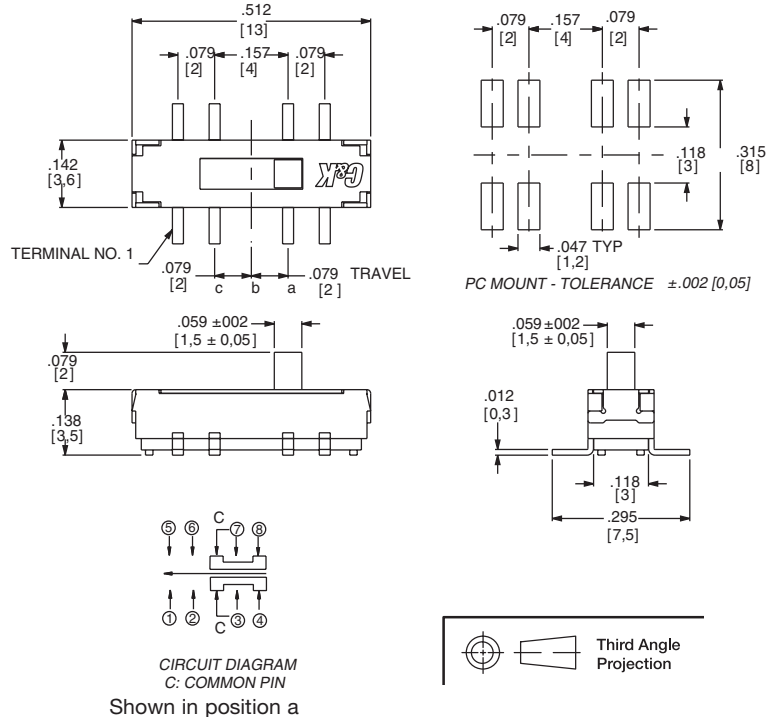

# JS Series Sub-Miniature Slide Switches

## RIGHT ANGLE SURFACE MOUNT

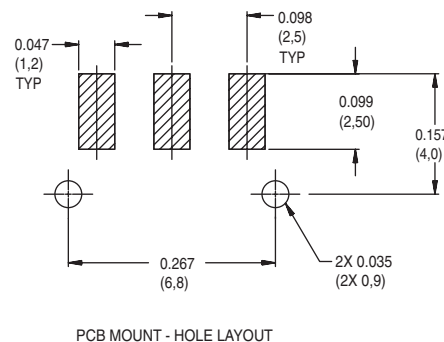
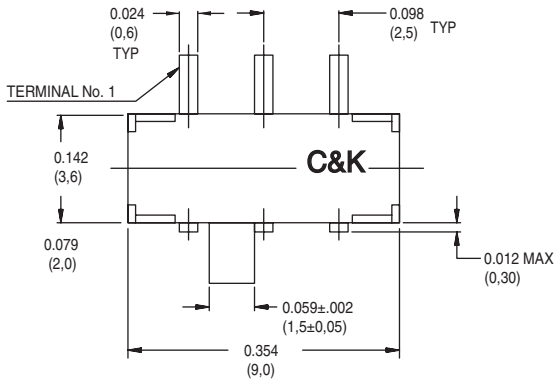

Part Number  
JS102011SAQN  
SPDT

Shown in position a

Available in tape & reel only, see page I-59

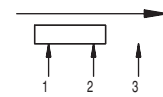
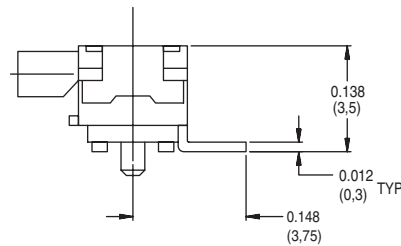
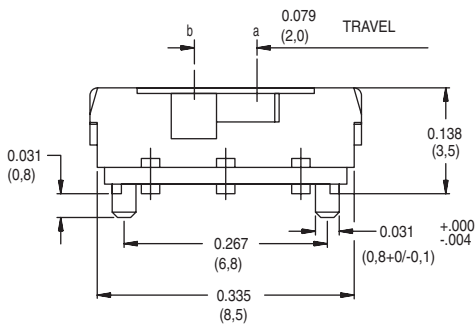

Shown in position b

## PC THRU-HOLE

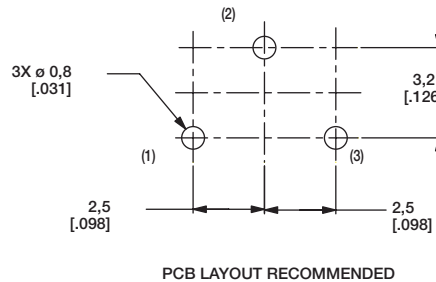
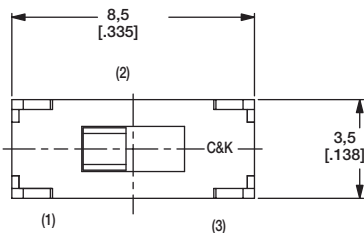

Part Number  
JS102011CQN  
SPDT

Shown in position a

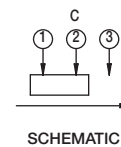
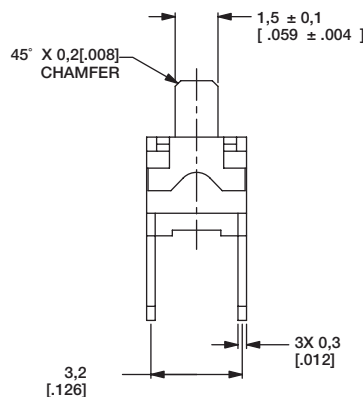
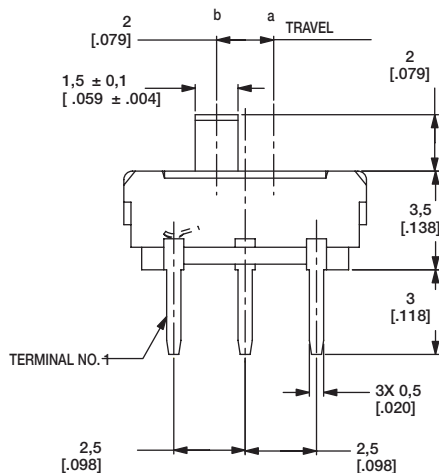

Shown in position b

# JS Series Sub-Miniature Slide Switches

## SURFACE MOUNT

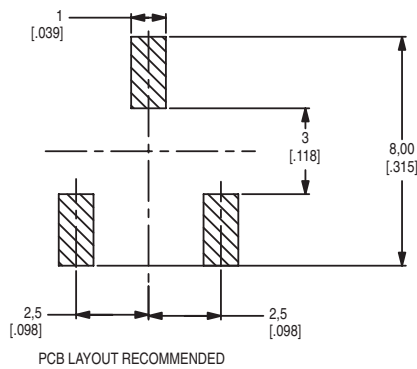

Part Number  
JS102011SCQN  
**SPDT**

Shown in position a

Available in tape & reel  
only, see page I-59



Slide

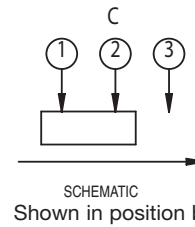
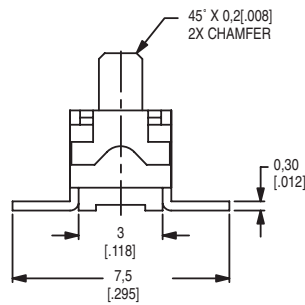

## SURFACE MOUNT

**NEW**

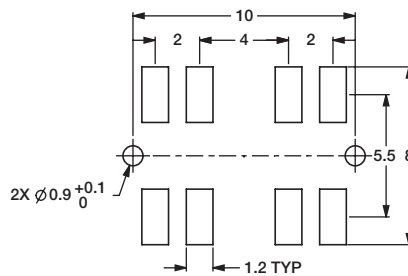
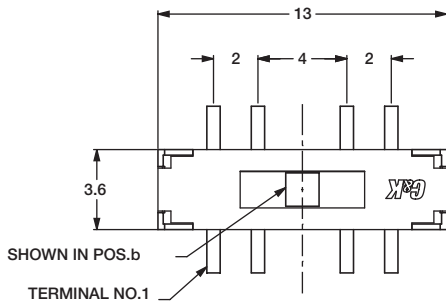

PC MOUNT - TOLERANCE ±.05

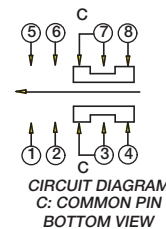

Part Number  
JS207011SCQNR  
**DP3T**

Shown in position b

Available in tape & reel  
only, see page I-58

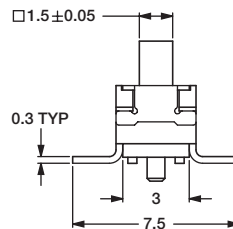
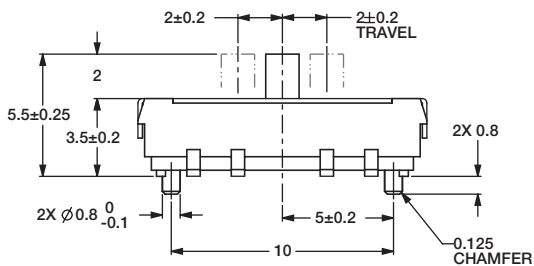

SWITCH FUNCTION		
POS.c	POS.b	POS.a
(MOM)	ON	ON
CONNECTED TERMINALS		
1-3,5-7	2-3,6-7	3-4,7-8



Third Angle  
Projection

Dimensions are shown: Inches (mm)  
Specifications and dimensions subject to change

# JS Series Sub-Miniature Slide Switches

## PC THRU-HOLE

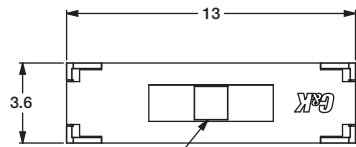

SHOWN IN POS.b

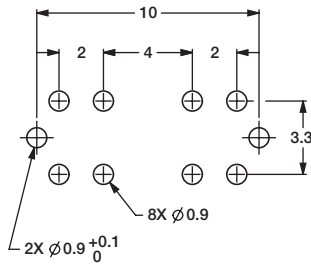

PC MOUNT - TOLERANCE ±.05

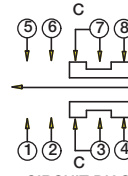

CIRCUIT DIAGRAM  
C: COMMON PIN  
BOTTOM VIEW

SWITCH FUNCTION		
POS.c	POS.b	POS.a
(MOM)	ON	ON
CONNECTED TERMINALS		
1-3,5-7	2-3,6-7	3-4,7-8

**NEW**

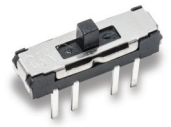

Part Number  
JS207011CQNR  
**DP3T**

Shown in position b

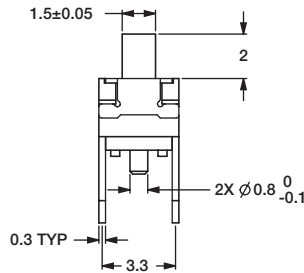
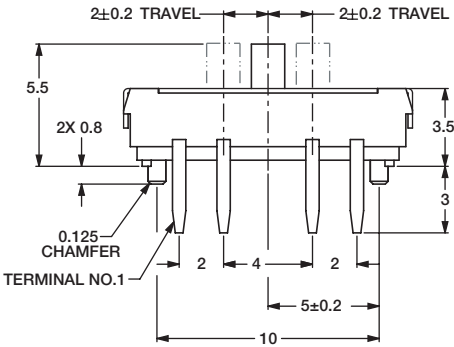

Slide

## RIGHT ANGLE SURFACE MOUNT

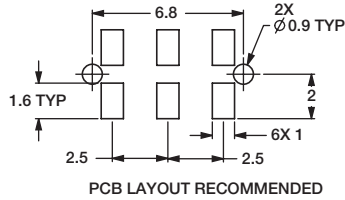
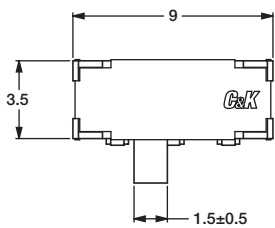

PCB LAYOUT RECOMMENDED

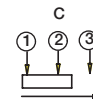

CIRCUIT DIAGRAM  
C: COMMON PIN  
BOTTOM VIEW

**NEW**



Part Number  
JS102011JAQN  
**SPDT**

Shown in position

Available in tape & reel  
only, see page I-59

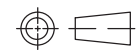
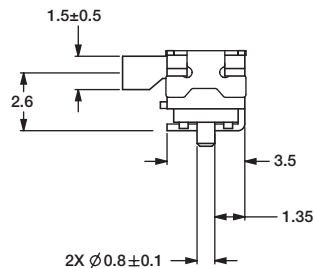
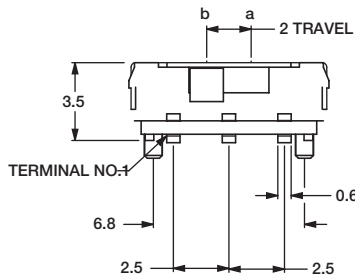

Third Angle  
Projection

Dimensions are shown: mm  
Specifications and dimensions subject to change

# JS Series Sub-Miniature Slide Switches

## VERTICAL MOUNT SMT - J BEND

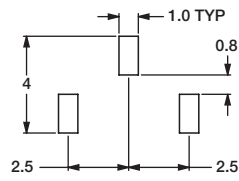
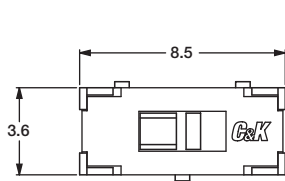

PCB LAYOUT RECOMMENDED

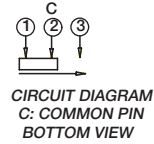

**NEW**

Part Number  
JS102011JCQN  
**SPDT**

Available in tape & reel  
only, see page I-59

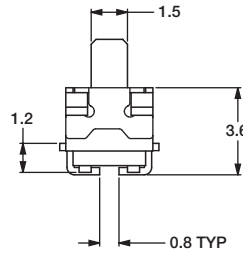
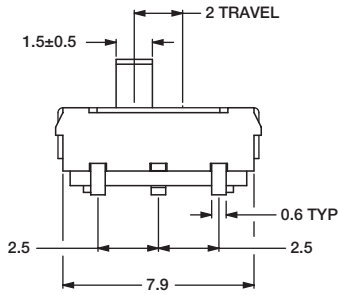

## RIGHT ANGLE SURFACE MOUNT

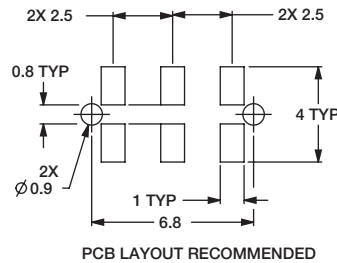
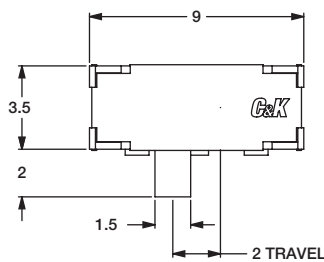

PCB LAYOUT RECOMMENDED

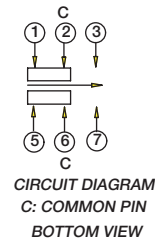

**NEW**

Part Number  
JS202011JAQN  
**DPDT**

Shown in position

Available in tape & reel  
only, see page I-61

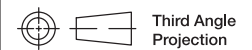
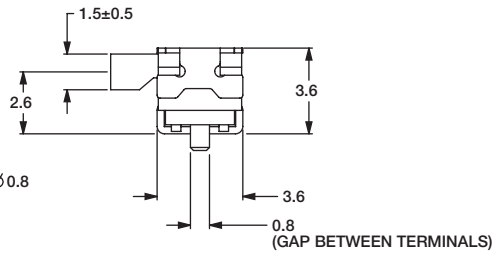
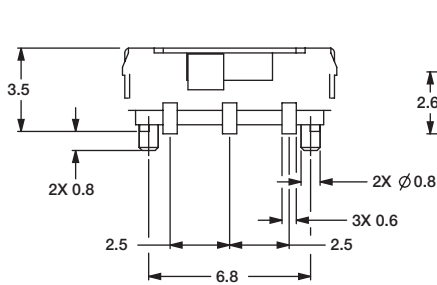

Dimensions are shown: mm  
Specifications and dimensions subject to change

# JS Series Sub-Miniature Slide Switches

## VERTICAL MOUNT SMT - J BEND

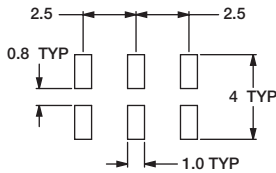
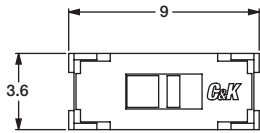

PCB LAYOUT RECOMMENDED

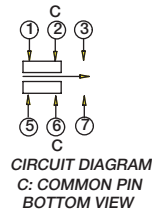

Part Number  
JS202011JCQN  
**DPDT**

Shown in position

Available in tape & reel  
only, see page I-61

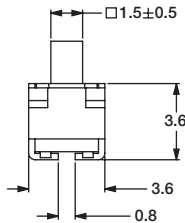
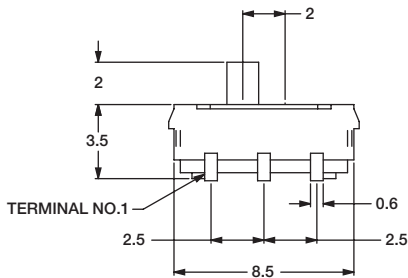

## RIGHT ANGLE MOUNT SMT - J BEND

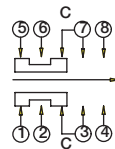
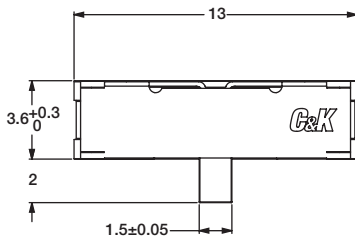

Part Number  
JS203011JAQN  
**DP3T**

Shown in position

Available in tape & reel  
only, see page I-60

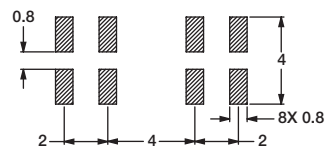
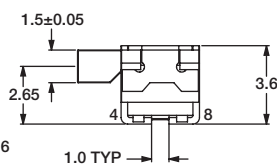
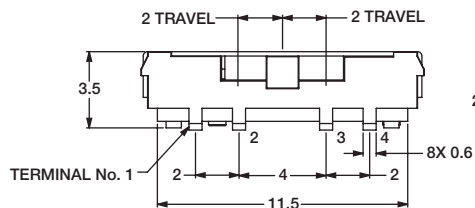

PCB LAYOUT RECOMMENDED

Slide



# JS Series Sub-Miniature Slide Switches

## VERTICAL MOUNT SMT - J BEND

**NEW**



Part Number  
JS203011JCQN  
**DP3T**

Available in tape & reel  
only, see page I-60



Slide

## SURFACE MOUNT - J BEND

**NEW**



Part Number  
JS207011JCQNR  
**SP3T**

Available in tape & reel  
only, see page I-58

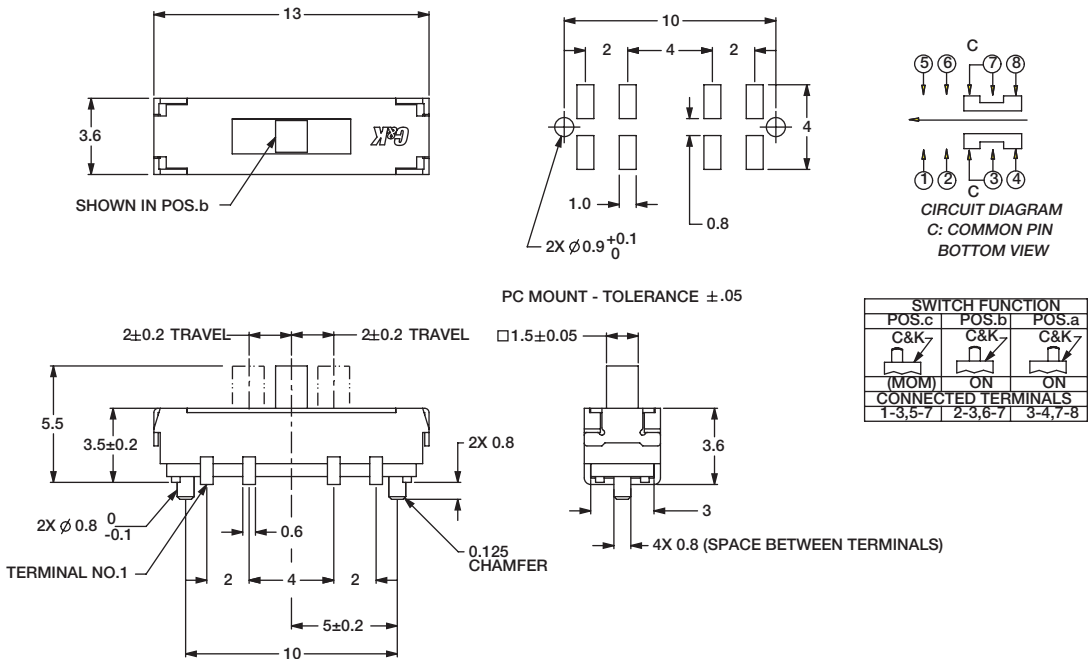

# JS Series Sub-Miniature Slide Switches

TAPE AND REEL FOR PART NUMBER JS207011SCQNR, JS207011JCQNR

Quantity per reel 800

PACKING DETAIL 800 PCS

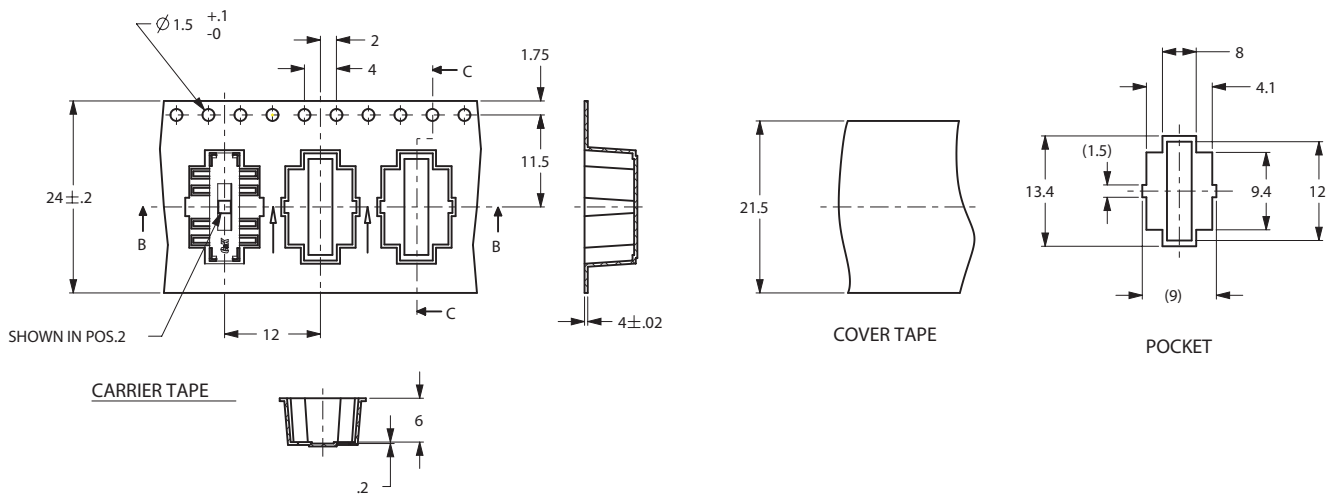
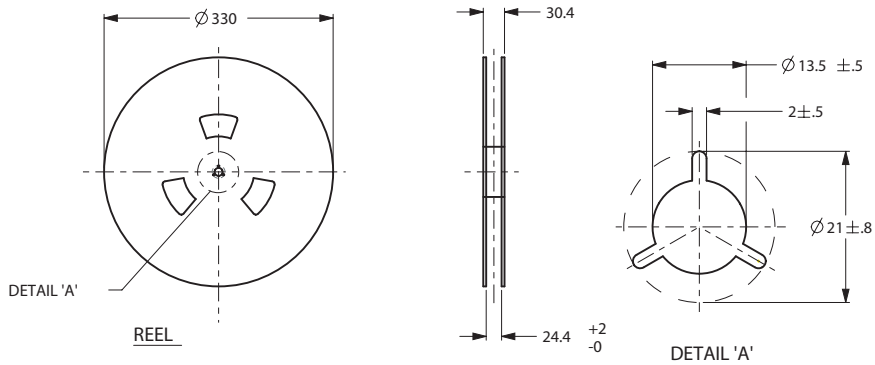

TAPE AND REEL FOR PART NUMBER JS202011SCQN

Quantity per reel 1000

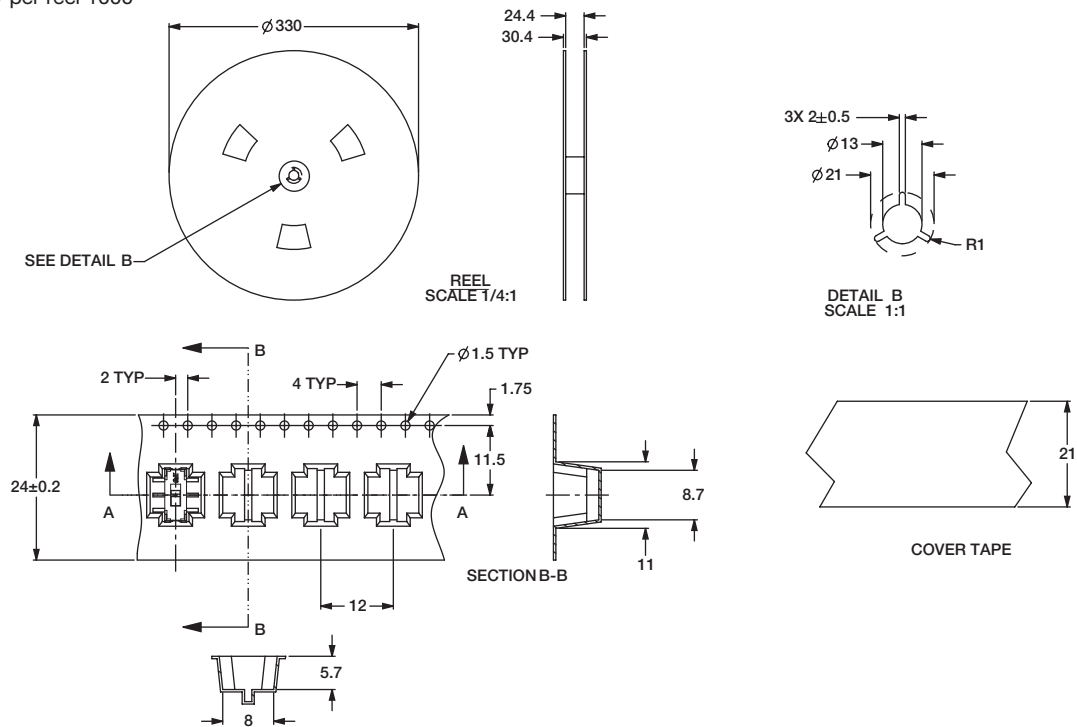

Slide

# JS Series Sub-Miniature Slide Switches

## TAPE AND REEL FOR PART NUMBER JS102011SCQN, JS102011JCQN

Quantity per reel 1000

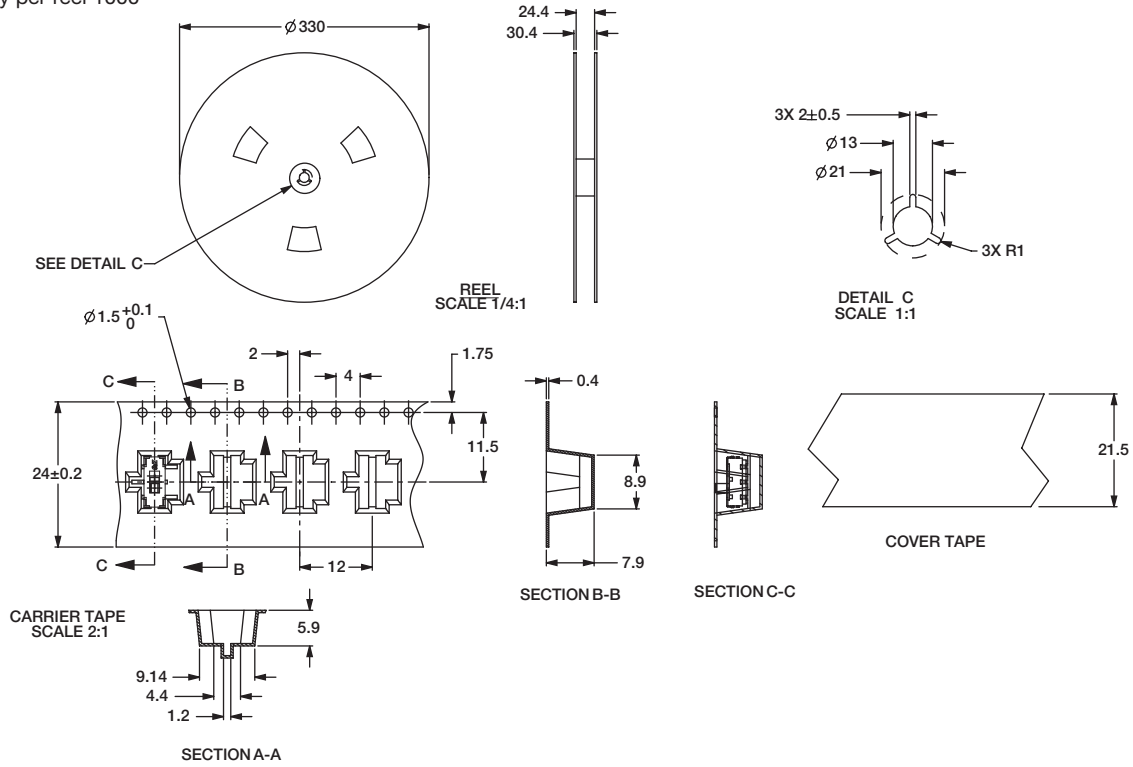

## TAPE AND REEL FOR PART NUMBER JS102011SAQN, JS102011JAQN

Quantity per reel 1000

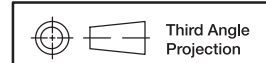

Dimensions are shown: mm  
Specifications and dimensions subject to change

# JS Series Sub-Miniature Slide Switches

**TAPE AND REEL FOR PART NUMBER JS203011SCQN, JS203011JCQN**  
Quantity per reel 900



**TAPE AND REEL FOR PART NUMBER JS203011JAQN**

Quantity per reel 1000



# JS Series Sub-Miniature Slide Switches

## TAPE AND REEL FOR PART NUMBER JS202011JCQN

Quantity per reel 1300



## TAPE AND REEL FOR PART NUMBER JS202011JAQN

Quantity per reel 1000

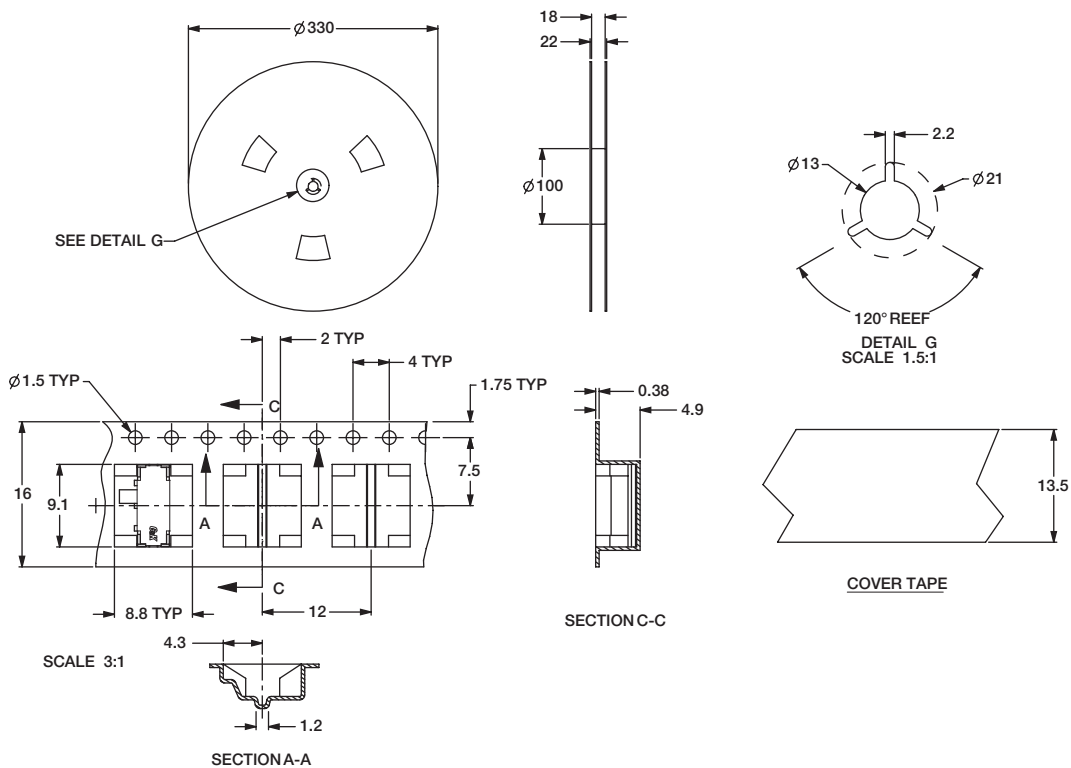

# JS Series Sub-Miniature Slide Switches

## RIGHT ANGLE SURFACE MOUNT

LOW PROFILE .028±.004 (0.7±0.1) HIGH



Part Number  
JS102000SAQN  
SPDT

## Specifications

CONTACT RATING: 5 VDC @ 1mA

ELECTRICAL LIFE: 15,000 cycles.

CONTACT RESISTANCE: <100 m ohms (initial) <200 m ohms (after processing).

INSULATION RESISTANCE: 100 m ohms @500 VDC.

DIELECTRIC STRENGTH: 250 VAC.

OPERATING TEMPERATURE: -40°C to +85°C



## TAPE AND REEL FOR PART NUMBER JS102000SAQN

Quantity per reel 4000



Компания «Life Electronics» занимается поставками электронных компонентов импортного и отечественного производства от производителей и со складов крупных дистрибьюторов Европы, Америки и Азии.

С конца 2013 года компания активно расширяет линейку поставок компонентов по направлению коаксиальный кабель, кварцевые генераторы и конденсаторы (керамические, пленочные, электролитические), за счёт заключения дистрибьюторских договоров

Мы предлагаем:

- Конкурентоспособные цены и скидки постоянным клиентам.
- Специальные условия для постоянных клиентов.
- Подбор аналогов.
- Поставку компонентов в любых объемах, удовлетворяющих вашим потребностям.
- Приемлемые сроки поставки, возможна ускоренная поставка.
- Доставку товара в любую точку России и стран СНГ.
- Комплексную поставку.
- Работу по проектам и поставку образцов.
- Формирование склада под заказчика.
- Сертификаты соответствия на поставляемую продукцию (по желанию клиента).
- Тестирование поставляемой продукции.
- Поставку компонентов, требующих военную и космическую приемку.
- Входной контроль качества.
- Наличие сертификата ISO.

В составе нашей компании организован Конструкторский отдел, призванный помогать разработчикам, и инженерам.

Конструкторский отдел помогает осуществить:

- Регистрацию проекта у производителя компонентов.
- Техническую поддержку проекта.
- Защиту от снятия компонента с производства.
- Оценку стоимости проекта по компонентам.
- Изготовление тестовой платы монтаж и пусконаладочные работы.



Тел: +7 (812) 336 43 04 (многоканальный)

Email: [org@lifeelectronics.ru](mailto:org@lifeelectronics.ru)