

## MAX5386/MAX5388

## Dual, 256-Tap, Volatile, Low-Voltage Linear Taper Digital Potentiometers

### General Description

The MAX5386/MAX5388 dual, 256-tap, volatile, low-voltage linear taper digital potentiometers offer three end-to-end resistance values of 10k $\Omega$ , 50k $\Omega$ , and 100k $\Omega$ . Operating from a single +2.6V to +5.5V power supply these devices provide a low 35ppm/ $^{\circ}$ C end-to-end temperature coefficient. The devices feature an SPI interface.

The small package size, low supply voltage, low supply current, and automotive temperature range of the MAX5386/MAX5388 make the devices uniquely suitable for the portable consumer market and battery-backup industrial applications.

The MAX5386 includes two digital potentiometers in a voltage-divider configuration. The MAX5388 includes one digital potentiometer in a voltage-divider configuration and one digital potentiometer in a variable-resistor configuration. The MAX5386/MAX5388 are specified over an extended -40 $^{\circ}$ C to +125 $^{\circ}$ C temperature range and are available in 16-pin, 3mm x 3mm TQFN or 10-pin, 3mm x 5mm  $\mu$ MAX<sup>®</sup> packages, respectively.

### Applications

- Low-Voltage Battery Applications
- Portable Electronics
- Mechanical Potentiometer Replacement
- Offset and Gain Control
- Adjustable Voltage References/Linear Regulators

**Functional Diagrams appear at end of data sheet.**

### Pin Configurations

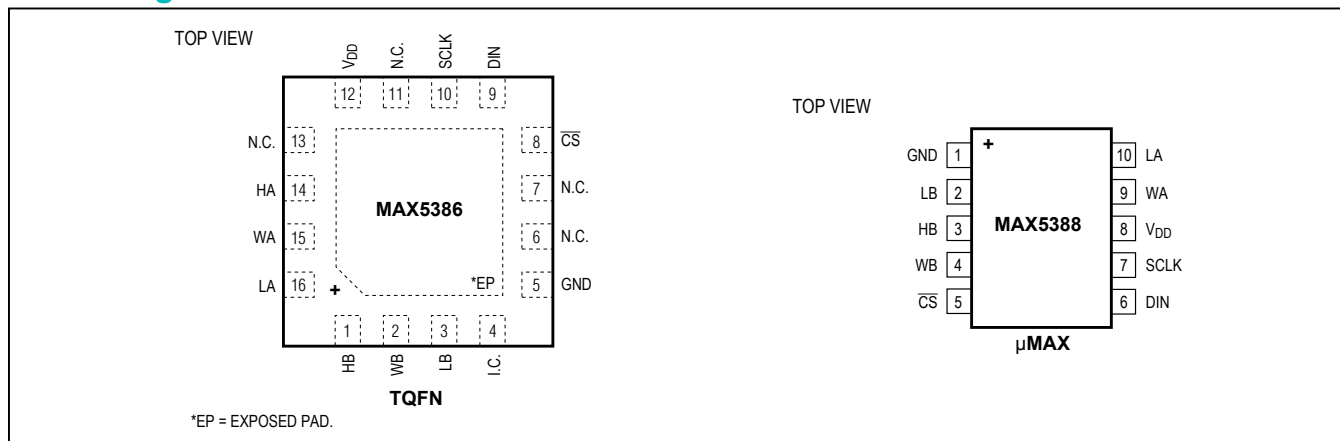

### Features

- Dual, 256-Tap, Linear Taper Positions
- Single +2.6V to +5.5V Supply Operation
- Low (< 1 $\mu$ A) Quiescent Supply Current
- 10k $\Omega$ , 50k $\Omega$ , 100k $\Omega$  End-to-End Resistance Values
- SPI-Compatible Interface
- Power-On Sets Wiper to Midscale
- -40 $^{\circ}$ C to +125 $^{\circ}$ C Operating Temperature Range

### Ordering Information

| PART         | PIN-PACKAGE  | END-TO-END RESISTANCE (k $\Omega$ ) |
|--------------|--------------|-------------------------------------|
| MAX5386LATE+ | 16 TQFN-EP*  | 10                                  |
| MAX5386MATE+ | 16 TQFN-EP*  | 50                                  |
| MAX5386NATE+ | 16 TQFN-EP*  | 100                                 |
| MAX5388LAUB+ | 10 $\mu$ MAX | 10                                  |
| MAX5388MAUB+ | 10 $\mu$ MAX | 50                                  |
| MAX5388NAUB+ | 10 $\mu$ MAX | 100                                 |

**Note:** All devices are specified over the -40 $^{\circ}$ C to +125 $^{\circ}$ C operating temperature range.

+Denotes a lead(Pb)-free/RoHS-compliant package.

\*EP = Exposed pad.

$\mu$ MAX is a registered trademark of Maxim Integrated Products, Inc.

**Absolute Maximum Ratings**

|   |  |   |                 |
|---|--|---|-----------------|
| V <sub>DD</sub> to GND.....   | -0.3V to +6V   | Continuous Power Dissipation (T <sub>A</sub> = +70°C) |                 |
| H <sub>-</sub> , W <sub>-</sub> , L <sub>-</sub> to GND.....                  | -0.3V to the lower of (V <sub>DD</sub> + 0.3V) and +6V | 16 TQFN (derate 14.7mW/°C above+70°C).....            | 1176.5mW        |
| All Other Pins to GND.....  | -0.3V to +6V   | 10 μMAX (derate 8.8mW/°C above+70°C).....             | 707.3mW         |
| Continuous Current in to H <sub>-</sub> , W <sub>-</sub> , and L <sub>-</sub> |  | Operating Temperature Range.....                      | -40°C to +125°C |
| MAX5386L/MAX5388L.....  | ±5mA   | Junction Temperature.....                             | +150°C          |
| MAX5386M/MAX5388M.....  | ±2mA   | Storage Temperature Range.....                        | -65°C to +150°C |
| MAX5386N/MAX5388N.....  | ±1mA   | Lead Temperature (soldering, 10s).....                | +300°C          |

Stresses beyond those listed under "Absolute Maximum Ratings" may cause permanent damage to the device. These are stress ratings only, and functional operation of the device at these or any other conditions beyond those indicated in the operational sections of the specifications is not implied. Exposure to absolute maximum rating conditions for extended periods may affect device reliability.

**Electrical Characteristics**

(V<sub>DD</sub> = +2.6V to +5.5V, V<sub>H-</sub> = V<sub>DD</sub>, V<sub>L-</sub> = GND, T<sub>A</sub> = T<sub>MIN</sub> to T<sub>MAX</sub>, unless otherwise noted. Typical values are at V<sub>DD</sub> = +5V, T<sub>A</sub> = +25°C. ) (Note 1)

| PARAMETER   | SYMBOL                            | CONDITIONS   | MIN               | TYP  | MAX   | UNITS  |     |
|---|-----------------------------------|--|-------------------|------|-------|--------|-----|
| Resolution  | N                                 |  | 256               |      |       | Tap    |     |
| <b>DC PERFORMANCE (VOLTAGE-DIVIDER MODE)</b>            |                                   |  |                   |      |       |        |     |
| Integral Nonlinearity                                   | INL                               | (Note 2)   | -0.5              |      | +0.5  | LSB    |     |
| Differential Nonlinearity                               | DNL                               | (Note 2)   | -0.5              |      | +0.5  | LSB    |     |
| Dual Code Matching                                      |                                   | Register A = register B                              | -0.5              |      | +0.5  | LSB    |     |
| Ratiometric Resistor Tempco                             |                                   | (ΔV <sub>W</sub> /V <sub>W</sub> )/ΔT no load        |                   | ±5   |       | ppm/°C |     |
| Full-Scale Error  |                                   | Code = FFH   | MAX5386L/MAX5388L | -3.0 | -2.5  | LSB    |     |
|   |                                   |  | MAX5386M/MAX5388M | -1.0 | -0.5  |        |     |
|   |                                   |  | MAX5386N/MAX5388N | -0.5 | -0.25 |        |     |
| Zero-Scale Error  |                                   | Code = 00H   | MAX5386L/MAX5388L |      | 2.5   | 3.0    | LSB |
|   |                                   |  | MAX5386M/MAX5388M |      | +0.5  | +1.0   |     |
|   |                                   |  | MAX5386N/MAX5388N |      | +0.25 | +0.5   |     |
| <b>DC PERFORMANCE (VARIABLE-RESISTOR MODE) (Note 3)</b> |                                   |  |                   |      |       |        |     |
| Integral Nonlinearity                                   | R-INL                             | V <sub>DD</sub> > +2.6V                              | MAX5386L/MAX5388L |      | ±1.0  | ±2.5   | LSB |
|   |                                   |  | MAX5386M/MAX5388M |      | ±0.5  | ±1.0   |     |
|   |                                   |  | MAX5386N/MAX5388N |      | ±0.25 | ±0.8   |     |
|   |                                   | V <sub>DD</sub> > +4.75V                             | MAX5386L/MAX5388L |      | ±0.4  | ±1.5   |     |
|   |                                   |  | MAX5386M/MAX5388M |      | ±0.3  | ±0.75  |     |
|   |                                   |  | MAX5386N/MAX5388N |      | ±0.25 | ±0.5   |     |
| Differential Nonlinearity                               | R-DNL                             | V <sub>DD</sub> ≥ 2.6V                               | -0.5              |      | +0.5  | LSB    |     |
| <b>DC PERFORMANCE (RESISTOR CHARACTERISTICS)</b>        |                                   |  |                   |      |       |        |     |
| Wiper Resistance (Note 4)                               | R <sub>W</sub>                    | V <sub>DD</sub> ≥ 2.6V                               |                   | 250  | 600   | Ω      |     |
|   |                                   | V <sub>DD</sub> > 4.75V                              |                   | 150  | 200   |        |     |
| Terminal Capacitance                                    | C <sub>H-</sub> , C <sub>L-</sub> | Measured to GND                                      |                   | 10   |       | pF     |     |
| Wiper Capacitance                                       | C <sub>W-</sub>                   | Measured to GND                                      |                   | 50   |       | pF     |     |
| End-to-End Resistor Tempco                              | TC <sub>R</sub>                   | No load  |                   | 35   |       | ppm/°C |     |
| End-to-End Resistor Tolerance                           | ΔR <sub>HL</sub>                  | Wiper not connected                                  | -25               |      | +25   | %      |     |
| <b>AC PERFORMANCE</b>                                   |                                   |  |                   |      |       |        |     |
| Crosstalk   |                                   | (Note 5)   |                   | -90  |       | dB     |     |
| -3dB Bandwidth  | BW                                | Code = 80H,<br>10pF load,<br>V <sub>DD</sub> = +2.6V | MAX5386L/MAX5388L |      | 600   | kHz    |     |
|   |                                   |  | MAX5386M/MAX5388M |      | 150   |        |     |
|   |                                   |  | MAX5386N/MAX5388N |      | 75    |        |     |

**Electrical Characteristics (continued)**

( $V_{DD} = +2.6V$  to  $+5.5V$ ,  $V_{H\_} = V_{DD}$ ,  $V_{L\_} = GND$ ,  $T_A = T_{MIN}$  to  $T_{MAX}$ , unless otherwise noted. Typical values are at  $V_{DD} = +5V$ ,  $T_A = +25^{\circ}C$ .) (Note 1)

| PARAMETER                              | SYMBOL    | CONDITIONS                                  | MIN | TYP   | MAX | UNITS      |
|--|-----------|---|-----|-------|-----|------------|
| Total Harmonic Distortion Plus Noise   | THD+N     | Measured at W, $V_{H\_} = 1V_{RMS}$ at 1kHz |     | 0.015 |     | %          |
| Wiper Settling Time (Note 6)           | $t_S$     | MAX5386L/MAX5388L                           |     | 300   |     | ns         |
|  |           | MAX5386M/MAX5388M                           |     | 1000  |     |            |
|  |           | MAX5386N/MAX5388N                           |     | 2000  |     |            |
| <b>POWER SUPPLIES</b>                  |           |   |     |       |     |            |
| Supply Voltage Range                   | $V_{DD}$  |   | 2.6 |       | 5.5 | V          |
| Standby Current                        |           | Digital inputs = $V_{DD}$ or GND            |     | 1     |     | $\mu A$    |
| <b>DIGITAL INPUTS</b>                  |           |   |     |       |     |            |
| Minimum Input High Voltage             | $V_{IH}$  |   | 70  |       |     | % $V_{DD}$ |
| Maximum Input Low Voltage              | $V_{IL}$  |   |     |       | 30  | % $V_{DD}$ |
| Input Leakage Current                  |           |   | -1  |       | +1  | $\mu A$    |
| Input Capacitance                      |           |   |     | 5     |     | pF         |
| <b>TIMING CHARACTERISTICS (Note 7)</b> |           |   |     |       |     |            |
| Maximum SCLK Frequency                 | $f_{MAX}$ |   |     |       | 10  | MHz        |
| SCLK Clock Period                      | $t_{CP}$  |   | 100 |       |     | ns         |
| SCLK Pulse-Width High                  | $t_{CH}$  |   | 40  |       |     | ns         |
| SCLK Pulse-Width Low                   | $t_{CL}$  |   | 40  |       |     | ns         |
| CS Fall to SCLK Rise Setup Time        | $t_{CSS}$ |   | 40  |       |     | ns         |
| SCLK Rise to CS Rise Hold Time         | $t_{CSH}$ |   | 0   |       |     | ns         |
| DIN Setup Time                         | $t_{DS}$  |   | 40  |       |     | ns         |
| DIN Hold Time                          | $t_{DH}$  |   | 0   |       |     | ns         |
| SCLK Rise to CS Fall Delay             | $t_{CS0}$ |   | 10  |       |     | ns         |
| SCLK Rise to SCLK Rise Hold Time       | $t_{CS1}$ |   | 40  |       |     | ns         |
| $\overline{CS}$ Pulse-Width High       | $t_{CSW}$ |   | 100 |       |     | ns         |

**Note 1:** All devices are 100% production tested at  $T_A = +25^{\circ}C$ . Specifications over temperature limits are guaranteed by design and characterization.

**Note 2:** DNL and INL are measured with the potentiometer configured as a voltage-divider (Figure 1) with  $H = V_{DD}$  and  $L = GND$ . The wiper terminal is unloaded and measured with an ideal voltmeter.

**Note 3:** R-DNL and R-INL are measured with the potentiometer configured as a variable resistor (Figure 1). DNL and INL are measured with the potentiometer configured as a variable resistor.  $H_{-}$  is unconnected and  $L_{-} = GND$ . For  $V_{DD} = +5V$ , the wiper terminal is driven with a source current of  $400\mu A$  for the  $10k\Omega$  configuration,  $80\mu A$  for the  $50k\Omega$  configuration, and  $40\mu A$  for the  $100k\Omega$  configuration. For  $V_{DD} = +2.6V$ , the wiper terminal is driven with a source current of  $200\mu A$  for the  $10k\Omega$  configuration,  $40\mu A$  for the  $50k\Omega$  configuration, and  $20\mu A$  for the  $100k\Omega$  configuration.

**Note 4:** The wiper resistance is the worst value measured by injecting the currents given in Note 3 in to W with  $L = GND$ .  $R_W = (V_W - V_H)/I_W$ .

**Note 5:** Drive HA with a 1kHz GND to  $V_{DD}$  amplitude tone.  $LA = LB = GND$ . No load. WB is at midscale with a  $10pF$  load. Measure WB.

**Note 6:** The wiper-settling time is the worst case 0 to 50% rise time, measured between tap 0 and tap 127.  $H = V_{DD}$ ,  $L = GND$ , and the wiper terminal is loaded with  $10pF$  capacitance to ground.

**Note 7:** Digital timing is guaranteed by design and characterization, not production tested.

Typical Operating Characteristics

( $V_{DD} = 5V$ ,  $T_A = +25^\circ C$ , unless otherwise noted.)

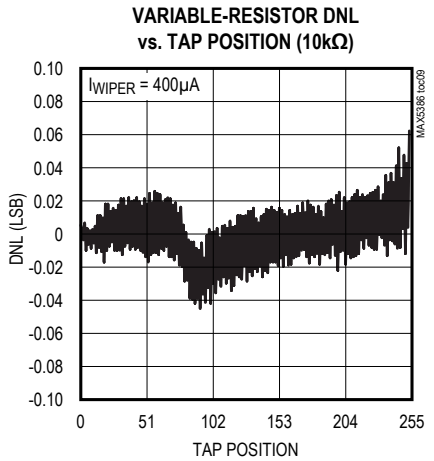
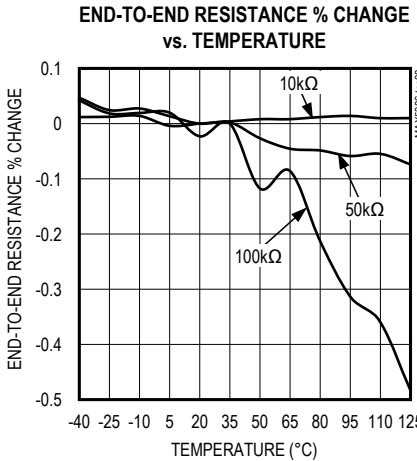
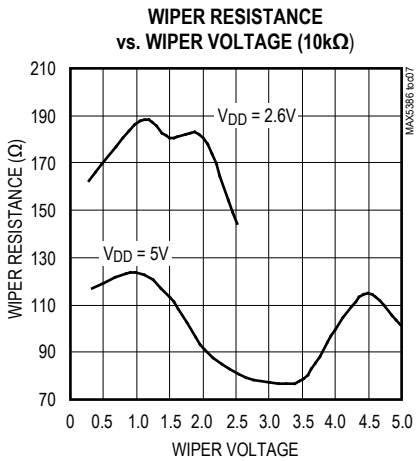
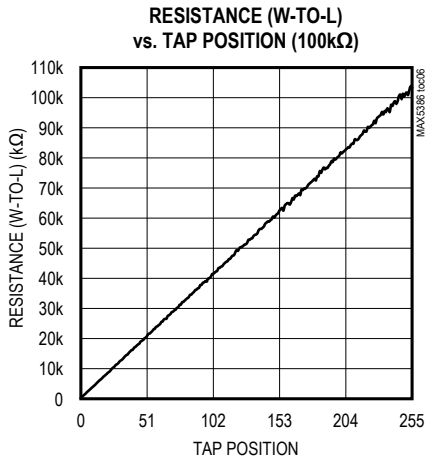
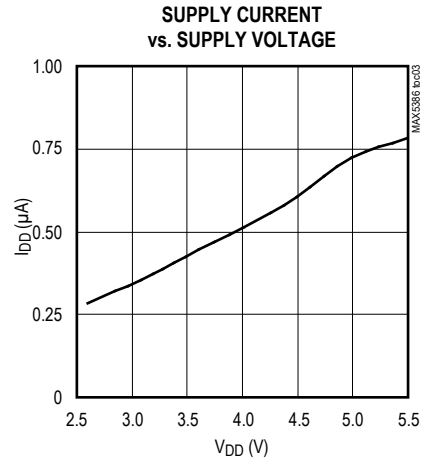

Typical Operating Characteristics (continued)

( $V_{DD} = 5V$ ,  $T_A = +25^\circ C$ , unless otherwise noted.)



Typical Operating Characteristics (continued)

( $V_{DD} = 5V$ ,  $T_A = +25^\circ C$ , unless otherwise noted.)

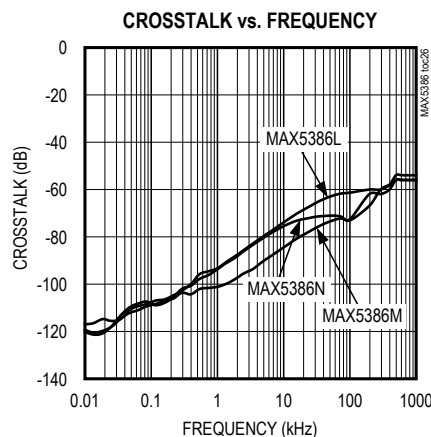
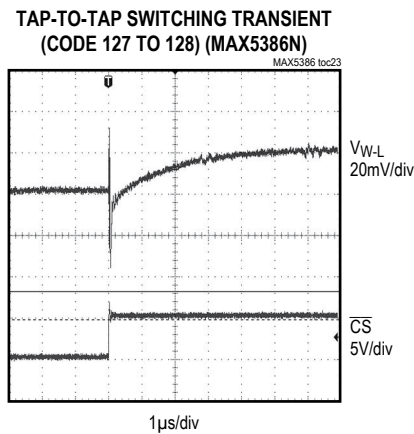
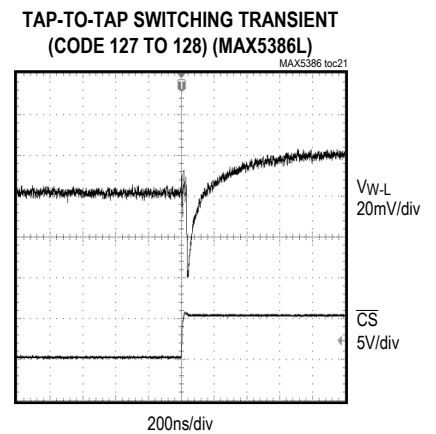

Pin Description

| PIN          |         | NAME            | FUNCTION  |
|--------------|---------|-----------------|---|
| MAX5386      | MAX5388 |                 |   |
| 1            | 3       | HB              | Resistor B High Terminal. The voltage at HB can be higher or lower than the voltage at LB. Current can flow in to or out of HB. |
| 2            | 4       | WB              | Resistor B Wiper Terminal   |
| 3            | 2       | LB              | Resistor B Low Terminal. The voltage at LB can be higher or lower than the voltage at HB. Current can flow in to or out of LB.  |
| 4            | —       | I.C.            | Internally Connected. Connect to GND.   |
| 5            | 1       | GND             | Ground. Both pins must be grounded.   |
| 6, 7, 11, 13 | —       | N.C.            | No Connection. Not internally connected.  |
| 8            | 5       | $\overline{CS}$ | Active-Low Chip-Select Input  |
| 9            | 6       | DIN             | Serial-Interface Data Input   |
| 10           | 7       | SCLK            | Serial-Interface Clock Input  |
| 12           | 8       | V <sub>DD</sub> | Power-Supply Input. Bypass V <sub>DD</sub> to GND with a 0.1μF capacitor close to the device.                                   |
| 14           | —       | HA              | Resistor A High Terminal. The voltage at HA can be higher or lower than the voltage at LA. Current can flow in to or out of HA. |
| 15           | 9       | WA              | Resistor A Wiper Terminal   |
| 16           | 10      | LA              | Resistor A Low Terminal. The voltage at LA can be higher or lower than the voltage at HA. Current can flow in to or out of LA.  |
| —            | —       | EP              | Exposed Pad (TQFN Only). Internally connected to GND. Connect to ground.  |



Figure 1. Voltage-Divider/Variable-Resistor Configurations

**Detailed Description**

The MAX5386/MAX5388 dual, 256-tap, volatile low-voltage linear taper digital potentiometers offer three end-to-end resistance values of 10kΩ, 50kΩ, and 100kΩ. Each potentiometer consists of 255 fixed resistors in series between terminals H and L. The potentiometer wiper, W, is programmable to access anyone of the 256 tap points on the resistor string.

The potentiometers in each device are programmable independently of each other. The MAX5386/MAX5388 have an SPI interface.

**SPI Digital Interface**

The MAX5386/MAX5388 include an SPI interface, which provides a 3-wire write-only serial data interface to control the wiper tap position through inputs chip select ( $\overline{CS}$ ), data in (DIN), and data clock (SCLK). Drive  $\overline{CS}$  low to load data from DIN synchronously into the serial shift register on the rising edge of each SCLK pulse. The MAX5386/MAX5388 load the last 9 bits of clocked data once  $\overline{CS}$  transitions high. See Figures 2 and 3. After all the data bits are shifted in, data are latched into the appropriate potentiometer control register when  $\overline{CS}$  goes from low to high. Data written to a memory register immediately updates the wiper position. Keep  $\overline{CS}$  low during the entire data stream to prevent the data from being terminated.

The first bit A0 (address bit) addresses one of the two potentiometers; writing a zero in A0 addresses control register A and writing a one in A0 addresses control register B. See Table 1. The power-on reset (POR) circuitry sets the wiper to midscale (D[7:0] 1000 0000).

The 8 data bits (D7–D0) indicate the position of the wiper. For D[7:0] = 0000 0000, the wiper moves to the position closest to L. For D[7:0] = 1111 1111, the wiper moves closest to H. D[7:0] is 1000 0000 following poweron for both registers A and B.

**Register A:** The data byte writes to register A, and the wiper of potentiometer A moves to the appropriate position at the rising edge of  $\overline{CS}$ . D[7:0] indicates the position of the wiper. D[7:0] = 0000 0000 moves the wiper to the position closest to L. D[7:0] = 1111 1111 moves the wiper to the position closest to H. D[7:0] is 1000 0000 following power-on.

**Register B:** The data byte writes to register B, and the wiper of potentiometer B moves to the appropriate position at the rising edge of  $\overline{CS}$ . D[7:0] indicates the position of the wiper. D[7:0] = 0000 0000 moves the wiper to the position closest to L. D[7:0] = 1111 1111 moves the wiper to the position closest to H. D[7:0] is 1000 0000 following power-on.

**Table 1. SPI Register Map**

| Bit Number             | 1  | 2  | 3  | 4  | 5  | 6  | 7  | 8  | 9  |
|------------------------|----|----|----|----|----|----|----|----|----|
| Bit Name               | A0 | D7 | D6 | D5 | D4 | D3 | D2 | D1 | D0 |
| Write Wiper Register A | 0  | D7 | D6 | D5 | D4 | D3 | D2 | D1 | D0 |
| Write Wiper Register B | 1  | D7 | D6 | D5 | D4 | D3 | D2 | D1 | D0 |





Figure 2. SPI Digital Interface Format



Figure 3. SPI Timing Diagram

**Applications Information**

**Variable-Gain Amplifier**

Figure 4 shows a potentiometer adjusting the gain of a noninverting amplifier. Figure 5 shows a potentiometer adjusting the gain of an inverting amplifier.



Figure 4. Variable-Gain Noninverting Amplifier

**Adjustable Dual Linear Regulator**

Figure 6 shows an adjustable dual linear regulator using a dual potentiometer as two variable resistors.

**Adjustable Voltage Reference**

Figure 7 shows an adjustable voltage reference circuit using a potentiometer as a voltage-divider.

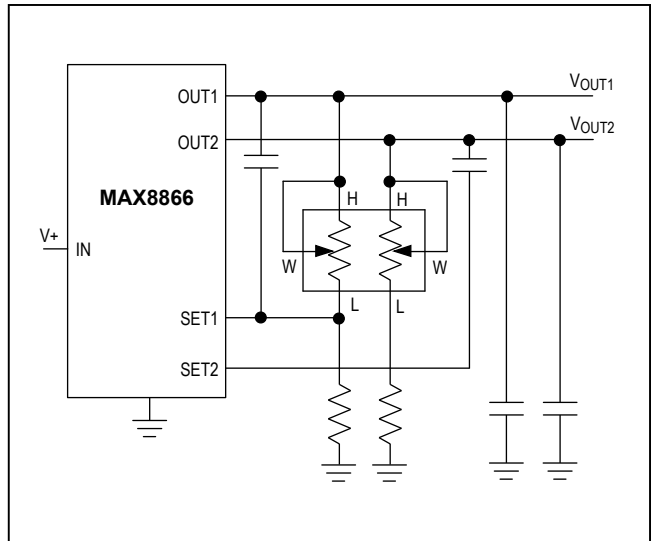

Figure 6. Adjustable Dual Linear Regulator



Figure 5. Variable-Gain Inverting Amplifier



Figure 7. Adjustable Voltage Reference

**Variable Gain Current to Voltage Converter**

Figure 8 shows a variable gain current-to-voltage converter using a potentiometer as a variable resistor.

**LCD Bias Control**

Figure 9 shows a positive LCD bias control circuit using a potentiometer as a voltage-divider.



Figure 8. Variable Gain I-to-V Converter

**Programmable Filter**

Figure 10 shows a programmable filter using a dual potentiometer.

**Offset Voltage Adjustment Circuit**

Figure 11 shows an offset voltage adjustment circuit using a dual potentiometer.



Figure 10. Programmable Filter



Figure 9. Positive LCD Bias Control Using a Voltage-Divider



Figure 11. Offset Voltage Adjustment Circuit

Functional Diagrams



Chip Information

PROCESS: BiCMOS

Package Information

For the latest package outline information and land patterns (footprints), go to [www.maximintegrated.com/packages](http://www.maximintegrated.com/packages). Note that a "+", "#", or "-" in the package code indicates RoHS status only. Package drawings may show a different suffix character, but the drawing pertains to the package regardless of RoHS status.

| PACKAGE TYPE | PACKAGE CODE | DOCUMENT NO.            | LAND PATTERN NO.        |
|--------------|--------------|-------------------------|-------------------------|
| 10 μMAX      | U10+2        | <a href="#">21-0061</a> | <a href="#">90-0330</a> |
| 16 TQFN-EP   | T1633+5      | <a href="#">21-0136</a> | <a href="#">90-0332</a> |

## Revision History

| REVISION NUMBER | REVISION DATE | DESCRIPTION   | PAGES CHANGED |
|-----------------|---------------|---|---------------|
| 0               | 4/09          | Initial release   | —             |
| 1               | 11/09         | Released MAX5386LATE+ and MAX5386NATE+ in <i>Ordering Information</i> ; corrected specifications for Full-Scale Error, Zero-Scale Error, and Integral Nonlinearity in <i>Electrical Characteristics</i> ; added I.C. row to <i>Pin Description</i> ; corrected Figure 1 | 1, 2, 7       |
| 2               | 1/10          | Released the MAX5388LAUB+, MAX5388MAUB+, MAX5388NAUB+ + in <i>Ordering Information</i> .  | 1             |
| 3               | 9/14          | Removed automotive reference from data sheet  | 1             |

For pricing, delivery, and ordering information, please contact Maxim Direct at 1-888-629-4642, or visit Maxim Integrated's website at [www.maximintegrated.com](http://www.maximintegrated.com).

Maxim Integrated cannot assume responsibility for use of any circuitry other than circuitry entirely embodied in a Maxim Integrated product. No circuit patent licenses are implied. Maxim Integrated reserves the right to change the circuitry and specifications without notice at any time. The parametric values (min and max limits) shown in the *Electrical Characteristics* table are guaranteed. Other parametric values quoted in this data sheet are provided for guidance.

Компания «Life Electronics» занимается поставками электронных компонентов импортного и отечественного производства от производителей и со складов крупных дистрибьюторов Европы, Америки и Азии.

С конца 2013 года компания активно расширяет линейку поставок компонентов по направлению коаксиальный кабель, кварцевые генераторы и конденсаторы (керамические, пленочные, электролитические), за счёт заключения дистрибьюторских договоров

Мы предлагаем:

- Конкурентоспособные цены и скидки постоянным клиентам.
- Специальные условия для постоянных клиентов.
- Подбор аналогов.
- Поставку компонентов в любых объемах, удовлетворяющих вашим потребностям.
- Приемлемые сроки поставки, возможна ускоренная поставка.
- Доставку товара в любую точку России и стран СНГ.
- Комплексную поставку.
- Работу по проектам и поставку образцов.
- Формирование склада под заказчика.
- Сертификаты соответствия на поставляемую продукцию (по желанию клиента).
- Тестирование поставляемой продукции.
- Поставку компонентов, требующих военную и космическую приемку.
- Входной контроль качества.
- Наличие сертификата ISO.

В составе нашей компании организован Конструкторский отдел, призванный помогать разработчикам, и инженерам.

Конструкторский отдел помогает осуществить:

- Регистрацию проекта у производителя компонентов.
- Техническую поддержку проекта.
- Защиту от снятия компонента с производства.
- Оценку стоимости проекта по компонентам.
- Изготовление тестовой платы монтаж и пусконаладочные работы.



Тел: +7 (812) 336 43 04 (многоканальный)  
Email: [org@lifeelectronics.ru](mailto:org@lifeelectronics.ru)