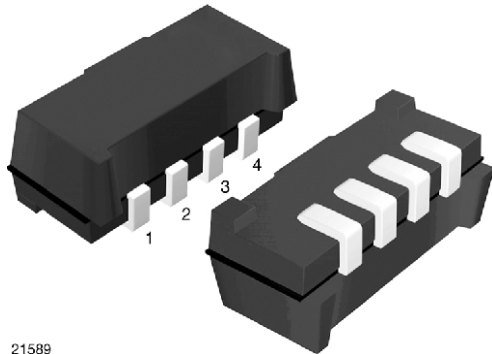


## IR Receiver Modules for Remote Control Systems



21589

### DESIGN SUPPORT TOOLS

[click logo to get started](#)



### MECHANICAL DATA

#### Pinning:

1, 4 = GND, 2 =  $V_S$ , 3 = OUT

#### ORDERING CODE EXAMPLE:

#### Taping:

TSOP77...WTT - top view taped

TSOP77...WTR - side view taped

### FEATURES

- Improved immunity against HF and RF noise
- Continuous data transmission possible
- Low supply current
- Photo detector and preamplifier in one package
- Internal filter for PCM frequency
- Supply voltage: 2.5 V to 5.5 V
- Improved immunity against ambient light
- Capable of side or top view
- Insensitive to supply voltage ripple and noise
- Low profile 2.35 mm
- Material categorization: for definitions of compliance please see [www.vishay.com/doc?99912](http://www.vishay.com/doc?99912)



### DESCRIPTION

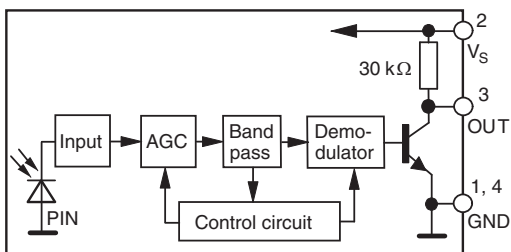
The TSOP773..W, TSOP775..W series are miniaturized receiver module for infrared remote control systems. One PIN diode per lens and a preamplifier are assembled on a leadframe, the epoxy lens cap contains an IR filter.

The TSOP773..W series devices are optimized to suppress almost all spurious pulses from Wi-Fi and CFL sources. They may suppress some data signals if continuously transmitted.

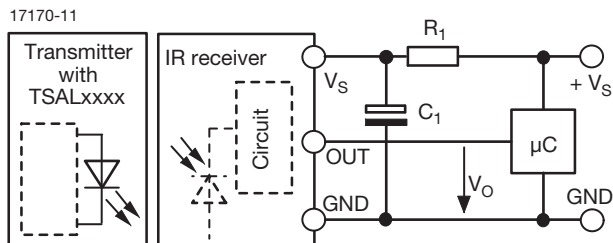
New designs should prefer the TSOP773..W series containing the newer AGC3. The TSOP775..W series are useful to suppress even extreme levels of optical noise, but may also suppress some data signals. Please check compatibility with your codes.

These components have not been qualified according to automotive specifications.

PARTS TABLE			
AGC		NOISY ENVIRONMENTS AND SHORT BURSTS (AGC3)	VERY NOISY ENVIRONMENTS AND SHORT BURSTS (AGC5)
Carrier frequency	30 kHz	TSOP77330W	TSOP77530W
	33 kHz	TSOP77333W	TSOP77533W
	36 kHz	TSOP77336W <sup>(1)</sup>	TSOP77536W
	38 kHz	TSOP77338W <sup>(2)(3)(4)(5)</sup>	TSOP77538W
	40 kHz	TSOP77340W	TSOP77540W
	56 kHz	TSOP77356W	TSOP77556W
Package		Heimdall no lens	
Pinning		1, 4 = GND, 2 = $V_S$ , 3 = OUT	
Dimensions (mm)		6.8 W x 3.0 H x 2.35 D	
Mounting		SMD	
Application		Remote control	
Best choice for		<sup>(1)</sup> MCIR <sup>(2)</sup> Mitsubishi <sup>(3)</sup> RECS-80 Code <sup>(4)</sup> r-map <sup>(5)</sup> XMP-1, XMP-2	

**BLOCK DIAGRAM**


20445-1

**APPLICATION CIRCUIT**

 $R_1$  and  $C_1$  recommended to reduce supply ripple for  $V_S < 2.8\text{ V}$ 
**ABSOLUTE MAXIMUM RATINGS**

PARAMETER	TEST CONDITION	SYMBOL	VALUE	UNIT
Supply voltage		$V_S$	-0.3 to +6	V
Supply current		$I_S$	5	mA
Output voltage		$V_O$	-0.3 to 5.5	V
Voltage at output to supply		$V_S - V_O$	-0.3 to $(V_S + 0.3)$	V
Output current		$I_O$	5	mA
Junction temperature		$T_j$	100	°C
Storage temperature range		$T_{stg}$	-25 to +85	°C
Operating temperature range		$T_{amb}$	-25 to +85	°C
Power consumption	$T_{amb} \leq 85\text{ °C}$	$P_{tot}$	10	mW
Soldering temperature	$t \leq 10\text{ s}$ , 1 mm from case	$T_{sd}$	260	°C

**Note**

- Stresses beyond those listed under “Absolute Maximum Ratings” may cause permanent damage to the device. This is a stress rating only and functional operation of the device at these or any other conditions beyond those indicated in the operational sections of this specification is not implied. Exposure to absolute maximum rating conditions for extended periods may affect the device reliability

**ELECTRICAL AND OPTICAL CHARACTERISTICS ( $T_{amb} = 25\text{ °C}$ , unless otherwise specified)**

PARAMETER	TEST CONDITION	SYMBOL	MIN.	TYP.	MAX.	UNIT
Supply voltage		$V_S$	2.5	-	5.5	V
Supply current	$V_S = 5\text{ V}$ , $E_v = 0$	$I_{SD}$	0.55	0.7	0.9	mA
	$E_v = 40\text{ klx}$ , sunlight	$I_{SH}$	-	0.8	-	mA
Transmission distance	$E_v = 0$ , IR diode TSAL6200, $I_F = 250\text{ mA}$ , test signal see Fig. 1	$d$	-	40	-	m
Output voltage low	$I_{OSL} = 0.5\text{ mA}$ , $E_e = 0.7\text{ mW/m}^2$ , test signal see Fig. 1	$V_{OSL}$	-	-	100	mV
Minimum irradiance	Pulse width tolerance: $t_{pi} - 5/f_0 < t_{po} < t_{pi} + 6/f_0$ , test signal see Fig. 1	$E_e\text{ min.}$	-	0.4	0.8	$\text{mW/m}^2$
Maximum irradiance	$t_{pi} - 5/f_0 < t_{po} < t_{pi} + 6/f_0$ , test signal see Fig. 1	$E_e\text{ max.}$	50	-	-	$\text{W/m}^2$
Directivity	Angle of half transmission distance	$\phi_{1/2}$	-	$\pm 75$	-	deg

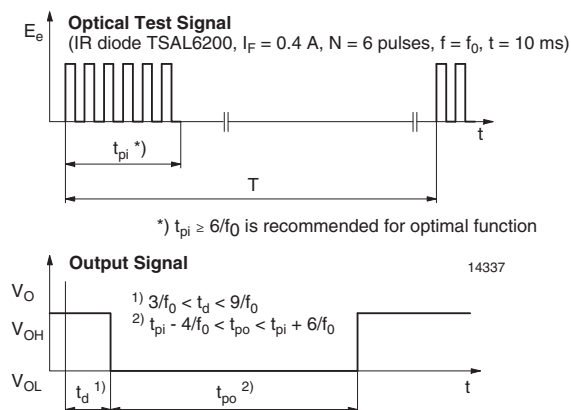
**TYPICAL CHARACTERISTICS ( $T_{amb} = 25\text{ °C}$ , unless otherwise specified)**


Fig. 1 - Output Active Low

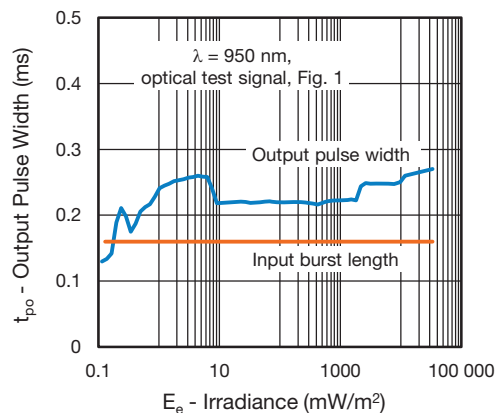


Fig. 2 - Pulse Length and Sensitivity in Dark Ambient

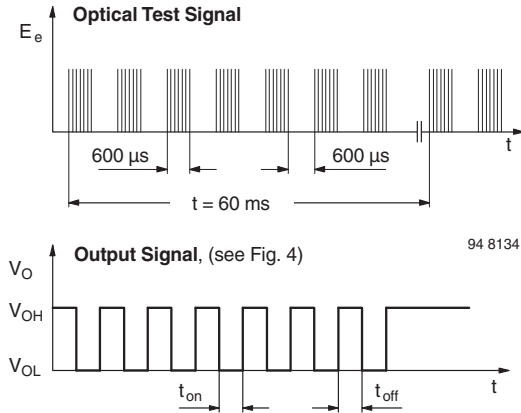


Fig. 3 - Output Function

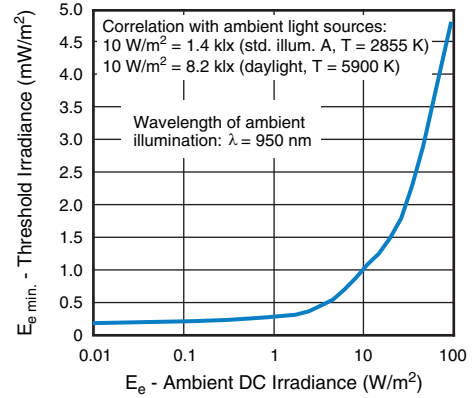


Fig. 6 - Sensitivity in Bright Ambient

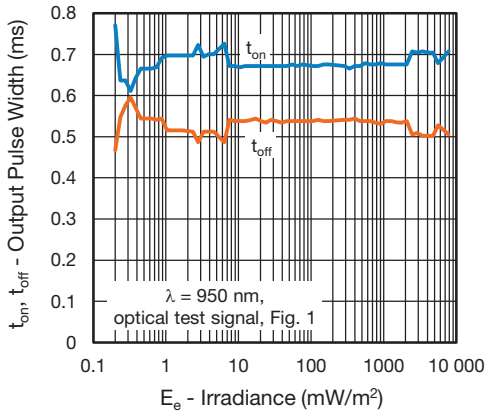


Fig. 4 - Output Pulse Diagram

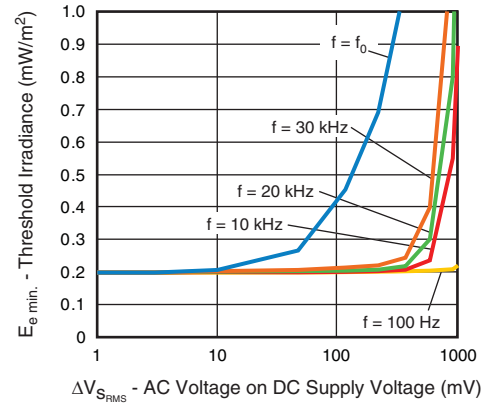


Fig. 7 - Sensitivity vs. Supply Voltage Disturbances

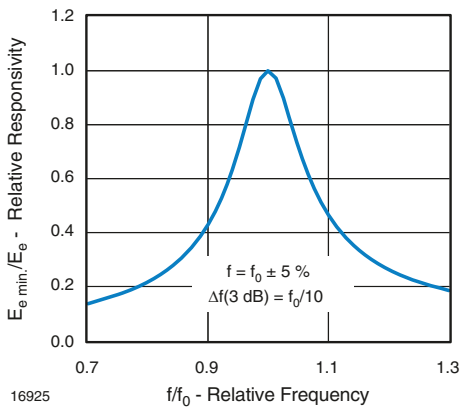


Fig. 5 - Frequency Dependence of Responsivity

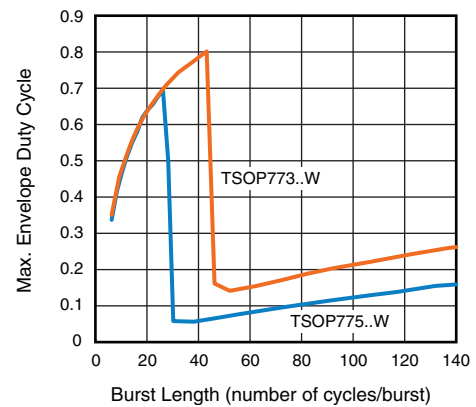


Fig. 8 - Max. Envelope Duty Cycle vs. Burst Length

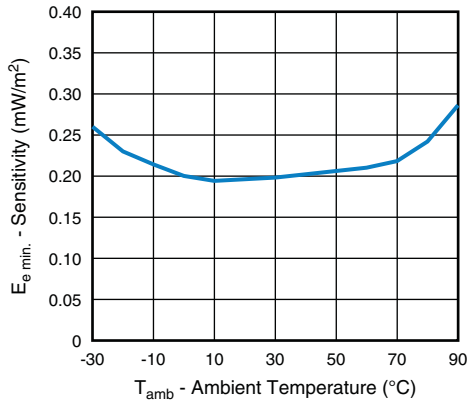


Fig. 9 - Sensitivity vs. Ambient Temperature

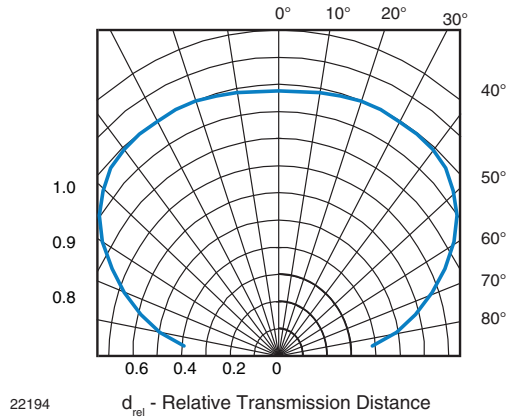


Fig. 12 - Vertical Directivity

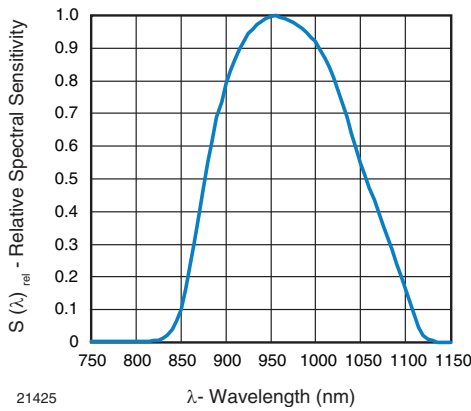


Fig. 10 - Relative Spectral Sensitivity vs. Wavelength

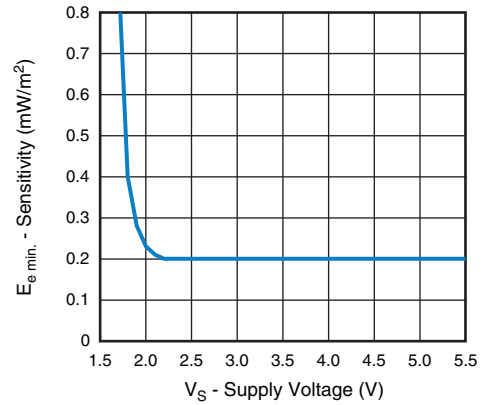


Fig. 13 - Sensitivity vs. Supply Voltage

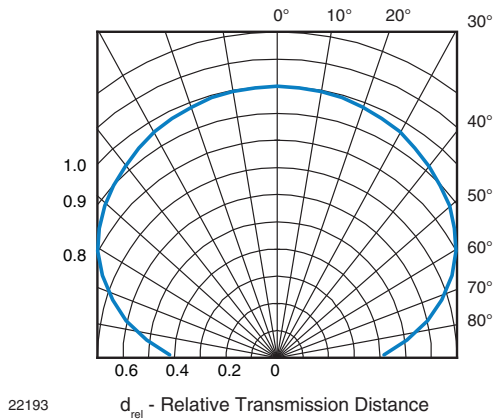


Fig. 11 - Horizontal Directivity

**SUITABLE DATA FORMAT**

These products are designed to suppress spurious output pulses due to noise or disturbance signals. Data and disturbance signals can be distinguished by the devices according to carrier frequency, burst length and envelope duty cycle. The data signal should be close to the band-pass center frequency (e.g. 38 kHz) and fulfill the conditions in the table below.

When a data signal is applied to the IR receiver in the presence of a disturbance signal, the sensitivity of the receiver is reduced to insure that no spurious pulses are present at the output. Some examples of disturbance signals which are suppressed are:

- DC light (e.g. from tungsten bulb or sunlight)
- Continuous signals at any frequency
- Modulated IR signals from common fluorescent lamps (example of noise pattern is shown in Fig. 14 or Fig. 15)
- 2.4 GHz and 5 GHz Wi-Fi



Fig. 14 - IR Disturbance from Fluorescent Lamp With Low Modulation



Fig. 15 - IR Disturbance from Fluorescent Lamp With High Modulation

	<b>TSOP773..W</b>	<b>TSOP775..W</b>
Minimum burst length	6 cycles/burst	6 cycles/burst
After each burst of length a minimum gap time is required of	6 to 35 cycles ≥ 10 cycles	6 to 24 cycles ≥ 10 cycles
For bursts greater than a minimum gap time in the data stream is needed of	35 cycles > 4 x burst length	24 cycles > 25 ms
Maximum number of continuous short bursts/second	2000	2000
MCIR code	Preferred	Yes
XMP-1, XMP-2, code	Preferred	Yes
Suppression of interference from fluorescent lamps	Mild and complex disturbance patterns are suppressed (example: signal pattern of Fig. 14 and Fig. 15)	Critical disturbance patterns are suppressed, e.g. highly dimmed LCDs

**Note**

- For data formats with long bursts (more than 10 carrier cycles) please see the datasheet for TSOP772..W, TSOP774..W



## PACKAGE DIMENSIONS in millimeters



## ASSEMBLY INSTRUCTIONS

### Reflow Soldering

- Reflow soldering must be done within 72 h while stored under a max. temperature of 30 °C, 60 % RH after opening the dry pack envelope
- Set the furnace temperatures for pre-heating and heating in accordance with the reflow temperature profile as shown in the diagram. Exercise extreme care to keep the maximum temperature below 260 °C. The temperature shown in the profile means the temperature at the device surface. Since there is a temperature difference between the component and the circuit board, it should be verified that the temperature of the device is accurately being measured
- Handling after reflow should be done only after the work surface has been cooled off

### Manual Soldering

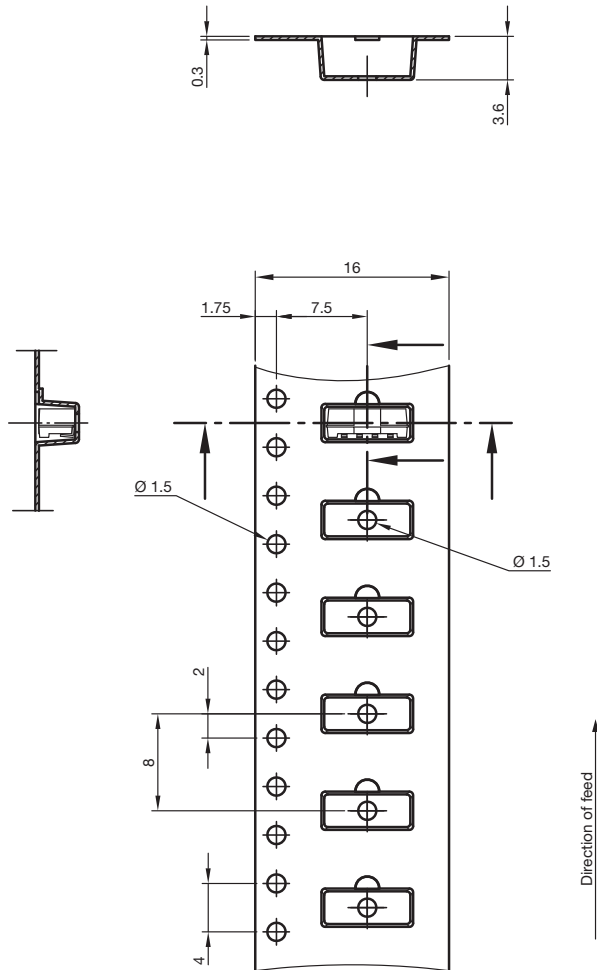
- Use a soldering iron of 25 W or less. Adjust the temperature of the soldering iron below 300 °C
- Finish soldering within 3 s
- Handle products only after the temperature has cooled off



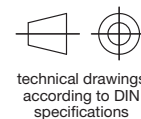
## VISHAY LEAD (Pb)-FREE REFLOW SOLDER PROFILE



## TAPING VERSION TSOP..TR DIMENSIONS in millimeters



Drawing-No.: 9.700-5342.01-4  
Issue: 2; 12.06.13





## TAPING VERSION TSOP..TT DIMENSIONS in millimeters



Drawing-No.: 9.700-5341.01-4  
Issue: 3; 06.10.15



technical drawings  
according to DIN  
specifications





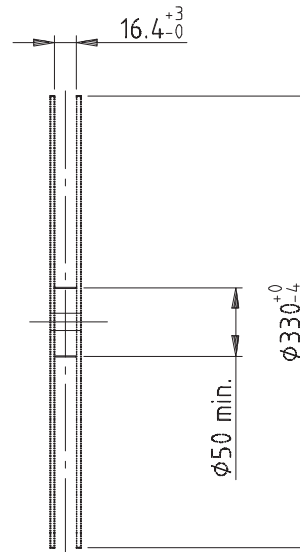
### REEL DIMENSIONS in millimeters



Drawing-No.: 9.800-5052.V2-4

Issue: 1; 07.05.02

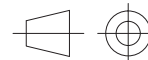
16734



Form of the leave open of the wheel is supplier specific.

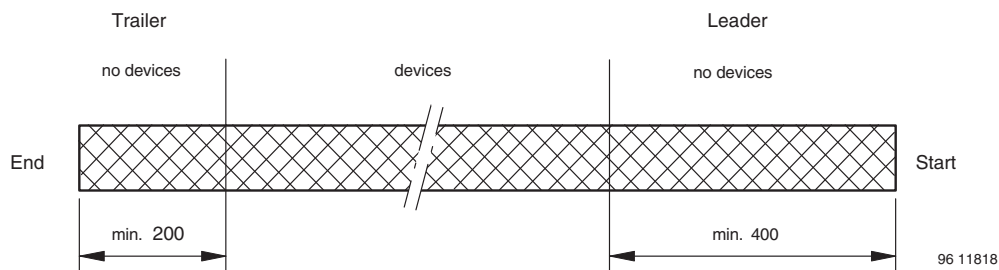
Dimension acc. to IEC EN 60 286-3

Tape width 16



technical drawings according to DIN specifications

### LEADER AND TRAILER DIMENSIONS in millimeters



96 11818

### COVER TAPE PEEL STRENGTH

According to DIN EN 60286-3

0.1 N to 1.3 N

300 ± 10 mm/min.

165° to 180° peel angle

### LABEL

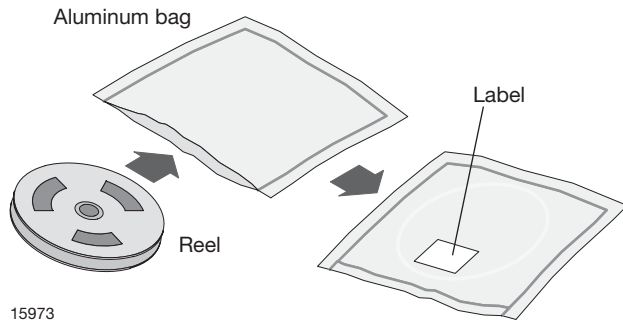
#### Standard bar code labels for finished goods

The standard bar code labels are product labels and used for identification of goods. The finished goods are packed in final packing area. The standard packing units are labeled with standard bar code labels before transported as finished goods to warehouses. The labels are on each packing unit and contain Vishay Semiconductor GmbH specific data.

<b>VISHAY SEMICONDUCTOR GmbH STANDARD BAR CODE PRODUCT LABEL (finished goods)</b>		
PLAIN WRITING	ABBREVIATION	LENGTH
Item-description	-	18
Item-number	INO	8
Selection-code	SEL	3
LOT-/serial-number	BATCH	10
Data-code	COD	3 (YWW)
Plant-code	PTC	2
Quantity	QTY	8
Accepted by	ACC	-
Packed by	PCK	-
Mixed code indicator	MIXED CODE	-
Origin	xxxxxxx+	Company logo
Long bar code top	Type	Length
Item-number	N	8
Plant-code	N	2
Sequence-number	X	3
Quantity	N	8
Total length	-	21
Short bar code bottom	Type	Length
Selection-code	X	3
Data-code	N	3
Batch-number	X	10
Filter	-	1
Total length	-	17

### DRY PACKING

The reel is packed in an anti-humidity bag to protect the devices from absorbing moisture during transportation and storage.



### FINAL PACKING

The sealed reel is packed into a cardboard box.

### RECOMMENDED METHOD OF STORAGE

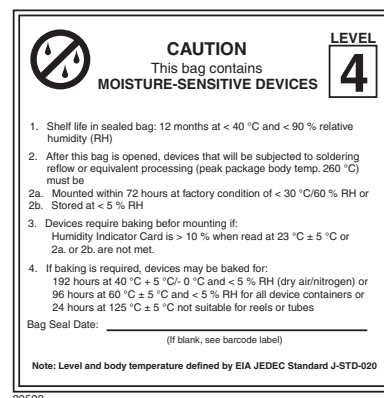
Dry box storage is recommended as soon as the aluminum bag has been opened to prevent moisture absorption. The following conditions should be observed, if dry boxes are not available:

- Storage temperature 10 °C to 30 °C
- Storage humidity ≤ 60 % RH max.

After more than 72 h under these conditions moisture content will be too high for reflow soldering.

In case of moisture absorption, the devices will recover to the former condition by drying under the following condition:  
 192 h at 40 °C + 5 °C / - 0 °C and < 5 % RH (dry air / nitrogen) or  
 96 h at 60 °C + 5 °C and < 5 % RH for all device containers or  
 24 h at 125 °C + 5 °C not suitable for reel or tubes.

An EIA JEDEC® standard J-STD-020 level 4 label is included on all dry bags.



EIA JEDEC standard J-STD-020 level 4 label is included on all dry bags



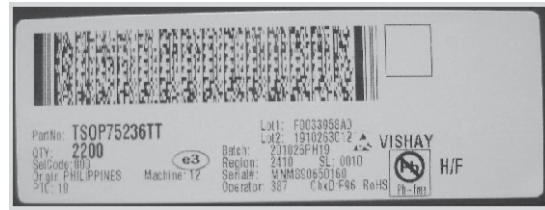
### ESD PRECAUTION

Proper storage and handling procedures should be followed to prevent ESD damage to the devices especially when they are removed from the antistatic shielding bag. Electrostatic sensitive devices warning labels are on the packaging.

### VISHAY SEMICONDUCTORS STANDARD BAR CODE LABELS

The Vishay Semiconductors standard bar code labels are printed at final packing areas. The labels are on each packing unit and contain Vishay Semiconductors specific data.

### BAR CODE PRODUCT LABEL (example)



22178



## Tape and Reel Standards for Surface-Mount IR Receiver Modules

Vishay Semiconductor surface-mount IR receivers are packaged on tape and reel. The following specification is based on IEC publication 286, which takes the industrial requirements for automatic insertion into account.

Absolute maximum ratings, mechanical dimensions, optical and electrical characteristics for taped devices are identical to the basic catalog types and can be found in the specifications for untaped devices.

### PACKAGING

The tapes of components are available on reels. Each reel is marked with labels which contain the following information:

- Vishay
- Type
- Group
- Tape code, normally part of type name
- Production code
- Quantity

### MISSING COMPONENTS

Up to 3 consecutive components may be missing if the gap is followed by at least 6 components. A maximum of 0.5 % of the components per reel quantity may be missing. At least 5 empty positions are present at the start and the end of the tape to enable tape insertion.

**Tensile strength** of the tape: > 15 N

### NUMBER OF COMPONENTS

- A. Panhead: quantity per reel:
  - TT, top view package, 1190 pcs
  - TR, side view package, 1120 pcs
- B. Heimdall: quantity per reel:
  - TT, top view package, 2200 pcs
  - TR, side view package, 2300 pcs
- C. Heimdall without lens: quantity per reel:
  - WTT, top view package, 2200 pcs
  - WTR, side view package, 2300 pcs
- D. Belobog: quantity per reel:
  - TT1, top view package, 1800 pcs
- E. Belobog with shield: quantity per reel:
  - TT1, top view package, 1500 pcs
- F. Minimold DF1P: quantity per reel:
  - DF1P, 1100 pcs
- G. TVCastSMD TR1: quantity per reel:
  - TR1, side view package, 2000 pcs

### ORDER DESIGNATION

The type designation of the device is extended by TT or TT1 for top view or TR for side view.

#### Example:

- TSOP6238TR (reel packing)
- TSOP75238TR (reel packing)
- TSOP75338WTT (reel packing)
- TSOP57438TT1 (reel packing)
- TSOP57238HTT1 (reel packing)
- TSOP39438TR1 (reel packing)



### REEL DIMENSIONS FOR PANHEAD, HEIMDALL, AND TVCASTSMD TR in millimeters



Form of the leave open of the wheel is supplier specific.

Dimension acc. to IEC EN 60 286-3

Tape width 16



technical drawings according to DIN specifications

Drawing-No.: 9.800-5052.V2-4

Issue: 1; 07.05.02

16734

#### Note

- The body structure of the reel can vary



## TAPING VERSION TSOP..TT (TOP VIEW) DIMENSIONS in millimeters

A. Panhead (TSOP36...TT, TSSP...TT, TSOP6...TT, TSOP16...TT, TSOP96...TT)



Drawing-No.: 9.700-5259.01-4

Issue: 1; 05.09.01

16584



## TAPING VERSION TSOP..TT (TOP VIEW) DIMENSIONS in millimeters

B. Heimdall (TSOP75...TT, TSOP77...TT, TSSP77...TT, TSOP15...TT, TSOP95...TT)



Drawing-No.: 9.700-5338.01-4  
Issue: 4; 12.06.13



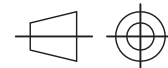
technical drawings  
according to DIN  
specifications

## TAPING VERSION TSOP..TT (TOP VIEW) DIMENSIONS in millimeters

C. Heimdall without lens (TSOP75...WTT, TSOP77...WTT, TSSP77...WTT, TSOP15...WTT, TSOP95...WTT)



Drawing-No.: 9.700-5341.01-4  
 Issue: 3; 06.10.15



technical drawings  
 according to DIN  
 specifications





### TAPING VERSION TSOP..TT1 (TOP VIEW) DIMENSIONS in millimeters

D. Belobog (TSOP37...TT1, TSOP57...TT1, TSOP17...TT1, TSOP97...TT1)

Tape and reel dimensions:



X 2:1



Drawing-No.: 9.700-5347.01-4  
Issue: 2; 07.03.18

Not indicated tolerances  $\pm 0.1$



### TAPING VERSION TSOP..TT1 (TOP VIEW) DIMENSIONS in millimeters

E. Belobog with shield (TSOP37...HTT1, TSOP57...HTT1, TSOP17...HTT1, TSOP97...HTT1)

Tape and reel dimensions:



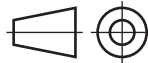
Drawing-No.: 9.700-5380.01-4  
Issue: 3; 07.03.18

Not indicated tolerances  $\pm 0.1$



### TAPING VERSION TSOP..DF1P (SIDE VIEW) DIMENSIONS in millimeters

F. Minimold DF1P (TSOP33...DF1P, TSOP53...DF1P, TSOP13...DF1P, TSOP93...DF1P)



Technical drawing according to DIN specifications

Form of the leave open of the wheel is supplier specific. Dimensions according to IEC EN 60 286-3

Tape width: 24



Reel hub 2:1

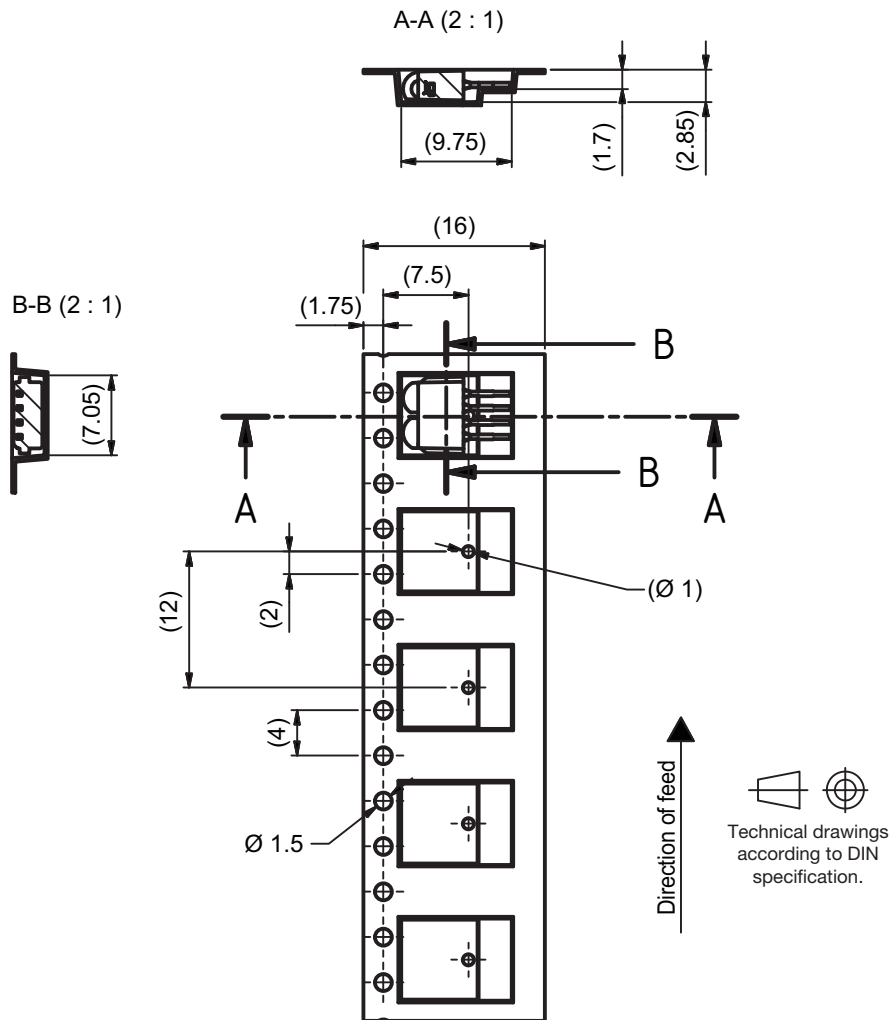
Drawing-No.: 9.800-5052.V3-4  
Issue: 1; 17.12.02



Drawing-No.: 9.700-5399.01-4  
Issue: 1; 30.06.16

## TAPING VERSION TSOP..TR (SIDE VIEW) DIMENSIONS in millimeters

G. TVCastSMD TR1 (TSOP59...TR1, TSOP39...TR1, TSOP19...TR1, TSOP99...TR1)



Drawing-No.: GO-100220.10\_Z  
Issue B: 08.02.17



## TAPING VERSION TSOP..TR (SIDE VIEW) DIMENSIONS in millimeters

A. Panhead (TSOP36...TR, TSSP6...TR, TSOP6...TR, TSOP16...TR, TSOP96...TR)



Drawing-No.: 9.700-5260.01-4

Issue: 2; 25.09..01

16585

## TAPING VERSION TSOP..TR (SIDE VIEW) DIMENSIONS in millimeters

B. Heimdall (TSSP7...., TSOP75...TR, TSOP77...TR, TSSP7....TR, TSOP15...TR, TSOP95...TR)



Drawing-No.: 9.700-5337.01-4  
Issue: 2; 06.10.15



technical drawings  
according to DIN  
specifications

## TAPING VERSION TSOP..TR (SIDE VIEW) DIMENSIONS in millimeters

C. Heimdall without lens (TSOP75...WTR, TSOP77...WTR, TSSP...WTR, TSOP15...WTR, TSOP95...WTR)



Drawing-No.: 9.700-5342.01-4  
Issue: 2; 12.06.13

technical drawings according to DIN specifications

### LEADER AND TRAILER DIMENSIONS in millimeters



### COVER TAPE REEL STRENGTH

According to DIN EN 60286-3

0.1 N to 1.3 N

300 mm/min.  $\pm$  10 mm/min.

165° to 180° peel angle

### LABEL

#### Standard bar code labels for finished goods

The standard bar code labels are product labels and used for identification of goods. The finished goods are packed in final packing area. The standard packing units are labeled with standard bar code labels before transported as finished goods to warehouses. The labels are on each packing unit and contain Vishay Semiconductor GmbH specific data.

VISHAY SEMICONDUCTOR GmbH STANDARD BAR CODE PRODUCT LABEL (finished goods)		
PLAIN WRITING	ABBREVIATION	LENGTH
Item-description	-	18
Item-number	INO	8
Selection-code	SEL	3
LOT-/serial-number	BATCH	10
Data-code	COD	3 (YWW)
Plant-code	PTC	2
Quantity	QTY	8
Accepted by	ACC	-
Packed by	PCK	-
Mixed code indicator	MIXED CODE	-
Origin	xxxxxxx+	Company logo
LONG BAR CODE TOP	TYPE	LENGTH
Item-number	N	8
Plant-code	N	2
Sequence-number	X	3
Quantity	N	8
Total length	-	21
SHORT BAR CODE TOP	TYPE	LENGTH
Selection-code	X	3
Data-code	N	3
Batch-number	X	10
Filter	-	1
Total length	-	17





### DRY PACKAGING

The reel is packed in an anti-humidity bag to protect the devices from absorbing moisture during transportation and storage.



15973

### RECOMMENDED METHOD OF STORAGE

Dry box storage is recommended as soon as the aluminum bag has been opened to prevent moisture absorption. The following conditions should be observed, if dry boxes are not available:

- Storage temperature 10 °C to 30 °C
- Storage humidity ≤ 60 % RH max.

After more than 72 h under these conditions moisture content will be too high for reflow soldering.

In case of moisture absorption, the devices will recover to the former condition by drying under the following condition:

- 192 h at 40 °C + 5 °C / - 0 °C and < 5 % RH (dry air / nitrogen) or
- 96 h at 60 °C + 5 °C and < 5 % RH for all device containers or
- 24 h at 125 °C + 5 °C not suitable for reel or tubes.

An EIA JEDEC® standard JSTD-020 level 4 label is included on all dry bags.



22522

EIA JEDEC standard JSTD-020 level 4 label is included on all dry bags

### ESD PRECAUTION

Proper storage and handling procedures should be followed to prevent ESD damage to the devices especially when they are removed from the antistatic shielding bag. Electrostatic sensitive devices warning labels are on the packaging.

### VISHAY SEMICONDUCTORS STANDARD BAR CODE LABELS

The Vishay Semiconductors standard bar code labels are printed at final packing areas. The labels are on each packing unit and contain Vishay Semiconductors specific data.



16962

### OUTER PACKAGING

The sealed reel is packed into a pizza box.

CARTON BOX DIMENSIONS in millimeters			
	<b>THICKNESS</b>	<b>WIDTH</b>	<b>LENGTH</b>
Pizza box (SMD and heimdall) (taping in reels)	50	340	340

22127



## **Disclaimer**

ALL PRODUCT, PRODUCT SPECIFICATIONS AND DATA ARE SUBJECT TO CHANGE WITHOUT NOTICE TO IMPROVE RELIABILITY, FUNCTION OR DESIGN OR OTHERWISE.

Vishay Intertechnology, Inc., its affiliates, agents, and employees, and all persons acting on its or their behalf (collectively, "Vishay"), disclaim any and all liability for any errors, inaccuracies or incompleteness contained in any datasheet or in any other disclosure relating to any product.

Vishay makes no warranty, representation or guarantee regarding the suitability of the products for any particular purpose or the continuing production of any product. To the maximum extent permitted by applicable law, Vishay disclaims (i) any and all liability arising out of the application or use of any product, (ii) any and all liability, including without limitation special, consequential or incidental damages, and (iii) any and all implied warranties, including warranties of fitness for particular purpose, non-infringement and merchantability.

Statements regarding the suitability of products for certain types of applications are based on Vishay's knowledge of typical requirements that are often placed on Vishay products in generic applications. Such statements are not binding statements about the suitability of products for a particular application. It is the customer's responsibility to validate that a particular product with the properties described in the product specification is suitable for use in a particular application. Parameters provided in datasheets and / or specifications may vary in different applications and performance may vary over time. All operating parameters, including typical parameters, must be validated for each customer application by the customer's technical experts. Product specifications do not expand or otherwise modify Vishay's terms and conditions of purchase, including but not limited to the warranty expressed therein.

Except as expressly indicated in writing, Vishay products are not designed for use in medical, life-saving, or life-sustaining applications or for any other application in which the failure of the Vishay product could result in personal injury or death. Customers using or selling Vishay products not expressly indicated for use in such applications do so at their own risk. Please contact authorized Vishay personnel to obtain written terms and conditions regarding products designed for such applications.

No license, express or implied, by estoppel or otherwise, to any intellectual property rights is granted by this document or by any conduct of Vishay. Product names and markings noted herein may be trademarks of their respective owners.

Компания «Life Electronics» занимается поставками электронных компонентов импортного и отечественного производства от производителей и со складов крупных дистрибьюторов Европы, Америки и Азии.

С конца 2013 года компания активно расширяет линейку поставок компонентов по направлению коаксиальный кабель, кварцевые генераторы и конденсаторы (керамические, пленочные, электролитические), за счёт заключения дистрибьюторских договоров

Мы предлагаем:

- Конкурентоспособные цены и скидки постоянным клиентам.
- Специальные условия для постоянных клиентов.
- Подбор аналогов.
- Поставку компонентов в любых объемах, удовлетворяющих вашим потребностям.
- Приемлемые сроки поставки, возможна ускоренная поставка.
- Доставку товара в любую точку России и стран СНГ.
- Комплексную поставку.
- Работу по проектам и поставку образцов.
- Формирование склада под заказчика.
- Сертификаты соответствия на поставляемую продукцию (по желанию клиента).
- Тестирование поставляемой продукции.
- Поставку компонентов, требующих военную и космическую приемку.
- Входной контроль качества.
- Наличие сертификата ISO.

В составе нашей компании организован Конструкторский отдел, призванный помогать разработчикам, и инженерам.

Конструкторский отдел помогает осуществить:

- Регистрацию проекта у производителя компонентов.
- Техническую поддержку проекта.
- Защиту от снятия компонента с производства.
- Оценку стоимости проекта по компонентам.
- Изготовление тестовой платы монтаж и пусконаладочные работы.



Тел: +7 (812) 336 43 04 (многоканальный)  
Email: [org@lifeelectronics.ru](mailto:org@lifeelectronics.ru)