

Neutrik® Part Number Guide

NC3FAH1-0-X

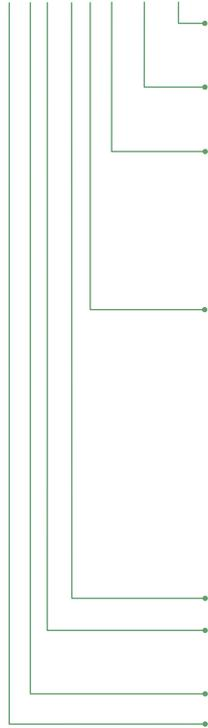

Shell:	B	Black shell, gold contacts	
	BAG	Black shell, silver contacts	
Retention:	w/o	Latch Lock	
	-0	Retention Spring	
Grounding:	0	Separate ground contact connected to shell, male only	
	1	Pin 1 & Panel & Shell connected, no separate ground contact	
	2	Separate ground contact connected to shell & panel, separate Pin 1	
	E	Additional ground contacts	
	w/o number	No ground / Shell contact (except 4 / 5 pole), female only	
Termination:	H	Horizontal PCB mount	
	HL	Lateral left PCB mount	
	HR	Lateral right PCB mount	
	L	Solder Cups	
	V	Vertical PCB mount	
	Y	IDC for wires (no ground)	
	M3	Mounting holes with M3 thread	
	M25	Mounting holes with M2.5 thread	
	-	Not applicable	
	Series:	A, AA, B, BA, D, DL, DLX, MPR, P, X, XX	
	Gender:	F	Female
M		Male	
Number of Contacts:	3, 4, 5, 6, 7, 8, 12		
Connector Type:	A	Adapter	
	AC	PowerCon®	
	B	BNC	
	C	Connector	
	E	RJ45	
	F	RCA / CINCH	
	J (MJ, RJ, SJ)	Jack	
	K	Cable Assemblies	
	L	Loudspeaker	
	M	Modules	
	O	Fiber Connector	
	P	Plugs	
	PP	Patch Panel	
	R	Circular Connector	
T	Transformer		

XLR Connectors



Content

Page

Cable Connectors:		Receptacles:	
XX Series	9	A Series	15
EMC-XLR Series	9	AA Series	15
RX Series	10	B Series	16
XX-HE	10	BA Series	16
X Series	11	A/B Series 5 pole switch	17
X-HD Series	11	D Series	17
XCC Series	12	DL Series	18
FXS Series	12	DLX Series	18
FX-SPEC Series	12	EMC	19
Technical Data	13	MPR-HD Series	19
Ordering Information	14	P Series	20
		Combo	20
		Accessories	21
		Technical Data	22
		Ordering Information A/AA Series	23
		Ordering Information B/BA Series	24
		Ordering Information D/DL/P/Combo Series	25
		Panel Cutouts, Assembly Tools	26

Introduction

The XLR connector series is probably together with the Speakon® series Neutrik's most known product range and has due to the simple but striking concept been one of the most important keys to our great success.

We introduced the first XLR version more than 25 years ago, meanwhile it became the worldwide accepted standard.

XLR connectors are widely used in various applications of the professional audio world. Whether as microphone connector, on lighting applications or any kind of sound equipment, the XLR is all over the entertainment industry.

Keyfeatures are:

- Reliable and robust
- Easy to assemble, simple to use
- Excellent cable protection and retention
- Colour coding
- Available in 3 to 7 pole

The reason for the outstanding success of the series is in accompany with these features a constant and peerless quality.

Q u a l i t y T h i n k i n g

XLR Cable Connectors



XX Series



NC3FXX

NC3MXX-B

- The next generation of the worldwide accepted standard
- Unique cage type female contact - increases conductivity
- Female contact with "solder stop" for ease soldering
- Male connector without locking "window" - more stringent housing, increases durability
- Improved chuck type strain relief - increases retention force and makes assembly easier and faster
- New ground contact - excellent contact integrity between chassis and cable connector
- Customized branding using translucent ring
- Sleek and ergonomic design - valuable and handy

NC*FXX

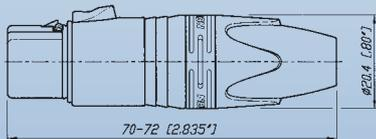

NC*MXX

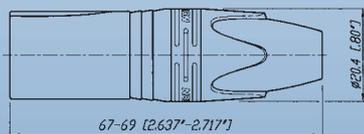

* ... 3 - 7 contacts



EMC-XLR Series



NC3FXX-EMC

NC3MXX-EMC

- 3-pole male / female XLR cable connector with integrated capacitive shield to shell connection to avoid RF-interference and LF-noise
- 360° shield contact on female connector ensures best possible shielding and chassis contact
- Patent pending

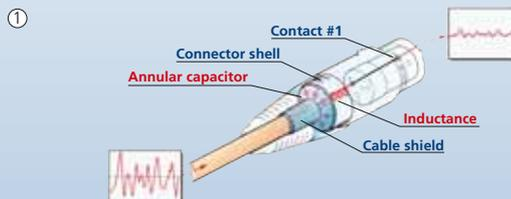

- ① Design guarantees a continuous RF-shield connection but avoids ground loops (no LF-shield connection)
- ② Circular capacitor enables low-inductive shield connection to connector housing
- ③ Cable shield - PIN 1 connection includes EMI suppression bead (blocks high frequencies)

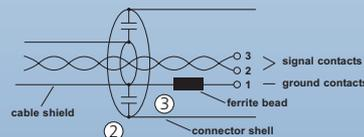

- Quality Design

XLR Cable Connectors



RX Series

XX-HE Series

NEW



NC3FRX

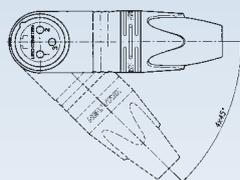

Outlet position

NEW



NC3FXX-HE



NC3MXX-HE

- Right angle version of the XX Series - only 20 mm wide
- Extra slim right-angle connector
- Neutrik chuck type strain relief
- 5 selectable cable outlet positions

- Exclusive version of standard XX Series
- Valuable velour chromium plating
- Extra high temperature resistant insulator material
- Machined female contacts

NC*FRX

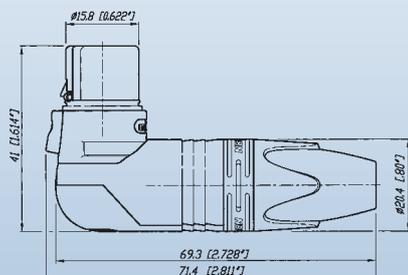

NC*MRX

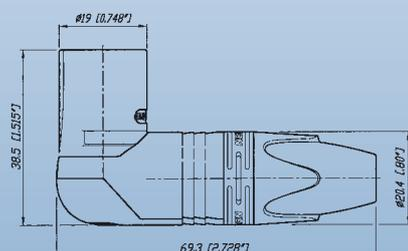

NC3FXX-HE

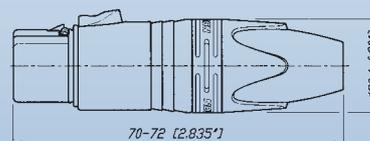

NC3MXX-HE

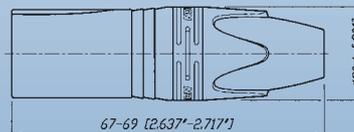

* ... 3 - 7 contacts

Look for the Logo



XLR Cable Connectors



X Series

X-HD Series



NC3FX



NC3MX



NC5FX-HD



NC4MX-HD

- The worldwide accepted XLR connector standard
- Rugged diecast shell
- Compact design (shortest available XLR cable connector)
- Time saving assembly – 4 parts only, no screws
- Neutrik unique chuck type strain relief
- Gold or silver plated contacts
-  UL Recognized components
- Available in 3 - 7 pin configuration

- "Heavy duty" cable connectors for outdoor use
- All metal design, male stainless steel
- NC*FX-HD mates with NC*MPR-HD chassis connector and NC*MX-HD
- Dust and water protected according IP 65 in mated condition
- Available in 3 - 5 pin configuration

NC*FX

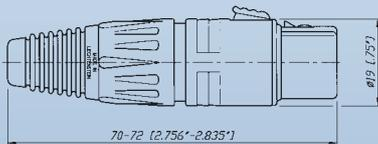

NC*MX

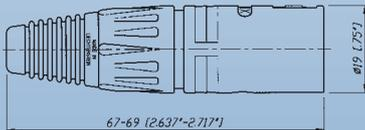

NC*FX-HD

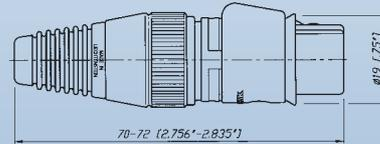

NC*MX-HD

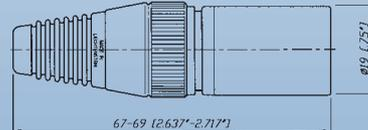

* ... 3 - 7 contacts

* ... 3 - 5 contacts

t o i d e n t i f y t h e o r i g i n a l

XLR Cable Connectors



XCC Series



FXS Series



FX-SPEC Series



NC3FXCC

- 3 pole cable connector with a circumferential shield contact for best EMI protection
- Featuring a coaxial ground spring and coaxial hex crimp ferrule at the cable entrance for proper and reliable transition of the cable shield to the shell
- Zebra coding ring to indicate digital AES signals included

NC3FXCC

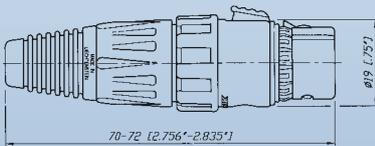

NC3MXCC

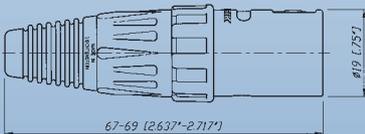

NC3FXS

- FX connector with noiseless ON-OFF switch short-circuiting contacts 2 + 3
- For use on a microphone without switch

NC3FXS

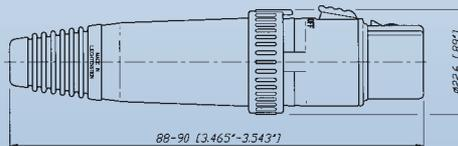

NC3FX-SPEC

- Solid female cable connector with locking ring for highest security of connection
- Uninterrupted EMI protection
- Protect against accidental disconnects
- Thief-proof, grub screw secure connector onto microphone or gooseneck
- Avoids movements and noises

NC3FX-SPEC

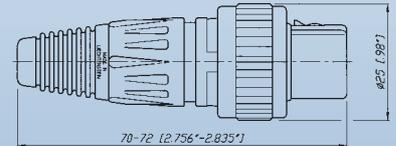

Quality Thinking

Technical Data

Specification		XX Series	EMC Series	X Series	XCC Series	X-HD Series	FXS Series	XX-HE Series	FX-SPEC Series	RX Series
Electrical										
Number of contacts		3 - 7	3	3 - 7	3	3 - 5	3	3	3	3 - 7
Contact resistance	≤ 3 mΩ	●	●	●	●	●	●	●	●	●
Insulation resistance	- initial: > 2 GΩ	●	●	●	●	●	●	●	●	●
	- after damp heat test: > 1 GΩ	●	●	●	●	●	●	●	●	●
Dielectric strength	1500 V dc	●	●	●	●	●	●	●	●	●
Cable shield-shell connection	choosable	●	-	●	-	●	-	●	●	●
	determined	-	capacitive	-	crimp	-	-	-	-	-
Shielding effectiveness	> 55 dB @ 1.3 GHz	-	●	-	●	-	-	-	-	-
Lossy ferrite bead on PIN 1		-	●	-	-	-	-	-	-	-
Rated current per contact @ 35°C										
	3 pole: 16 A	●	5 A	●	●	●	●	●	●	●
	4 pole: 10 A	●	-	●	-	●	-	-	-	●
	5, 6 pole: 7.5 A	●	-	●	-	●	-	-	-	●
	7 pole: 5 A	●	-	●	-	-	-	-	-	●
Capacitance between contacts										
	3 pole: ≤ 4 pF	●	●	●	●	●	●	●	●	●
	4, 5, 6 pole: ≤ 7 pF	●	-	●	-	●	-	-	-	●
	7 pole: ≤ 9 pF	●	-	●	-	-	-	-	-	●
Rated Voltage	50 V ac	●	●	●	●	●	●	●	●	●
Mechanical										
Lifetime > 1'000 cycles		●	●	●	●	●	●	●	●	●
Insertion / withdrawal force ≤ 20 N		●	●	●	●	●	●	●	●	●
Cable O.D. range	3.5 - 8.0 mm	●	-	●	5.4 - 6.2 mm	●	●	●	●	●
Max. wire size	3 pole: 2.5 mm ² / AWG 14	●	AWG 20	●	●	●	●	●	●	●
	4 pole: 1.5 mm ² / AWG 16	●	-	●	-	●	-	-	-	●
	5, 6, 7 pole: 1.0 mm ² / AWG 18	●	-	●	-	●	-	-	-	●
Crimp tool:	6.5 mm Hex die (size "E" acc. to IEC 60803)	-	-	-	●	-	-	-	-	-
Material										
Shell	Zinc diecast (ZnAl4Cu1)	●	●	●	●	-	●	●	●	●
	(gal Ni or black Cr)	●	gal Ni	●	●	black Cr	●	●	●	●
	Stainless steel	-	-	-	-	-	-	-	-	-
Insert	Polyamide PA 6.6 30% GR	●	●	●	●	●	●	●	●	●
Contacts	- female 3 pole: Bronze (CuSn8)	●	●	●	●	●	●	●	●	●
	- female 4 - 7 pole & male: Brass (CuZn39Pb3)	●	-	●	●	●	-	●	-	●
Contact surface	Silver gal 2 μm Ag	●	Au	●	●	Au	●	●	●	●
	or Gold gal 0.2 μm Au hard alloy over 2 μm Ni	-	-	-	-	-	-	-	-	-
Latch lock	St3K32 (latch) / Ck 67 (spring)	-	-	●	●	●	●	-	●	-
Strain-relief clamp	Zinc diecast (ZnAl4Cu1)	●	●	-	-	-	-	●	-	●
	POM	●	●	●	●	●	●	●	●	●
Bushing	PA / PU	●	●	●	●	PU	PU	●	●	●
Circumferential ground spring	Bronze (CuSn6), Ni plated	-	●	-	●	-	-	-	-	-
Crimp ferrule	Brass (CuZn39Pb3), Ni plated	-	-	-	●	-	-	-	-	-
Coding ring	Polyamide PA 6 15% GR	-	-	-	●	-	-	-	-	-
Sealing jacket	EPDM	-	-	-	-	●	-	-	-	-
Securing ring	Brass (CuZn39Pb3)	-	-	-	-	-	-	-	●	-
Environmental										
Operating temperature	-30°C to +80°C	●	●	●	●	●	●	●	●	●
Flammability	UL 94 HB	●	●	●	●	●	●	●	●	●
Protection class	IP 40	●	●	●	●	IP 65	●	●	●	●
Solderability complies with IEC 68-2-20		●	●	●	●	●	●	●	●	●
Manufacturing Standard IEC 61076-2-103		●	●	●	●	●	●	●	●	●

- Quality Design

Ordering Information

Ordering Information for Cable Connectors

Female	Male	Shell	Contact - plating	3 pole	4 pole	5 pole	6 pole	7 pole
XX Series								
NC*FXX	NC*MXX	Nickel	Silver	•	•	•	•	•
NC*FXX-B	NC*MXX-B	Black Cr	Gold	•	•	•	•	•
NC*FXX-BAG	NC*MXX-BAG	Black Cr	Silver	•	•	•	•	•
NC3FXX-**-D ¹	NC3MXX-**-D ¹	Nickel / Black Cr	Silver / Gold	•	-	-	-	-
XX-EMC Series								
NC3FXX-EMC	NC3MXX-EMC	Nickel	Gold	•	-	-	-	-
NC3FXX-EMC-B	-	Black Cr	Gold	•	-	-	-	-
X Series								
NC*FX	NC*MX	Nickel	Silver	•	•	•	•	•
NC*FX-B	NC*MX-B	Black Cr	Gold	•	•	•	•	•
NC*FX-BAG	NC*MX-BAG	Black Cr	Silver	•	•	•	•	•
NC3FX-**-D ¹	NC3MX-**-D ¹	Nickel / Black Cr	Silver / Gold	•	-	-	-	-
NC6FSX ²	NC6MSX ²	Nickel	Silver	-	-	-	•	-
NC6FSX-B ²	NC6MSX-B ²	Black Cr	Gold	-	-	-	•	-
NC6FSX-BAG ²	NC6MSX-BAG ²	Black Cr	Silver	-	-	-	•	-
RX Series								
NC*FRX	NC*MRX	Nickel	Silver	•	•	•	•	•
NC*FRX-B	NC*MRX-B	Black Cr	Gold	•	•	•	•	•
NC*FRX-BAG	NC*MRX-BAG	Black Cr	Silver	•	•	•	•	•
XX-HE Series								
NC3FXX-HE	NC3MXX-HE	Velour Chromium	Gold	•	-	-	-	-
FXS Series								
NC3FXS	-	Nickel	Gold	•	-	-	-	-
NC3FXS-B	-	Black Cr	Gold	•	-	-	-	-
FX-SPEC Series								
NC3FX-SPEC	-	Black Cr	Silver	•	-	-	-	-
XCC Series								
NC3FXCC	NC3MXCC	Nickel	Gold	•	-	-	-	-
X-HD Series								
NC*FX-HD	NC*MX-HD	Nickel	Gold	•	•	•	-	-
NC3FX-HD-B	NC3MX-HD-B	Metal Black	Gold	•	-	-	-	-

Accessories and Assembly Tools

Detailed information on page 21 and 26.

* Number of Contacts

** Nickel or Black

-D¹ Bulk packed, to be ordered in multiples of 100 pcs.

² Switchcraft Equivalent

Look for the Logo



XLR Chassis Connectors

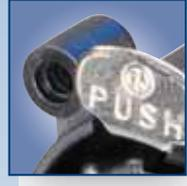

A Series

AA Series



NC3FAH1



NC3MAHR



NC3FAAV2



NC3MAAH-1

- Smallest XLR receptacles, highest packing density
- Plastic housing, steel retention lug
- Fork type female contacts
- Polished contact areas and hard gold plating
- Various grounding options

- Front panel cutout and PCB layout 100% compatible to the A Series
- Most cost-effective series
- "Tulip" type female contact design with high contact pressure
- Selective gold plated contact and PCB termination area for best conductivity and solderability
- Plastic housing flammability UL 94 HB

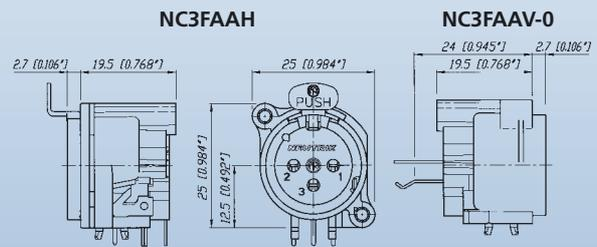
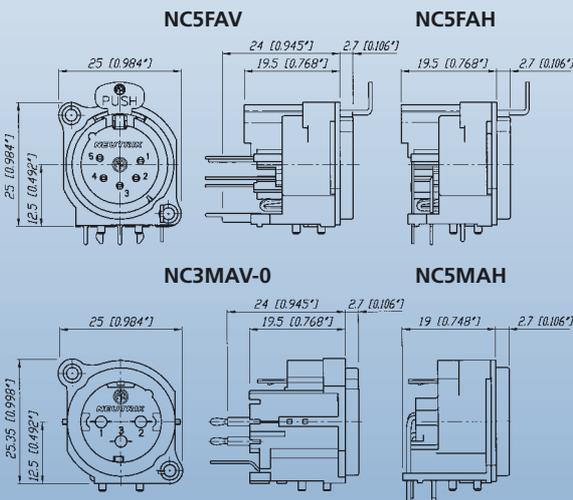

Grounding Options (A / AA / B / BA Series):

- 1 ... Pin 1 & Panel & Shell connected, no separate ground contact
- 2 ... Separate ground contact connected to shell & panel, separate Pin 1 w/o number: No ground / Shell contact (except 4 / 5 pole)

t o i d e n t i f y t h e o r i g i n a l

XLR Chassis Connectors



B Series

BA Series



NC3FBV



NC3MBV

NEW



NC3FBAV2



NC3MBAH

- Same as A Series with exception of a metal mounting flange enabling continuous circumferential ground contact to chassis for best EMC and RF protection
- Fastening with B-screw

- More economical version of B Series with modified metal flange
- Fastening with A-screw
- 3, 4 and 5 pole version

NC3FBY

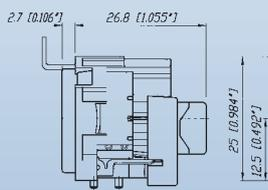

NC3FBH1

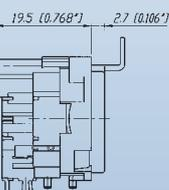

NC3FBAV

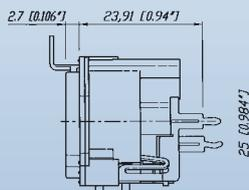

NC3FBAH

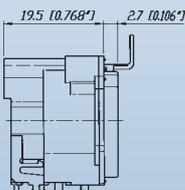

NC3MBH

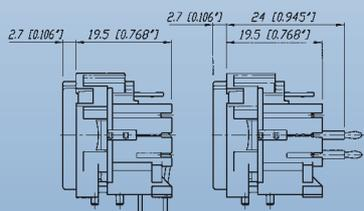

NC3MBV

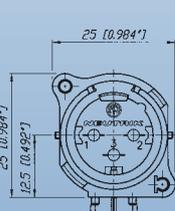

NC3MBAV

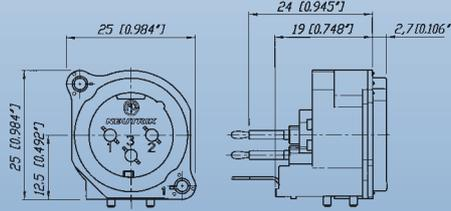

NC3MBAH

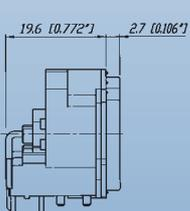

Quality Thinking

XLR Chassis Connectors

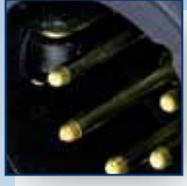

A/B Series 5-pole switch

D Series



NC5FAV-SW



NC5MAV-SW



NC3FD-V



NC3MDM3-V

- A and B Series 5 pole connector with additional switch
- Normally open, normally closed (NO - NC) contact
- Switch activated by mating XLR cable connector
- Available in 5 pole, 3 or 4 pole on request

Inserting (Schematic):

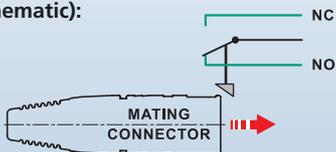

- "D" Shape metal shell
- Optimal RF protection using 3 shield contacts
- Horizontal and vertical PCB mount with separate ground contact
- Mounting holes with M3 threads available
- 2 piece connector, insert is removable from shell
- Front locked / unlocked insert
- Special version with screw termination

NC5FAV-SW

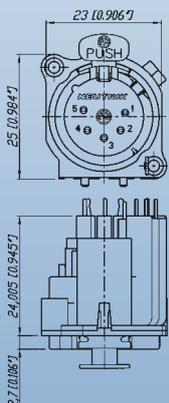

NC5MBV-SW

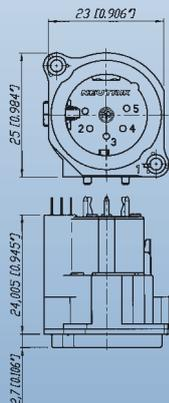

NC3FD-V / NC3FD-H

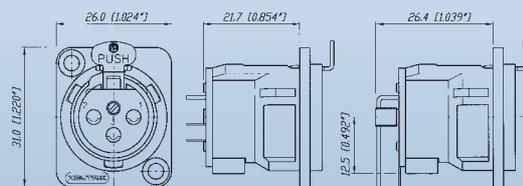

NC3MD-V / NC3MD-H

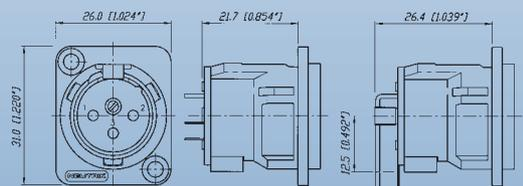

- Quality Design

XLR Chassis Connectors



DL Series



NC3FD-L-1



NC4MDM3-H

- Unified "D" metal shell
- Solder cups on 3 - 7 pole version
- Additional PCB mount on 4 and 5 pole
- Front and rear mountable
- High End "-HE" version available with machined female contacts, temperature resistant insulator and valuable velour chromium plating

NC3FD-L-1

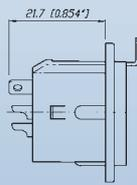
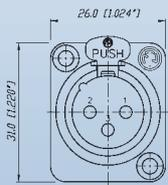

NC*FDM3-H

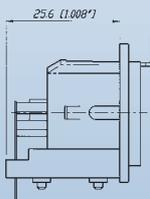

NC3MD-L-1

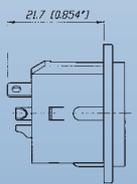
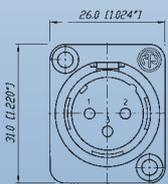

NC*MDM3-H

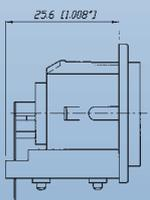

* ... 3 - 5 contacts

DLX Series

NEW



NC3FD-LX



NC3MD-LX

- Next generation of the popular DL Series with greater functionality
- All metal housing works in combination with a new duplex ground contact yielding the best RF protection and ground conductivity in a chassis mount XLR
- Male connector's retention bar replaces plastic design with all metal version
- Unique cage type female contacts on 3 pole version for increased conductivity
- Machined male and female contacts on four to seven pin versions
- D-style housing provides installation compatibility with industry standard D mounting dimensions

NC3FD-LX

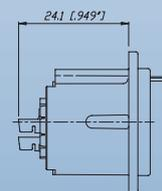
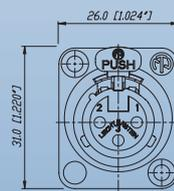

NC*MD-LX

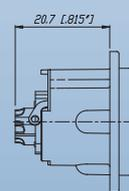

* ... 3 - 7 contacts

Quality Thinking

XLR Chassis Connectors



EMC

MPR-HD Series

NEW



NC3FDX-EMC-SPEC

- 3-pole female XLR chassis connector with integrated capacitive shield to shell connection to avoid RF-interference and LF-noise
- 360° shield contact on female connector ensures best possible shielding and chassis contact
- D flange chassis for panel mount applications
- Includes the locking nut of the NC3FX-SPEC for secure fastening of a gooseneck for instance
- Special flange for large openings available
- Patent pending

Detailed information of RF-shielding see page 9 - EMC cable-connector.

NC3FDX-EMC-SPEC

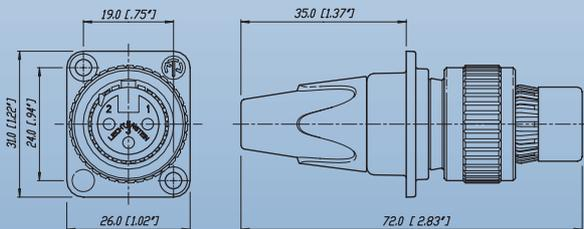

NEW



NC3MPR-HD



NC5MPR-HD

- IP 65 - in combination with NC*FX-HD cable connectors
- Perfect for outdoor applications
- Sealing gasket for water tight panel mount
- Gold plated contacts



NC5FX-HD

NC5MPR-HD

NC3MPR-HD

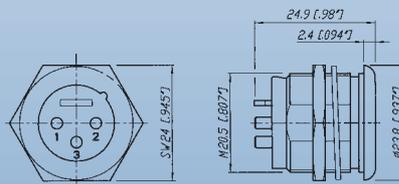

* ... 3 - 5 contacts

- Quality Design

XLR Chassis Connectors



P Series

Combo Series



NC4FP-1



NC6MP-B



NCJ9FI-V



NCJ10FI-S

- Smallest available hard wiring receptacles with large solder cups
- Short female receptacle
- Compatible with Switchcraft DxM, Dx F; Cannon XLRx31, XLRx32
- 6 pole version available with Switchcraft contact arrangement (NC6FSP-1, NC6MSP)

- Combined XLR receptacle and 1/4" phone jack
- Attractive "front end" design
- Saves rack space by combining 2 connectors in one housing
- Horizontal or vertical PCB mounting or hard wire soldering
- Fully normalised
- Stereo or mono version
- Very low conductor capacitance, therefore suitable for digital audio
- Fastening: Self-tapping Plastite® screws with thread 2.9 x 1.06 and tri-rondular configuration (A screw)
- Front dimension: 30 x 27 mm

NC3FP-1

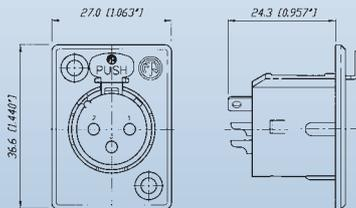

NC3MP

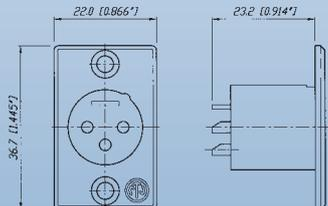

NCJ10FI-H

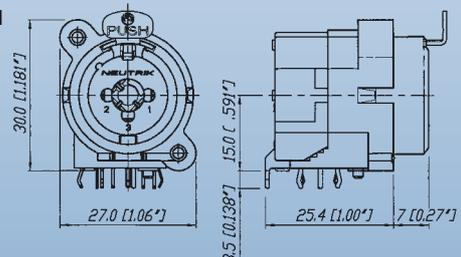

Quality Thinking

Accessories

Colour Coded Accessories

Part No.	Description	Black	Brown	Red	Orange	Yellow	Green	Blue	Violet	Grey	White
		0	1	2	3	4	5	6	7	8	9
XLR Cable Connectors											
BSX-*	Coloured bushing for X Series										
BXX-*	Coloured bushing for XX Series										
XCR-*	Coloured coding ring for X Series										
XXR-*	Coloured coding ring for XX Series										
XLR Chassis Connectors											
ACRF-*	Coloured ring for female 4 + 5 pole A Series and 3 pole BA Series										
ACRM-*	Coloured ring for male 4 + 5 pole A Series and 3 pole BA Series										
DSS-*	Lettering plate for D Series										

Accessories

XLR Cable Connectors				
XXCR	Translucent coding ring for XX Series			Example
XCCR	Coding ring for X Series digital signals			
XLR Chassis Connectors				
DBA	Dummy-plate for D Series panel cut outs			
SCD*	Rubber sealing cover for female and male D Series			SCDF SCDM
SC*	Rubber sealing cap for female and male XLR receptacles			SCF SCM
SFAV	Rubber frame for A / B Series to mount between front plate and rear vertical print			SFAV Example
A-Screw-1-8	Plastite® screw 2.9 x 8**			A Screw B Screw
B-Screw-1-8	TAPTITE® screw 2.5 x 8*			

** ... Minimum order quantity of 1000 pcs.

- Quality Design

Technical Data

Specification		A Series	AA Series	B Series	BA Series	D Series	DL/DLX Series	MPR-HD Series	P Series	Combo Series
Electrical										
Number of contacts		3 - 5	3	3 - 5	3	3	3 - 7	3 - 5	3 - 7 (6**)	5 - 10
Contact resistance	≤ 5 mΩ	●	≤ 8 mΩ	●	●	●	●	●	●	≤ 10 mΩ
Insulation resistance	- initial: > 2 GΩ	●	●	●	●	●	●	●	●	●
	- after damp heat test: > 1 GΩ	●	●	●	●	●	●	●	●	> 500 MΩ
Dielectric strength	1500 V dc	●	●	●	●	●	●	●	●	●
Rated voltage	50 V ac	●	●	●	●	●	●	●	●	●
Rated current per contact										
	3 pole: 6 A	●	●	●	●	●	16 A	16 A	16 A	-
	4 pole: 6 A	●	-	●	-	-	10 A	10 A	10 A	-
	5, 6 pole: 3 A	●	-	●	-	-	7.5 A	7.5 A	7.5 A	-
	7 pole: 5 A	-	-	-	-	-	●	-	●	-
Combo XLR + Jack contact	7.5 A	-	-	-	-	-	-	-	-	●
Capacitance between contacts										
	3 pole: ≤ 7 pF	●	●	●	●	-	≤ 4 pF	≤ 4 pF	≤ 4 pF	≤ 2 pF
	4, 5, 6 pole: ≤ 7 pF	●	-	●	-	-	●	●	●	-
	7 pole: ≤ 9 pF	-	-	-	-	-	●	-	●	-
Mechanical										
Lifetime > 1'000 mating cycles		●	●	●	●	●	●	●	●	●
Insertion / withdrawal force	≤ 20 N	●	●	●	●	●	●	●	●	●25 N
Retention method										
	- standard: latch lock	●	●	●	●	●	●	●	●	●(XLR)
	- "0" Version: ≥ 20 N separating force	●	●	●	●	●	●	●	●	●25 N
Material										
Insert	Polyamide PA 6.6 30% GR	●	●	●	●	●	●	●	●	●
Shell	Zinc diecast ZnAl4Cu1	-	-	-	-	●	●	●	●	-
	(gal Ni or black Cr plated)	-	-	-	-	●	●	Ni plated	●	-
Ring	Zinc diecast ZnAl4Cu1	-	-	●	●	-	-	-	-	-
Contacts	- female 3 pole: Bronze CuSn6	●	●	●	●	●	●	-	●	●
	4 - 5 pole: Bronze CuSn6	●	-	●	-	-	-	-	-	-
	4 - 7 pole: Brass CuZn39Pb3	-	-	-	-	-	●	-	●	-
	- male: Brass CuZn35Pb2	●	●	●	●	●	●	●	●	-
Contact surface	gal 0.2 µm AuCo over 2 µm NiP15 (Tribor®)	●	●	●	●	-	-	-	-	●
	gal 2 µm Ag or gal 0.2 µm Au hard alloy over 2 µm Ni	-	-	-	-	●	●	Au	●	-
Latch lock & spring	Ck 67 steel, treated	●	●	●	●	●	●	-	●	●
Environmental										
Operating temperature	-30°C to +80°C	●	●	●	●	●	●	●	●	●
Protection class	IP 40	●	●	●	●	●	●	IP 65	●	●
Flammability	UL 94 HB	●	●	●	●	●	●	●	●	●
	UL 94 V-0	3 pole	-	3 pole	-	-	-	-	-	-
Solderability complies with IEC 68-2-20		●	●	●	●	●	●	●	●	●
Mounting screw		A	A	1)	A	-	-	-	-	A
Colour coding		ACR-*	-	-	ACR-*	DSS	DSS	-	-	-
		(4 + 5 pole only)								
1) B Series 3 pole connectors > B-screw, 4 & 5 pole versions > A-screw										
** P Series male 3 - 6 pole										

Quality Thinking

Ordering Information for Receptacles

Female	Male	Shell	Contact	3 pole	4 pole	5 pole	Female	Male	Shell	Contact	3 pole
A Series							AA Series				
NC*FAH-D		Black Plastic	Gold	-	●	●	NC3FAAH	NC3MAAH	Black Plastic	Gold	●
	NC*MAH	Black Plastic	Gold	●	●	●	NC3FAAH-0		Black Plastic	Gold	●
NC*FAH-0		Black Plastic	Gold	●	●	●	NC3FAAH1	NC3MAAH-1	Black Plastic	Gold	●
	NC3MAH-0	Black Plastic	Gold	●	-	-	NC3FAAH1-0		Black Plastic	Gold	●
NC3FAHL-0		Black Plastic	Gold	●	-	-		NC3MAAH-0	Black Plastic	Gold	●
NC3FAHR-0		Black Plastic	Gold	●	-	-	NC3FAAH2		Black Plastic	Gold	●
NC3FAH1-D	NC3MAH-1	Black Plastic	Gold	●	-	-	NC3AAH2-0		Black Plastic	Gold	●
NC3FAH1-0		Black Plastic	Gold	●	-	-	NC3FAAV	NC3MAAV	Black Plastic	Gold	●
NC3FAHL1-D		Black Plastic	Gold	●	-	-	NC3FAAV-0		Black Plastic	Gold	●
	NC3MAHL	Black Plastic	Gold	●	-	-	NC3FAAV1	NC3MAAV-1	Black Plastic	Gold	●
NC3FAHL1-0		Black Plastic	Gold	●	-	-	NC3AAV1-0		Black Plastic	Gold	●
NC3FAHR1-D		Black Plastic	Gold	●	-	-		NC3MAAV-0	Black Plastic	Gold	●
	NC3MAHR	Black Plastic	Gold	●	-	-	NC3FAAV2		Black Plastic	Gold	●
NC3FAHR1-0		Black Plastic	Gold	●	-	-	NC3FAAV2-0		Black Plastic	Gold	●
NC3FAH2-D		Black Plastic	Gold	●	-	-					
NC3FAH2-0		Black Plastic	Gold	●	-	-					
NC3FAHR2-D		Black Plastic	Gold	●	-	-					
NC3FAHR2-0		Black Plastic	Gold	●	-	-					
NC*FAV-D		Black Plastic	Gold	-	●	●					
	NC*MAV	Black Plastic	Gold	●	●	●					
NC*FAV-0		Black Plastic	Gold	●	●	●					
	NC3MAV-0	Black Plastic	Gold	●	-	-					
NC3FAV1-D	NC3MAV-1	Black Plastic	Gold	●	-	-					
NC3FAV1-0		Black Plastic	Gold	●	-	-					
NC3FAV2-D		Black Plastic	Gold	●	-	-					
NC3FAV2-0		Black Plastic	Gold	●	-	-					
NC3FAY-D	NC3MAY	Black Plastic	Gold	●	-	-					
NC3FAY-0		Black Plastic	Gold	●	-	-					
NC5FAV-SW-D	NC5MAV-SW	Black Plastic	Gold	-	-	●					

A Series comes with Push Latch disassembled, assembled Push on request.

AA Series comes with Push Latch assembled.

A / AA Series rear mount only, all PCB mount except Y version = IDC

Grounding Options

A / AA Series and B / BA Series

Female

"1"

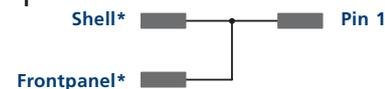

"2"

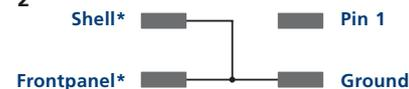

Male

w/o number

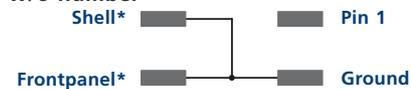

"0"

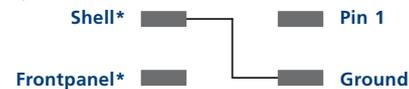

"1"

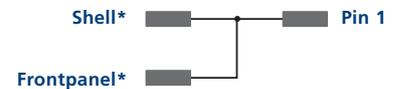

Shell* ... Contact to shell of mating connector

Frontpanel* ... Connection to frontpanel by fastening screw

Ordering Information

Ordering Information for Receptacles

Female	Male	Flange	Contact	3 pole	4 pole	5 pole	Female	Male	Flange	Contact	3 pole	4 pole	5 pole
B Series							BA Series						
NC*FBH-D		Metal	Gold	-	●	●	NC3FBAH1-D		Metal	Gold	●	-	-
	NC*MBH	Metal	Gold	●	●	●		NC3MBAH	Metal	Gold	●	-	-
NC*FBH-B-D		Black Metal	Gold	-	●	●	NC3FBAH1-0		Metal	Gold	●	-	-
	NC*MBH-B	Black Metal	Gold	●	-	●		NC3MBAH-0	Metal	Gold	●	-	-
NC3FBH1-D		Metal	Gold	●	-	-	NC3FBAH2-D		Metal	Gold	●	-	-
NC3FBH1-B-D		Black Metal	Gold	●	-	-		NC3MBAH-1	Metal	Gold	●	-	-
NC3FBHL1-D		Metal	Gold	●	-	-	NC3FBAH2-0		Metal	Gold	●	-	-
	NC3MBHL	Metal	Gold	●	-	-	NC3FBAV1-D		Metal	Gold	●	-	-
NC3FBHR1-D		Metal	Gold	●	-	-		NC3MBAV	Metal	Gold	●	-	-
NC3FBH2-D		Metal	Gold	●	-	-	NC3FBAV1-0		Metal	Gold	●	-	-
NC3FBH2-B-D		Black Metal	Gold	●	-	-		NC3MBAV-0	Metal	Gold	●	-	-
NC3FBHR2-D		Metal	Gold	●	-	-	NC3FBAV2-D		Metal	Gold	●	-	-
	NC3MBHR	Metal	Gold	●	-	-		NC3MBAV-1	Metal	Gold	●	-	-
NC*FBV-D		Metal	Gold	-	●	●	NC3FBAV2-0		Metal	Gold	●	-	-
	NC*MBV	Metal	Gold	●	●	●							
NC*FBV-B-D		Black Metal	Gold	-	●	●							
	NC*MBV-B	Black Metal	Gold	●	-	●							
NC3FBV1-D		Metal	Gold	●	-	-							
NC3FBV1-B-D		Black Metal	Gold	●	-	-							
NC3FBV2-D		Metal	Gold	●	-	-							
NC3FBV2-B-D		Black Metal	Gold	●	-	-							
NC3FBY-D	NC3MBY	Metal	Gold	●	-	-							
NC3FBY-B-D	NC3MBY-B	Black Metal	Gold	●	-	-							
NC5FBV-SW-D	NC5MBV-SW	Metal	Gold	-	-	●							
NC3FBH1-E-D	NC3MBV-E	Metal	Gold	●	-	-							
NC3FBH2-E-D		Metal	Gold	●	-	-							
	NC3MBH-E	Metal	Gold	●	-	-							
Special version for 3 pole B-Series with M2.5 mounting holes (-M25) on request.							B / BA Series comes with Push Latch disassembled, assembled Push on request.						
							B / BA Series rear mount only, all PCB mount except Y version = IDC						

Quality Thinking

Ordering Information

Panel Cutouts

A / AA / B / BA Series D / DL / DLX Series P Series Female P Series Male Combo MPR Series

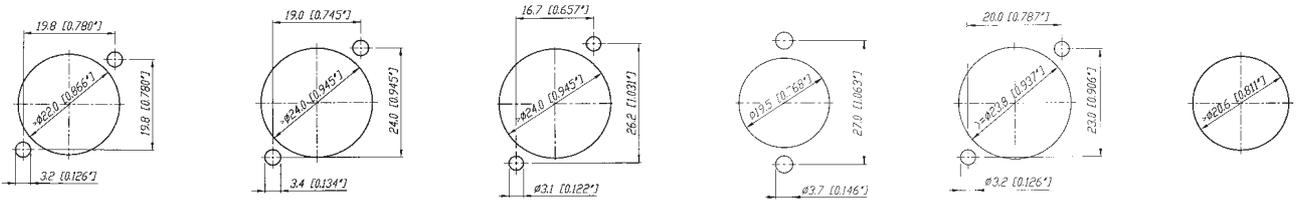

Assembly Tools

HTX Hand tool to tighten the X / XX-bushing



BTXX Assembly fixture to tightening the XX-bushing



HX-R-BNC Crimp tool for XCC Series



DIE-R-BNC-PT Crimp die for XCC Series (6.5 mm HEX)



Компания «Life Electronics» занимается поставками электронных компонентов импортного и отечественного производства от производителей и со складов крупных дистрибьюторов Европы, Америки и Азии.

С конца 2013 года компания активно расширяет линейку поставок компонентов по направлению коаксиальный кабель, кварцевые генераторы и конденсаторы (керамические, пленочные, электролитические), за счёт заключения дистрибьюторских договоров

Мы предлагаем:

- Конкурентоспособные цены и скидки постоянным клиентам.
- Специальные условия для постоянных клиентов.
- Подбор аналогов.
- Поставку компонентов в любых объемах, удовлетворяющих вашим потребностям.
- Приемлемые сроки поставки, возможна ускоренная поставка.
- Доставку товара в любую точку России и стран СНГ.
- Комплексную поставку.
- Работу по проектам и поставку образцов.
- Формирование склада под заказчика.
- Сертификаты соответствия на поставляемую продукцию (по желанию клиента).
- Тестирование поставляемой продукции.
- Поставку компонентов, требующих военную и космическую приемку.
- Входной контроль качества.
- Наличие сертификата ISO.

В составе нашей компании организован Конструкторский отдел, призванный помогать разработчикам, и инженерам.

Конструкторский отдел помогает осуществить:

- Регистрацию проекта у производителя компонентов.
- Техническую поддержку проекта.
- Защиту от снятия компонента с производства.
- Оценку стоимости проекта по компонентам.
- Изготовление тестовой платы монтаж и пусконаладочные работы.



Тел: +7 (812) 336 43 04 (многоканальный)

Email: org@lifeelectronics.ru