



| Parameters | Ratings | Units |
|---------------------|---------|----------------------|
| Load Voltage | 400 | V_P |
| Load Current | 150 | mA_{rms} / mA_{DC} |
| On-Resistance (max) | 22 | Ω |

Features

- 3750V_{rms} Input/Output Isolation
- Low Drive Power Requirements (TTL/CMOS Compatible)
- High Reliability
- Arc-Free With No Snubbing Circuits
- VDE Compatible
- FCC Compatible
- No EMI/RFI Generation
- Small 8-Pin Package
- Machine Insertable, Wave Solderable
- Surface Mount and Tape Reel Version Available.

Applications

- Telecommunications
 - Telecom Switching
 - Tip/Ring Circuits
 - Modem Switching (Laptop, Notebook, Pocket Size)
 - Hook Switch
 - Dial Pulsing
 - Ground Start
 - Ringing Injection
- Instrumentation
 - Multiplexers
 - Data Acquisition
 - Electronic Switching
 - I/O Subsystems
- Meters (Watt-Hour, Water, Gas)
- Medical Equipment-Patient/Equipment Isolation
- Security
- Aerospace
- Industrial Controls

Description

PAA110 is a 400V, 150mA, 22 Ω , dual normally open (1-Form-A) optically isolated Solid State Relay. Its efficient MOSFET switches and photovoltaic die use IXYS Integrated Circuits Division's patented OptoMOS architecture to provide 3750V_{rms} of input to output isolation. The optically coupled output is controlled by a highly efficient GaAIs infrared LED.

This performance leader provides high peak load voltage handling capability and improved peak load current handling.

Approvals

- UL Recognized Component: File E76270
- CSA Certified Component: Certificate 1175739
- EN/IEC 60950-1 Certified Component: TUV Certificate B 09 07 49410 004

Ordering Information

| Part # | Description |
|-----------|---------------------------------|
| PAA110 | 8-Pin DIP (50/Tube) |
| PAA110P | 8-Pin Flatpack (50/Tube) |
| PAA110PTR | 8-Pin Flatpack (1000/Reel) |
| PAA110S | 8-Pin Surface Mount (50/Tube) |
| PAA110STR | 8-Pin Surface Mount (1000/Reel) |

Pin Configuration

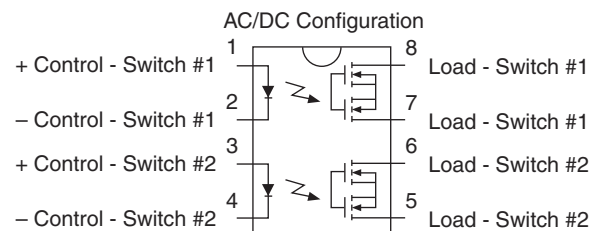

Switching Characteristics of Normally Open Devices

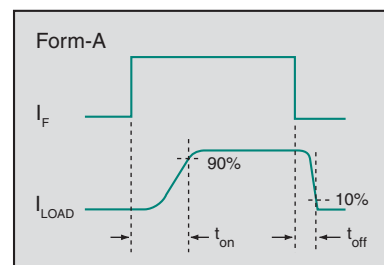

Absolute Maximum Ratings @ 25°C

| Parameter | Ratings | Units |
|--------------------------------------|-------------|------------------|
| Blocking Voltage | 400 | V _P |
| Reverse Input Voltage | 5 | V |
| Input Control Current | 50 | mA |
| Peak (10ms) | 1 | A |
| Input Power Dissipation ¹ | 150 | mW |
| Total Power Dissipation ² | 800 | mW |
| Isolation Voltage, Input to Output | 3750 | V _{rms} |
| Operational Temperature | -40 to +85 | °C |
| Storage Temperature | -40 to +125 | °C |

¹ Derate linearly 1.33 mW / °C

² Derate linearly 6.67 mW / °C

Absolute Maximum Ratings are stress ratings. Stresses in excess of these ratings can cause permanent damage to the device. Functional operation of the device at conditions beyond those indicated in the operational sections of this data sheet is not implied.

Electrical Characteristics @ 25°C

| Parameter | Conditions | Symbol | Min | Typ | Max | Units |
|-------------------------------------|--|-------------------|-----|-----|------|--------------------------------------|
| Output Characteristics | | | | | | |
| Load Current * | | | | | | |
| Continuous, AC/DC Configuration | - | I _L | - | - | 150 | mA _{rms} / mA _{DC} |
| Peak | t=10ms | I _{LPK} | - | - | ±400 | mA _P |
| On-Resistance, AC/DC Configuration | I _L =150mA | R _{ON} | - | 15 | 22 | Ω |
| Off-State Leakage Current | V _L =400V _P | I _{LEAK} | - | - | 1 | μA |
| Switching Speeds | | | | | | |
| Turn-On | I _F =5mA, V _L =10V | t _{on} | - | - | 1 | ms |
| Turn-Off | | t _{off} | - | - | 0.25 | |
| Output Capacitance | V _L =50V, f=1MHz | C _{OUT} | - | 25 | - | pF |
| Input Characteristics | | | | | | |
| Input Control Current to Activate | I _L =150mA | I _F | - | - | 5 | mA |
| Input Control Current to Deactivate | - | I _F | 0.4 | 0.7 | - | mA |
| Input Voltage Drop | I _F =5mA | V _F | 0.9 | 1.2 | 1.4 | V |
| Reverse Input Current | V _R =5V | I _R | - | - | 10 | μA |
| Common Characteristics | | | | | | |
| Input to Output Capacitance | - | C _{IO} | - | 3 | - | pF |

*NOTE: If both poles operate simultaneously, then load current must be derated in order not to exceed the package power dissipation value.

PERFORMANCE DATA @25°C (Unless Otherwise Noted)*

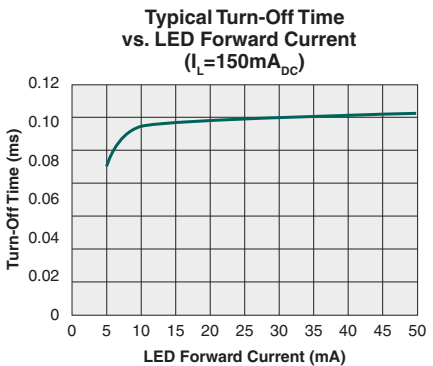
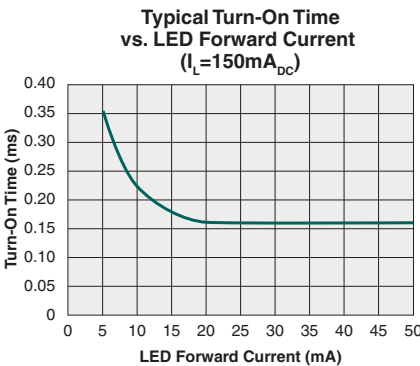
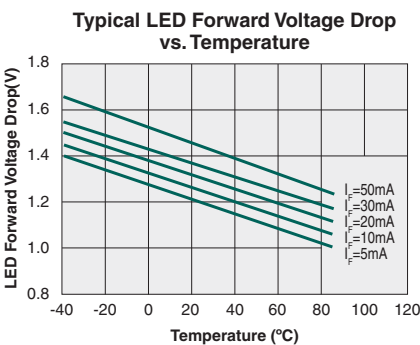
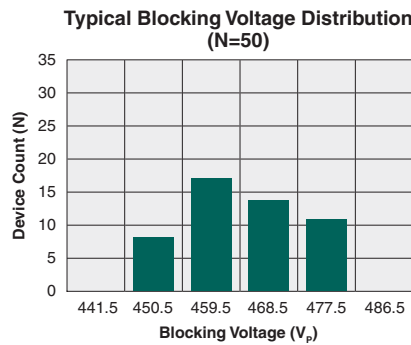
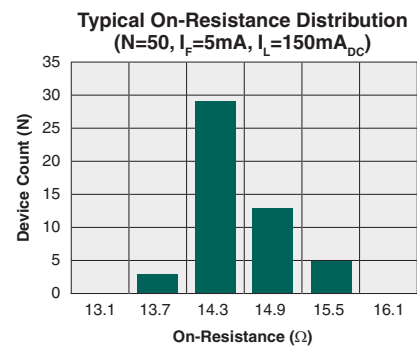
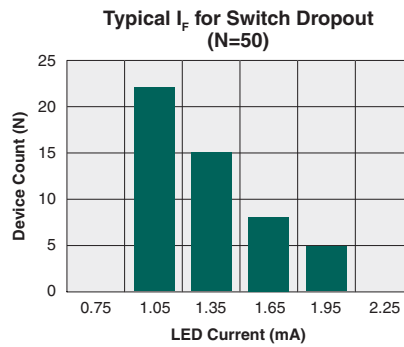
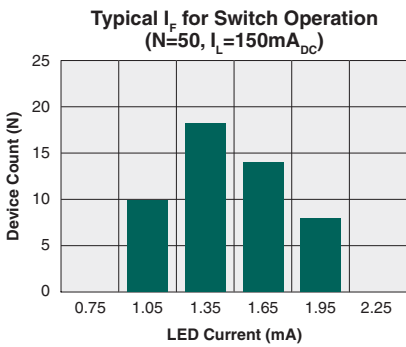
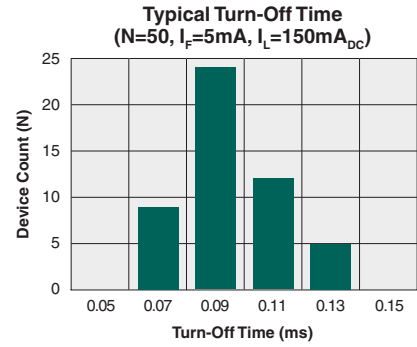
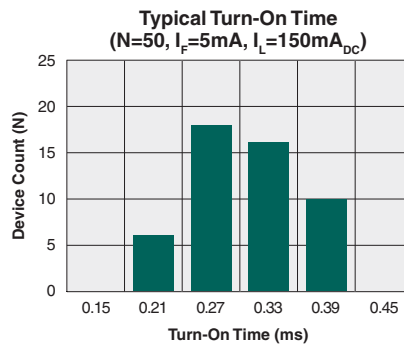
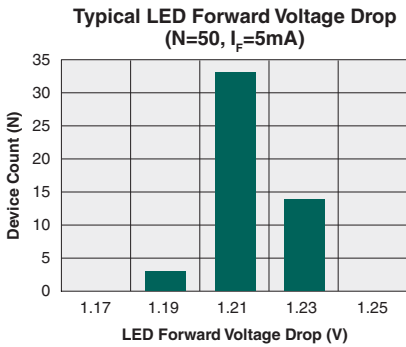

*The Performance data shown in the graphs above is typical of device performance. For guaranteed parameters not indicated in the written specifications, please contact our application department.

PERFORMANCE DATA @25°C (Unless Otherwise Noted)*

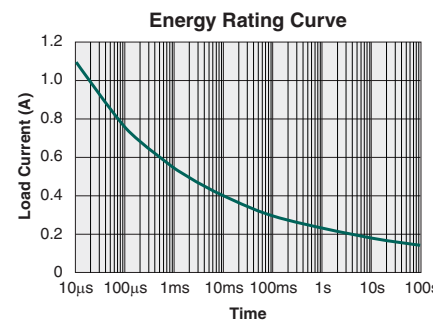
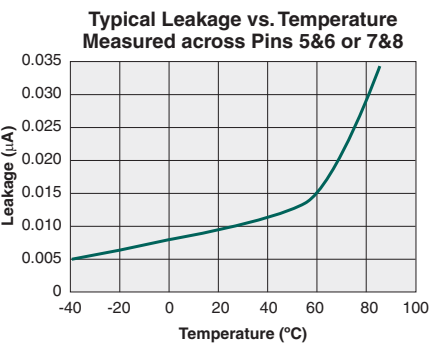
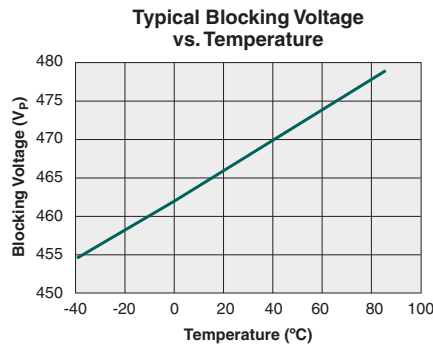
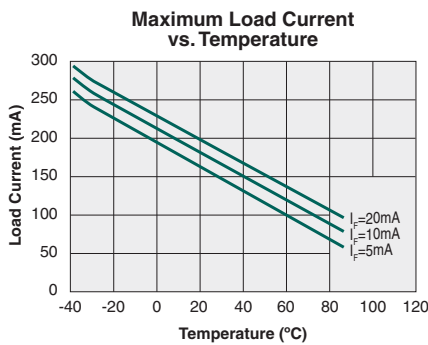
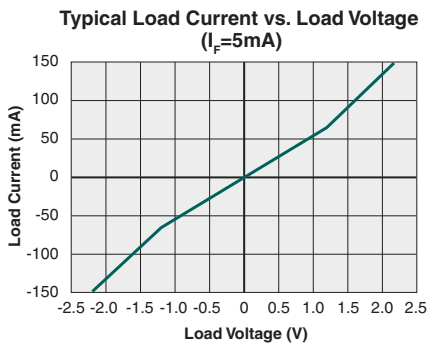
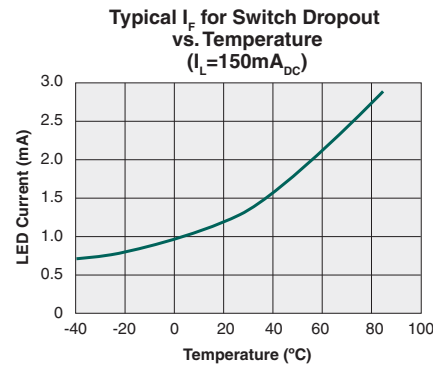
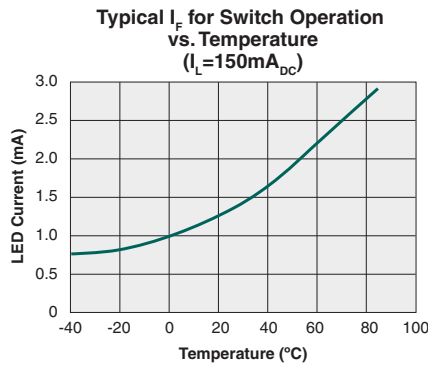
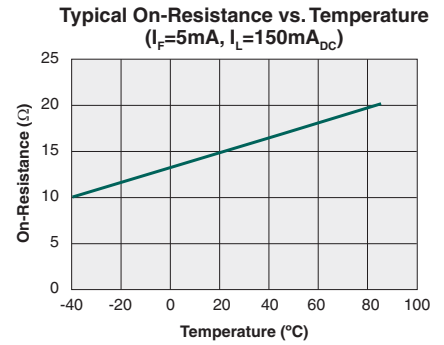
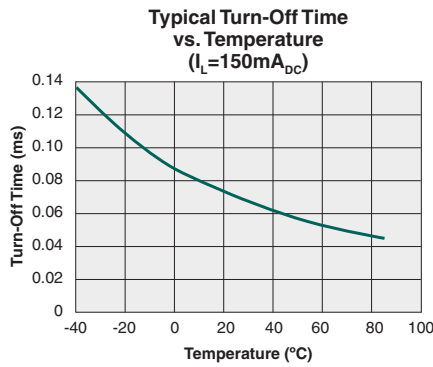
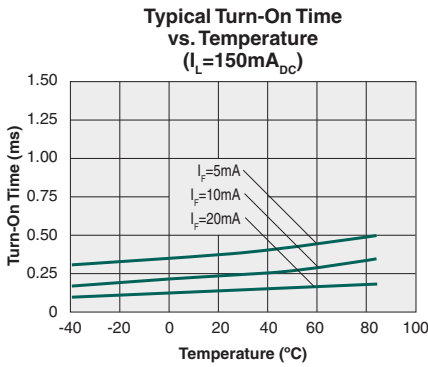

*The Performance data shown in the graphs above is typical of device performance. For guaranteed parameters not indicated in the written specifications, please contact our application department.

Manufacturing Information

Moisture Sensitivity



All plastic encapsulated semiconductor packages are susceptible to moisture ingress. IXYS Integrated Circuits Division classified all of its plastic encapsulated devices for moisture sensitivity according to the latest version of the joint industry standard, **IPC/JEDEC J-STD-020**, in force at the time of product evaluation. We test all of our products to the maximum conditions set forth in the standard, and guarantee proper operation of our devices when handled according to the limitations and information in that standard as well as to any limitations set forth in the information or standards referenced below.

Failure to adhere to the warnings or limitations as established by the listed specifications could result in reduced product performance, reduction of operable life, and/or reduction of overall reliability.

This product carries a **Moisture Sensitivity Level (MSL) rating** as shown below, and should be handled according to the requirements of the latest version of the joint industry standard **IPC/JEDEC J-STD-033**.

| Device | Moisture Sensitivity Level (MSL) Rating |
|----------------------------|---|
| PAA110 / PAA110S / PAA110P | MSL 1 |

ESD Sensitivity



This product is **ESD Sensitive**, and should be handled according to the industry standard **JESD-625**.

Reflow Profile

This product has a maximum body temperature and time rating as shown below. All other guidelines of **J-STD-020** must be observed.

| Device | Maximum Temperature x Time |
|------------------|----------------------------|
| PAA110 / PAA110S | 250°C for 30 seconds |
| PAA110P | 260°C for 30 seconds |

Board Wash

IXYS Integrated Circuits Division recommends the use of no-clean flux formulations. However, board washing to remove flux residue is acceptable. Since IXYS Integrated Circuits Division employs the use of silicone coating as an optical waveguide in many of its optically isolated products, the use of a short drying bake could be necessary if a wash is used after solder reflow processes. Chlorine- or Fluorine-based solvents or fluxes should not be used. Cleaning methods that employ ultrasonic energy should not be used.



Mechanical Dimensions

PAA110

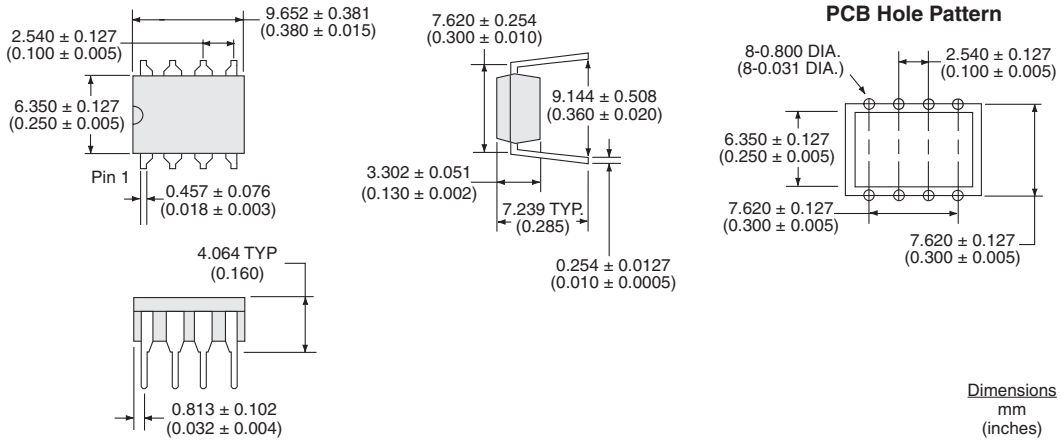

PAA110S

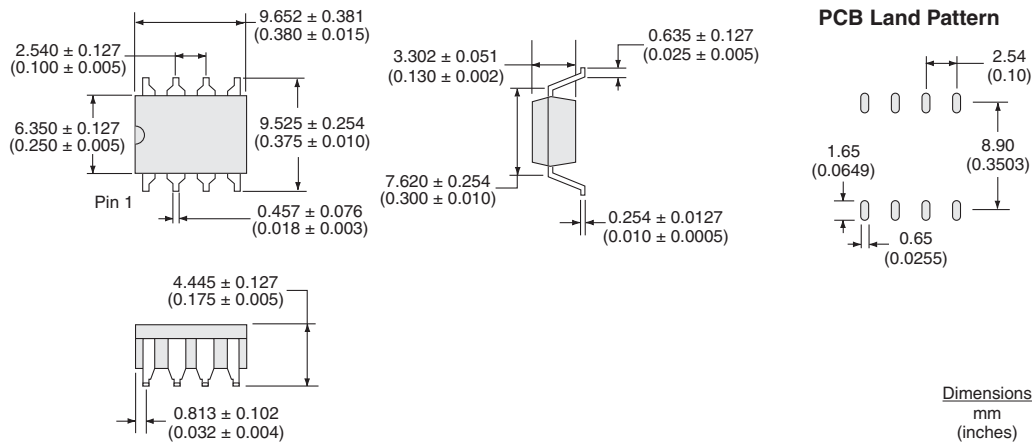

PAA110P

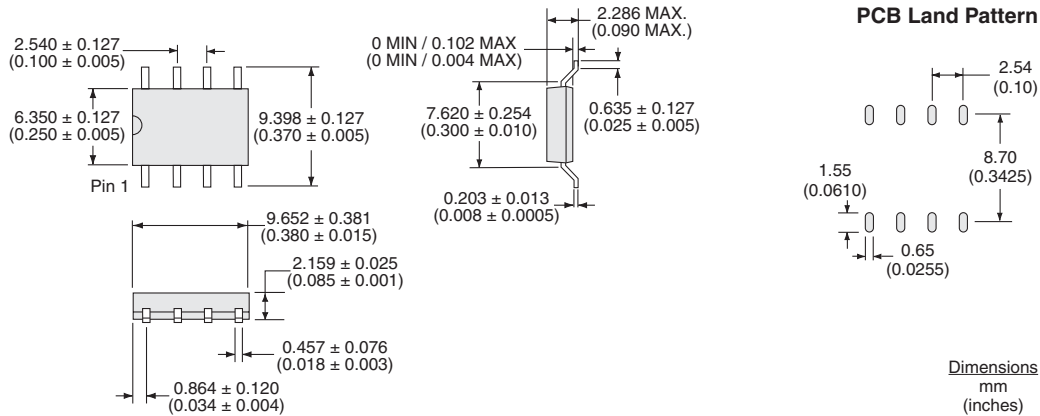

PAA110PTR Tape & Reel

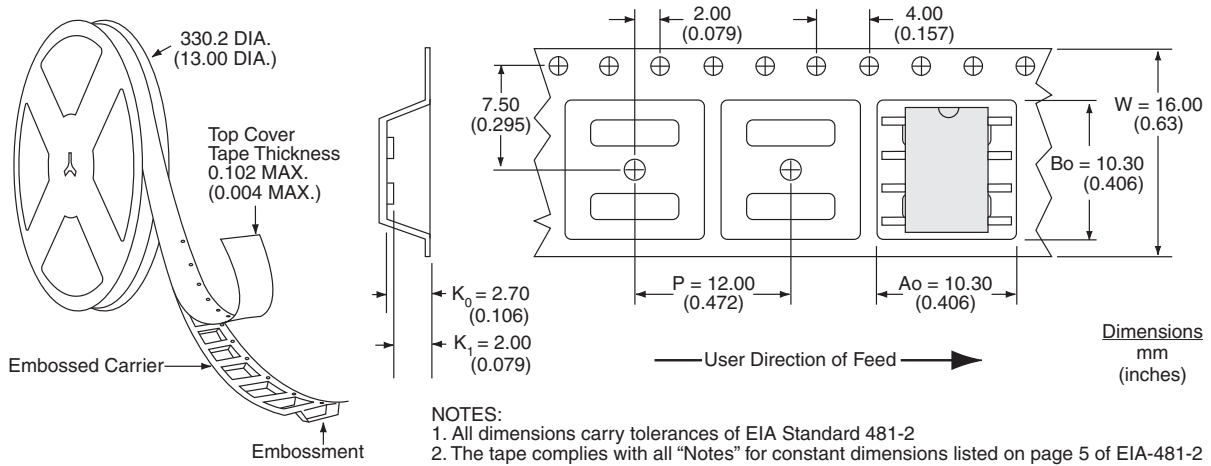

PAA110STR Tape & Reel

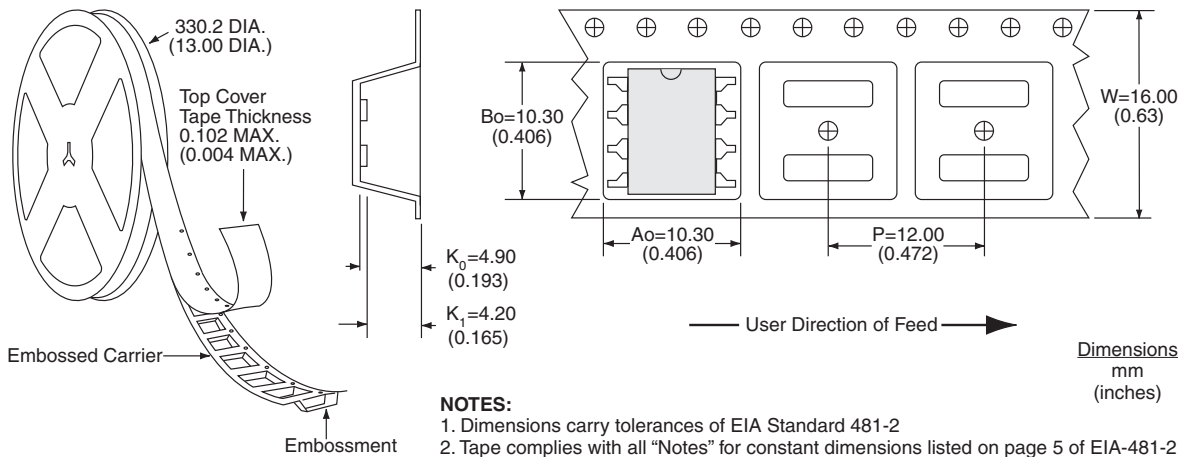

For additional information please visit our website at: www.ixysic.com

IXYS Integrated Circuits Division makes no representations or warranties with respect to the accuracy or completeness of the contents of this publication and reserves the right to make changes to specifications and product descriptions at any time without notice. Neither circuit patent licenses nor indemnity are expressed or implied. Except as set forth in IXYS Integrated Circuits Division's Standard Terms and Conditions of Sale, IXYS Integrated Circuits Division assumes no liability whatsoever, and disclaims any express or implied warranty, relating to its products including, but not limited to, the implied warranty of merchantability, fitness for a particular purpose, or infringement of any intellectual property right.

The products described in this document are not designed, intended, authorized or warranted for use as components in systems intended for surgical implant into the body, or in other applications intended to support or sustain life, or where malfunction of IXYS Integrated Circuits Division's product may result in direct physical harm, injury, or death to a person or severe property or environmental damage. IXYS Integrated Circuits Division reserves the right to discontinue or make changes to its products at any time without notice.

Компания «Life Electronics» занимается поставками электронных компонентов импортного и отечественного производства от производителей и со складов крупных дистрибьюторов Европы, Америки и Азии.

С конца 2013 года компания активно расширяет линейку поставок компонентов по направлению коаксиальный кабель, кварцевые генераторы и конденсаторы (керамические, пленочные, электролитические), за счёт заключения дистрибьюторских договоров

Мы предлагаем:

- Конкурентоспособные цены и скидки постоянным клиентам.
- Специальные условия для постоянных клиентов.
- Подбор аналогов.
- Поставку компонентов в любых объемах, удовлетворяющих вашим потребностям.
- Приемлемые сроки поставки, возможна ускоренная поставка.
- Доставку товара в любую точку России и стран СНГ.
- Комплексную поставку.
- Работу по проектам и поставку образцов.
- Формирование склада под заказчика.
- Сертификаты соответствия на поставляемую продукцию (по желанию клиента).
- Тестирование поставляемой продукции.
- Поставку компонентов, требующих военную и космическую приемку.
- Входной контроль качества.
- Наличие сертификата ISO.

В составе нашей компании организован Конструкторский отдел, призванный помогать разработчикам, и инженерам.

Конструкторский отдел помогает осуществить:

- Регистрацию проекта у производителя компонентов.
- Техническую поддержку проекта.
- Защиту от снятия компонента с производства.
- Оценку стоимости проекта по компонентам.
- Изготовление тестовой платы монтаж и пусконаладочные работы.



Тел: +7 (812) 336 43 04 (многоканальный)
Email: org@lifeelectronics.ru