

MAX44211

General Description

The MAX44211 is a low-distortion line driver customized for powerline communication (PLC) applications where high output current is needed to drive the isolation and coupling transformer under varying load conditions. The MAX44211 can be switched to implement all world standards, trading off improved linearity for increased quiescent current. The MAX44211 delivers a high 1.5A linear output current and provides peak-to-peak differential voltage swing of up to 36V. The MAX44211 features very low intermodulation and harmonic distortion ensuring they meet worldwide PLC standards.

The MAX44211 features advanced diagnostics for temperature and output current monitoring. There are high temperature warning and over temperature shutdown functions. There is also a programmable current limit. The status of these diagnostics are indicated via two open-drain status outputs.

The MAX44211 is designed to interface to powerlines that have wide ranging and variable loads and drive signals within the 9kHz to 500kHz frequency band. This device operates from a single supply and is available in a 4mm x 4mm, 20-pin TQFN package.

The MAX44211 device is specified for operation from -40°C to $+85^{\circ}\text{C}$.

Applications

- Powerline Communications
- Smart Meters
- Lighting
- Solar

Ordering Information appears at end of data sheet.

High-Current Differential Line Driver for Powerline Communications

Benefits and Features

- Meets Stringent ARIB, FCC, and CENELEC Linearity Specifications for Out-of-Band Emissions
 - Output Drives Current Linearly Up to 1.5A Peak Into a Reactive Load for PLC Applications
- Output Voltage Swings to Within 0.5V of AVDD or AGND (36V_{P-P} Differential) for Widest Dynamic Range
- Wide Power-Supply Range Addresses Multiple Standards:
 - +8V to +20V for Analog Supply
 - +2.7V to +5.5V for Digital Supply
- Programmable Output Current Limit via External Resistor Provides Flexibility
- Programmable Gain (6x, 12x, 15x, or 18x) via Gain Inputs Provides Multistandard Usage
- Status Logic Outputs Provide Improved Diagnostics
 - Overtemperature Shutdown Active
 - High-Temperature Warning Active
 - Overcurrent Active
 - Normal Operation

Functional Diagram

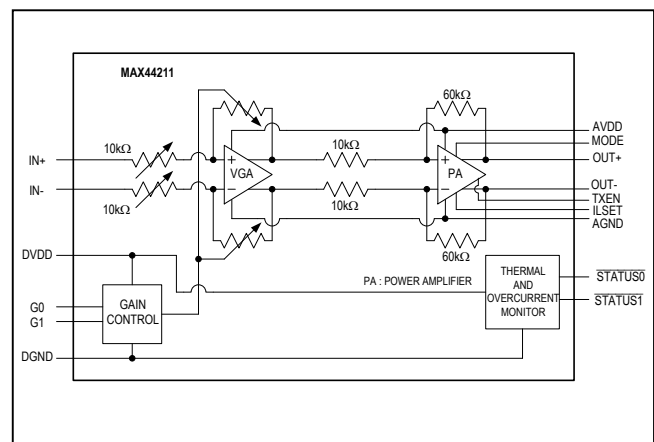

Absolute Maximum Ratings

AVDD to AGND-0.3V to +22V
 DVDD to DGND.....-0.3V to +6V
 DGND to AGND.....-0.3V to +0.3V
 IN+, IN-, OUT+, OUT- to AGND -0.3V to (V_{AVDD} + 0.3V)
 STATUS1, STATUS0, G1, G0,
 TXEN, MODE, ILSET to DGND-0.3V to (V_{DVDD} + 0.3V)
 Continuous Current into All Pins±20mA

Continuous Power Dissipation (T_A = +70°C)
 TQFN (Four-Layer Board)
 (derate 33.3mW/°C above +70°C)2666.7mW
 TQFN (Single Layer)
 (derate 20.8mW/°C above +70°C) 1666.7mW
 Operating Temperature Range..... -40°C to +85°C
 Junction Temperature..... +150°C
 Storage Temperature Range-65°C to +150°C
 Lead Temperature (soldering, 10s) +300°C
 Soldering Temperature (reflow) +260°C

Package Thermal Characteristics (Note 1)

TQFN Multilayer Board
 Junction-to-Ambient Thermal Resistance (θ_{JA})33°C/W
 Junction-to-Case Thermal Resistance (θ_{JC}).....2°C/W

TQFN Single-Layer Board
 Junction-to-Ambient Thermal Resistance (θ_{JA})48°C/W
 Junction-to-Case Thermal Resistance (θ_{JC}).....2°C/W

Note 1: Package thermal resistances were obtained using the method described in JEDEC specification JESD51-7, using a four-layer board. For detailed information on package thermal considerations, refer to www.maximintegrated.com/thermal-tutorial.

Stresses beyond those listed under "Absolute Maximum Ratings" may cause permanent damage to the device. These are stress ratings only, and functional operation of the device at these or any other conditions beyond those indicated in the operational sections of the specifications is not implied. Exposure to absolute maximum rating conditions for extended periods may affect device reliability.

Electrical Characteristics

(V_{DVDD} = 3V, V_{AVDD} = 12V or 18V, V_{AGND} = V_{DGND} = 0V, V_{IN+} = V_{IN-} = V_{AVDD}/2, G0 = V_{DVDD}, G1 = V_{DVDD}, TXEN = V_{DVDD}, MODE = V_{DVDD}, R_{SET} = 29kΩ, R_{LOAD} = 50Ω differential from OUT+ to OUT-, T_A = -40°C to +85°C, unless otherwise noted. Typical values are at T_A = +25°C.) (Note 2)

PARAMETER	SYMBOL	CONDITIONS		MIN	TYP	MAX	UNITS
POWER SUPPLY							
Analog Supply Voltage Range	V _{AVDD}			8		20	V
Digital Supply Voltage Range	V _{DVDD}			2.7		5.5	V
Quiescent Current	I _{AVDD}	V _{AVDD} = 12V	MODE Low, TXEN High	T _A = +25°C	22	28	mA
					30		
			MODE Low, TXEN Low	T _A = +25°C	1.9	3	
					3.5		
				41	50		
				55			
		MODE High, TXEN Low	T _A = +25°C	2	3		
				3.5			
	V _{AVDD} = 18V	MODE Low, TXEN High	T _A = +25°C	22	28		
			30				
MODE Low, TXEN Low		T _A = +25°C	2.1	3.0			
			3.5				
		43	50				
		55					
MODE High, TXEN Low	T _A = +25°C	2.3	3.0				
		3.5					

Electrical Characteristics (continued)

($V_{DVDD} = 3V$, $V_{AVDD} = 12V$ or $18V$, $V_{AGND} = V_{DGND} = 0V$, $V_{IN+} = V_{IN-} = V_{AVDD}/2$, $G0 = V_{DVDD}$, $G1 = V_{DVDD}$, $TXEN = V_{DVDD}$, $MODE = V_{DVDD}$, $R_{SET} = 29k\Omega$, $R_{LOAD} = 50\Omega$ differential from $OUT+$ to $OUT-$, $T_A = -40^\circ C$ to $+85^\circ C$, unless otherwise noted. Typical values are at $T_A = +25^\circ C$.) (Note 2)

PARAMETER	SYMBOL	CONDITIONS	MIN	TYP	MAX	UNITS	
Quiescent Current DVDD	I_{DVDD}		$T_A = +25^\circ C$		28	130	μA
						170	
Enable Time	t_{ENABLE}	From TXEN transition, low to high		2.4		μs	
Disable Time	t_{DIS}	From TXEN transition, high to low		60		μs	
INPUT							
Input Common-Mode Voltage		External AC coupled, internal bias level		$V_{AVDD}/2$		V	
Input Resistance	R_{IN}	$G1 = 0, G0 = 0, \text{Gain} = 6V/V$		20		k Ω	
		$G1 = 0, G0 = 1, \text{Gain} = 12V/V$		13.3			
		$G1 = 1, G0 = 0, \text{Gain} = 15V/V$		11.4			
		$G1 = 1, G0 = 1, \text{Gain} = 18V/V$		10			
Input Capacitance	C_{IN}			1		pF	
GAIN AND FREQUENCY RESPONSE							
Gain Accuracy			-2		+2	%	
Gain Error Drift				± 20		ppm/ $^\circ C$	
Output Slew Rate	SR	10V output step		80		V/ μs	
Full-Power Bandwidth	BW_{FP}	$V_{OUTDIFF} = 120dB\mu V, \text{Gain} = 18$		3.9		MHz	
		$V_{OUTDIFF} = 120dB\mu V, \text{Gain} = 6V/V$		8.5			
AC PSRR		$f = 50kHz, V_{AVDD}/(OUT+ - OUT-)$		20		dB	
LINEARITY							
In-Band/Out-of-Band Intermodulation Products (MODE Low)		$f_{IN1} = 50kHz, f_{IN2} = 55kHz,$ $V_{LOAD} = 125.6dB\mu VRMS$ (Note 4)		51		dB μV	
In-Band/Out-of-Band Intermodulation Products (MODE High)		$f_{IN1} = 200kHz, f_{IN2} = 250kHz,$ $V_{LOAD} = 125.6dB\mu VRMS,$ $R_{LOADDIFF} = 50\Omega$		51		dB μV	
OUTPUT							
Output Voltage High		Output saturated	$I_{SOURCE} = 1.5A$		$V_{AVDD} - 1.8$	V	
			$I_{SOURCE} = 300mA$		$V_{AVDD} - 0.5$		
Output Voltage Low		Output saturated	$I_{SINK} = 1.5A$		+1.8	V	
			$I_{SINK} = 300mA$		+0.5		
Drive Capability		$V_{AVDD} = 12V, R_{LOAD} = 2\Omega$ differential		125.6		dB $\mu VRMS$	

Electrical Characteristics (continued)

($V_{DVDD} = 3V$, $V_{AVDD} = 12V$ or $18V$, $V_{AGND} = V_{DGND} = 0V$, $V_{IN+} = V_{IN-} = V_{AVDD}/2$, $G0 = V_{DVDD}$, $G1 = V_{DVDD}$, $TXEN = V_{DVDD}$, $MODE = V_{DVDD}$, $R_{SET} = 29k\Omega$, $R_{LOAD} = 50\Omega$ differential from $OUT+$ to $OUT-$, $T_A = -40^\circ C$ to $+85^\circ C$, unless otherwise noted. Typical values are at $T_A = +25^\circ C$.) (Note 2)

PARAMETER	SYMBOL	CONDITIONS		MIN	TYP	MAX	UNITS
Output Impedance	Z_O	Single ended	$TXEN = 1$, $f_C = 100kHz$		500		m Ω
			$TXEN = 0$		35		k Ω
Gain		$G1 = 0$, $G0 = 0$			6		V/V
		$G1 = 0$, $G0 = 1$			12		
		$G1 = 1$, $G0 = 0$			15		
		$G1 = 1$, $G0 = 1$			18		
Input Noise-Voltage Density	e_n	$f = 100kHz$, $G1 = 0$, $G0 = 0$, differential output			120		nV/ \sqrt{Hz}
PROTECTION							
Overtemperature Shutdown Threshold	T_{OVTS}				+160		$^\circ C$
Overtemperature Shutdown Threshold Hysteresis					15		$^\circ C$
Overtemperature Warning Threshold	T_{OVTW}				+150		$^\circ C$
Output Current Limit	I_{LIM}	$R_{RSET} = 29k\Omega$			2		A
DIGITAL INPUT CHARACTERISTICS (G1, G0, TXEN, MODE)							
Input Voltage Range				0		V_{DVDD}	V
Input Voltage High	V_{IH}			$0.7 \times V_{DVDD}$			V
Input Voltage Low	V_{IL}				$0.3 \times V_{DVDD}$		V
Input Capacitance	C_{IN}				10		pF
Input Hysteresis Voltage	V_{HYS}				0.15		V
DIGITAL OUTPUT CHARACTERISTICS (STATUS1, STATUS0)							
Output Voltage Low (Active)	V_{ST}	$I_{SINK} = 3mA$				0.4	V
Output Leakage (Inactive)	I_{STZ}				± 0.1	± 1	μA
Output Capacitance (Inactive)	C_{STZ}				10		pF

Note 2: Min/max values are 100% production tested at $T_A = +25^\circ C$. Specifications over temperature are guaranteed by design.

Note 3: Linearity specification limits are quasi-peak.

Note 4: The device is loaded with the network shown in Figure 3 and Figure 4.

Note 5: The device is driven with a typical CENELEC OFDM signal.

Note 6: The device is driven with a typical ARIB OFDM signal. It is loaded with the network shown in Figure 5. Signals are measured at the measurement port but calculated as signals over the entire resistive load.

Note 7: External DC blocking capacitors are required.

Note 8: Measured with 200Hz bandwidth up to 150kHz and 9kHz bandwidth above 150kHz as specified in EN50065-1:2011.

Typical Operating Characteristics

($V_{DVDD} = 3V$, $V_{AVDD} = 12V$ or $18V$, $V_{AGND} = V_{DGND} = 0V$, $IN+ = IN- = V_{AVDD}/2$, $G0 = V_{DVDD}$, $G1 = V_{DVDD}$, $T_{XEN} = V_{DVDD}$, $MODE = V_{DVDD}$, $R_{SET} = 29k\Omega$, $R_{LOAD} = 50\Omega$ differential from $OUT+$ to $OUT-$, $T_A = +25^\circ C$, unless otherwise noted. Typical values are at $T_A = +25^\circ C$.)

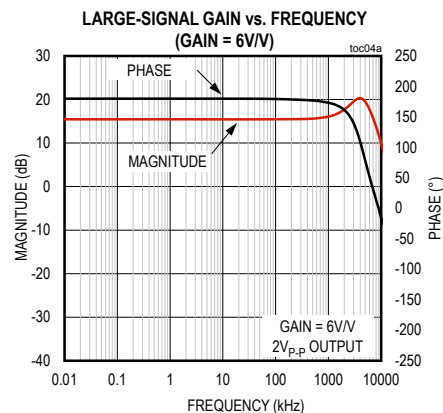
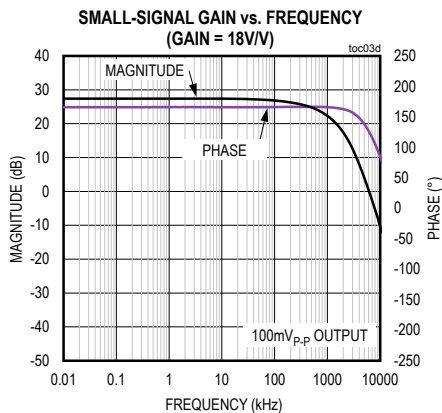
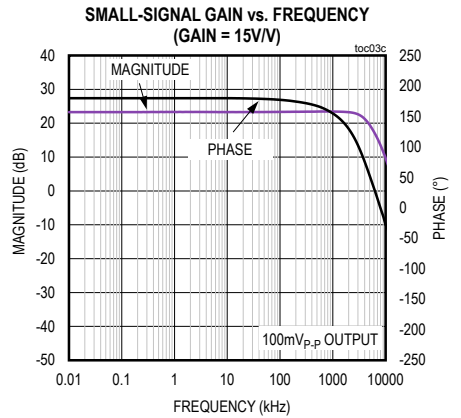
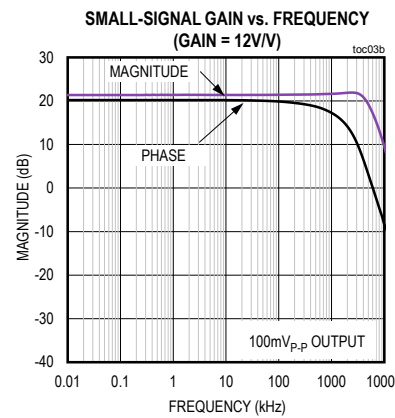
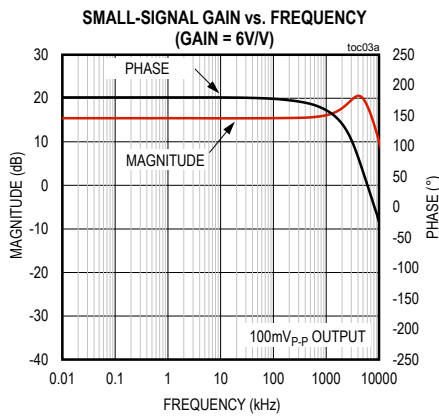
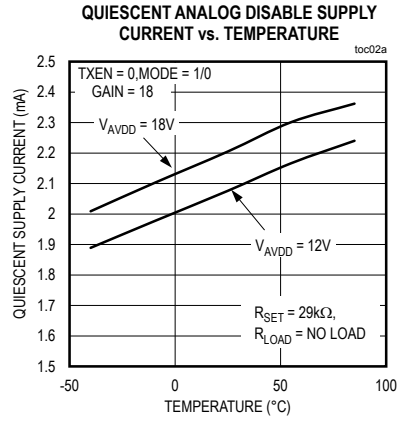
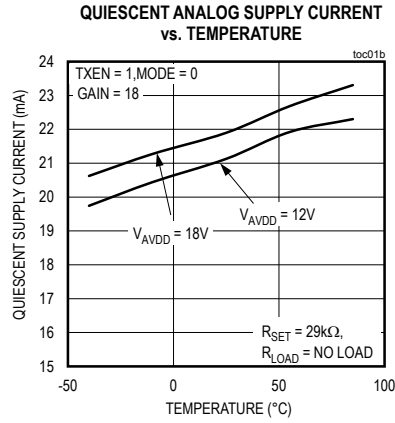
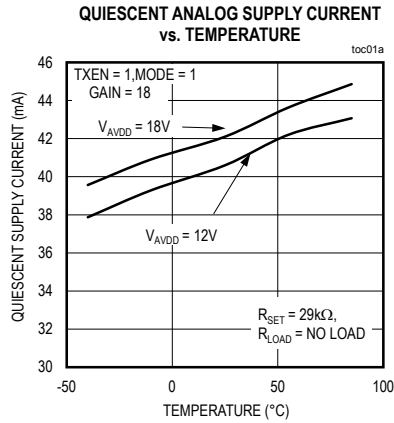

Typical Operating Characteristics (continued)

($V_{DVDD} = 3V$, $V_{AVDD} = 12V$ or $18V$, $V_{AGND} = V_{DGND} = 0V$, $IN+ = IN- = V_{AVDD}/2$, $G0 = V_{DVDD}$, $G1 = V_{DVDD}$, $T_{XEN} = V_{DVDD}$, $MODE = V_{DVDD}$, $R_{SET} = 29k\Omega$, $R_{LOAD} = 50\Omega$ differential from $OUT+$ to $OUT-$, $T_A = +25^\circ C$, unless otherwise noted. Typical values are at $T_A = +25^\circ C$.)

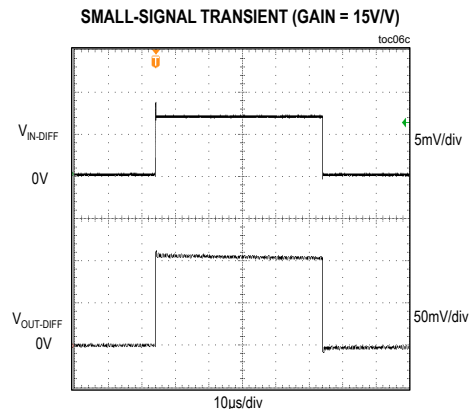
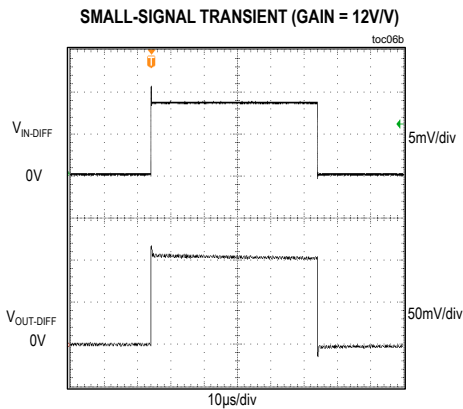
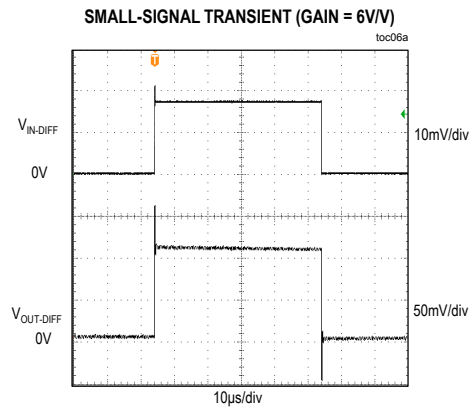
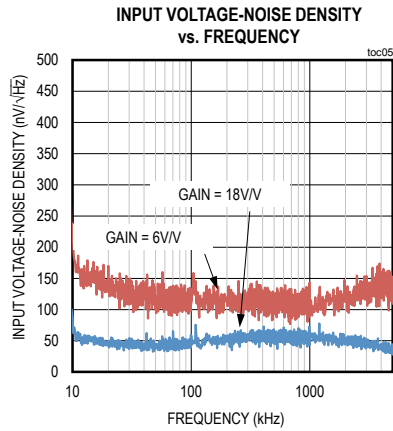
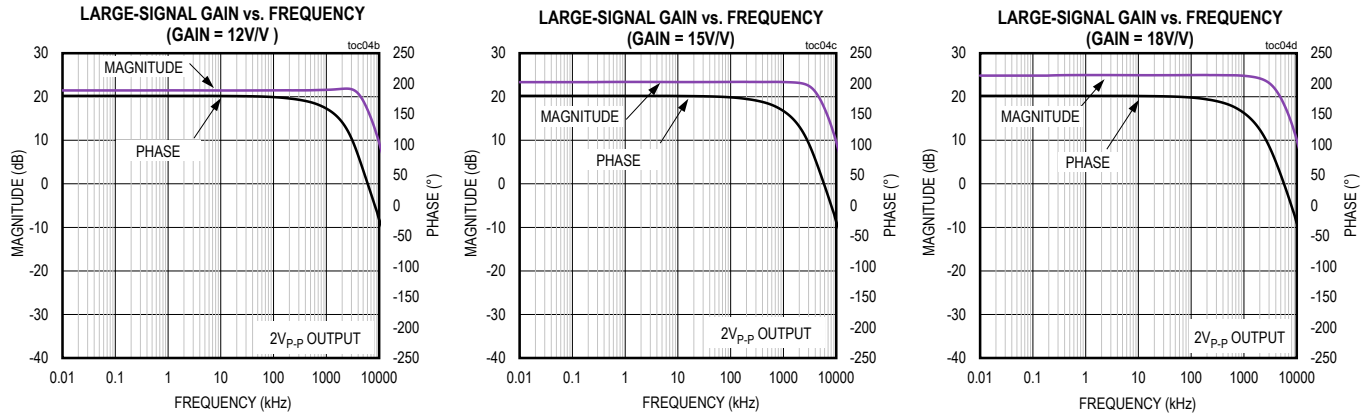

Typical Operating Characteristics (continued)

($V_{DVDD} = 3V$, $V_{AVDD} = 12V$ or $18V$, $V_{AGND} = V_{DGND} = 0V$, $IN+ = IN- = V_{AVDD}/2$, $G0 = V_{DVDD}$, $G1 = V_{DVDD}$, $T_{XEN} = V_{DVDD}$, $MODE = V_{DVDD}$, $R_{SET} = 29k\Omega$, $R_{LOAD} = 50\Omega$ differential from $OUT+$ to $OUT-$, $T_A = +25^\circ C$, unless otherwise noted. Typical values are at $T_A = +25^\circ C$.)

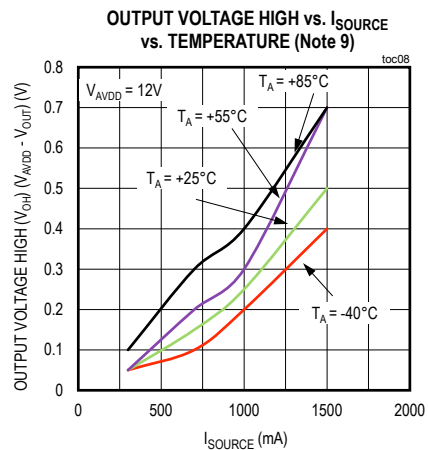
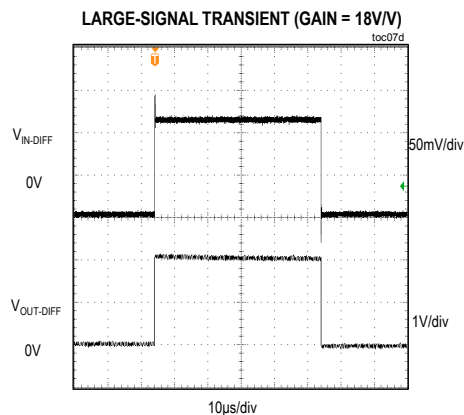
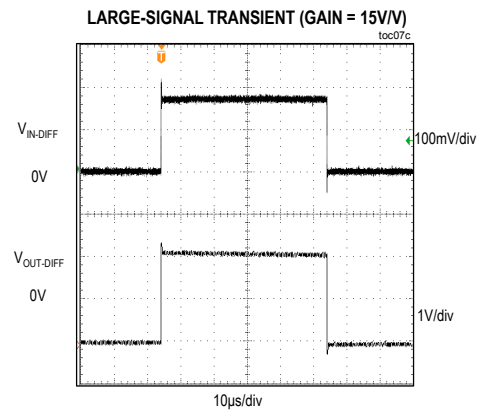
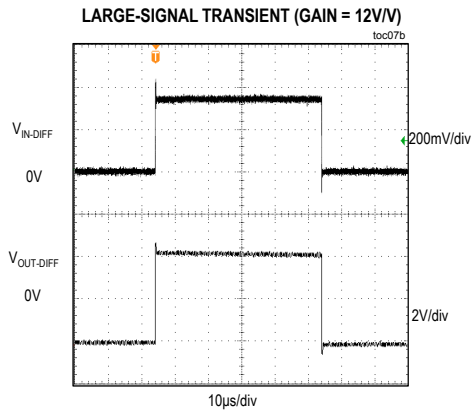
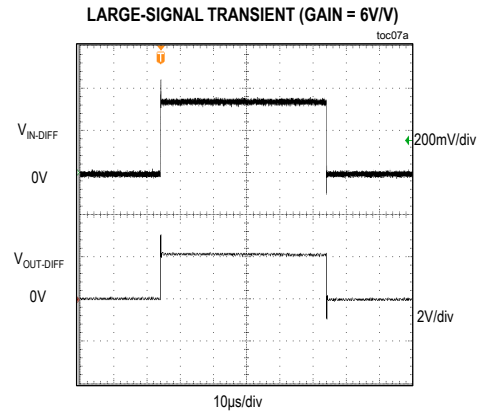
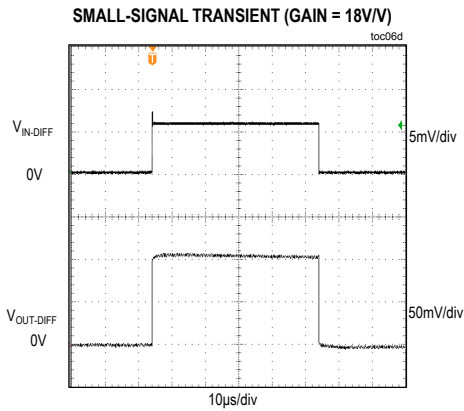

Typical Operating Characteristics (continued)

($V_{DVDD} = 3V$, $V_{AVDD} = 12V$ or $18V$, $V_{AGND} = V_{DGND} = 0V$, $IN+ = IN- = V_{AVDD}/2$, $G0 = V_{DVDD}$, $G1 = V_{DVDD}$, $T_{XEN} = V_{DVDD}$, $MODE = V_{DVDD}$, $R_{SET} = 29k\Omega$, $R_{LOAD} = 50\Omega$ differential from $OUT+$ to $OUT-$, $T_A = +25^\circ C$, unless otherwise noted. Typical values are at $T_A = +25^\circ C$.)

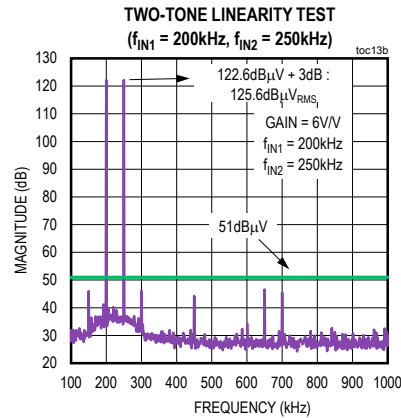
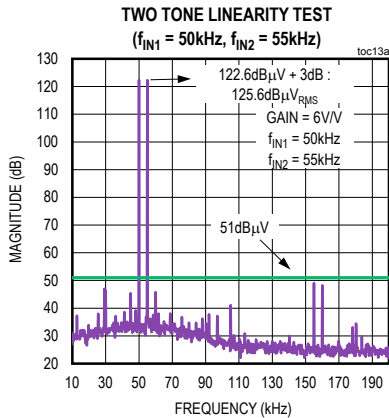
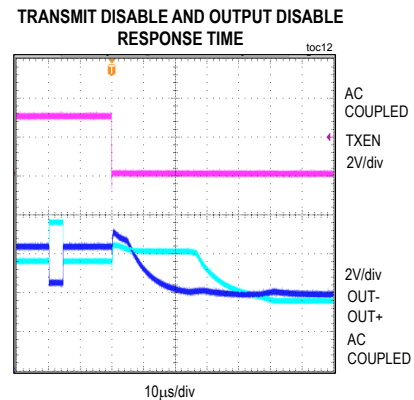
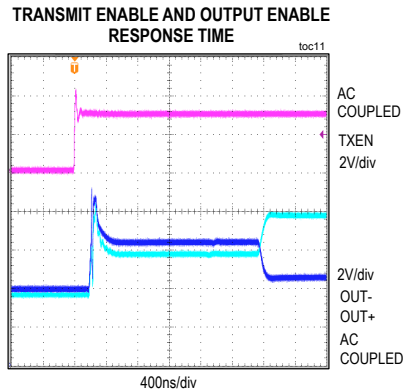
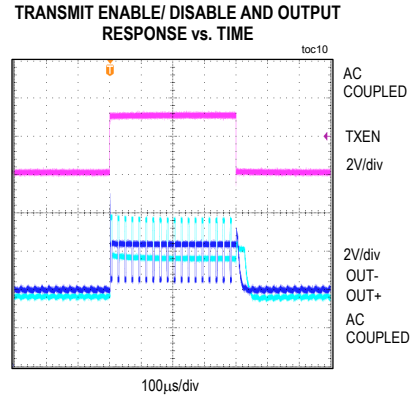
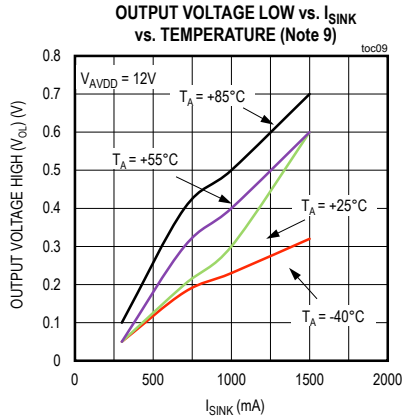

Note 9: Output voltage high and output voltage low tests were performed by providing an AC input pulse with 1% duty cycle to saturate the outputs and obtain the results.

Pin Configuration

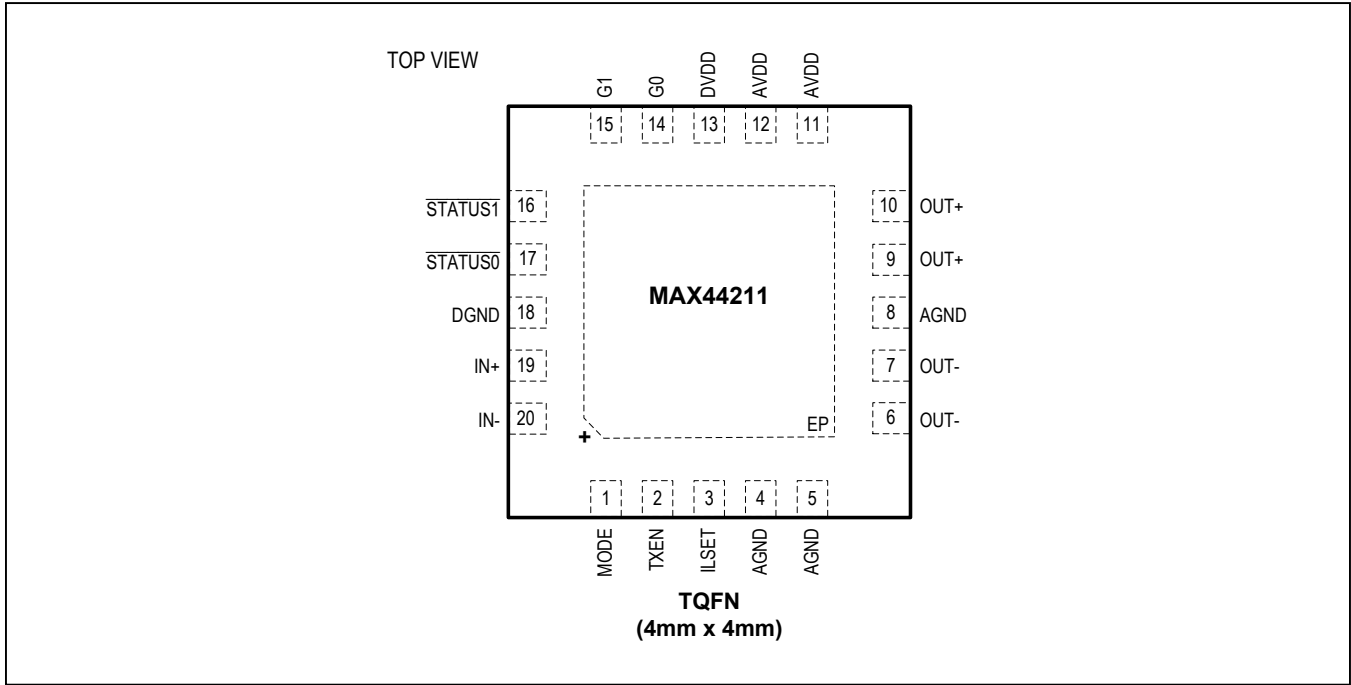

Pin Description

PIN	NAME	FUNCTION
1	MODE	MODE Input. Leave MODE input unconnected to select low quiescent current mode to support CENELEC applications. Pull MODE input high to select higher quiescent current mode to support FCC and ARIB applications. See the <i>Bias Selection</i> section for more details.
2	TXEN	Transmit Enable. Pull TXEN high to enable the amplifier outputs. Tie TXEN to DGND to disable the amplifier outputs. See the <i>Output Enable</i> section.
3	ILSET	Current-Limit Setting Input. Connect a resistor between ILSET and AGND to set the current limit for the outputs. See the <i>Protection and Diagnostics</i> section.
4, 5, 8	AGND	Analog Ground
6, 7	OUT-	Negative Signal Output
9, 10	OUT+	Positive Signal Output
11, 12	AVDD	Amplifier Analog Power Supply. Bias AVDD to AGND between 8V to 20V.
13	DVDD	Digital Power Supply. Bias DVDD to DGND between 2.7V to 5.5V.
14	G0	Variable Gain Amplifier Gain Select Input 0. See Table 1 for details.
15	G1	Variable Gain Amplifier Gain Select Input 1. See Table 1 for details.

Pin Description (continued)

PIN	NAME	FUNCTION
16	STATUS1	Open-Drain Active-Low Status Output1. See Table 2 for details.
17	STATUS0	Open-Drain Active-Low Status Output0. See Table 2 for details.
18	DGND	Digital Ground
19	IN+	Positive Signal Input
20	IN-	Negative Signal Input
—	EP	Exposed Pad. Internally connected to AGND. Connect the EP to a copper plane to enhance thermal dissipation.

Detailed Description

A common technique used to couple OFDM signals to the AC powerline is through a signal transformer. A line driver is needed to provide adequate levels of current and voltage to drive the varying loads that exist on today's powerlines.

The MAX44211 line driver is efficient low-distortion power amplifiers that drive high current to the low-impedance loads common in powerline communication (PLC) applications. The output stage is designed to linearly drive up to 1.5A peak current and a differential voltage of up to 36V_{P-P}. They feature very intermodulation distortion to meet the demanding requirements of today's standards.

The MAX44211 also features two open-drain diagnostic outputs, STATUS1 and STATUS0. These act as flags to indicate the status of the part. Another significant feature of the MAX44211 is its thermal monitoring and shutdown capability. This allows the device to alert the host microcontroller of high temperature situations and then to automatically shut down to prevent damage should the temperature rise further.

Output Enable

Enable the MAX44211 output by pulling TXEN high. The amplifier outputs are fully enabled 2.4μs (typ) after TXEN is pulled high. If a signal is applied to the IN+ and IN- inputs during the startup time, it may be distorted and the linearity specifications may not be met.

Bias MODE Selection

The MAX44211 linearity can be improved at the expense of quiescent current. To meet CENELEC linearity requirements and save power, the MODE input is left unconnected. To improve linearity and meet ARIB or FCC requirements, the MODE input is pulled high.

Gain Selection and Output Connection

Set the MAX44211 overall gain using the G1 and G0 inputs (Table 1). The outputs, OUT+ and OUT- are internally biased at V_{AVDD}/2 to allow for maximum voltage swing. Therefore, the output should be A.C. coupled to the coupling transformer to avoid DC currents flowing in the transformer. In addition, the secondary side of the transformer should also be AC-coupled to avoid shorting the line input.

Protection and Diagnostics

The MAX44211 has two diagnostic status outputs: STATUS0 and STATUS1. These are open drain outputs that indicate the status of the device as shown in Table 2.

Both of the MAX44211 outputs are current limited. Set the output current limit according to the following equation.

$$I_{LIM} = \frac{60}{R_{SET} + 1}$$

While R_{SET} is in kΩ and I_{LIM} is in ampere (see *Typical Operating Circuit*).

Do not use R_{SET} values below 23kΩ or above 250kΩ. Note that the tolerance for the current limit is ±30% so care must be taken to ensure that the limit is set high enough to avoid clipping at peak loads. In addition, if the current limit is set too high, the device may enter thermal shutdown mode.

Table 1. Voltage Gain Selection

G1	G0	GAIN (V/V)
0	0	6
0	1	12
1	0	15
1	1	18

If the device tries to drive current in excess of the programmable, threshold, it will limit at the threshold level. This will be indicated by the $\overline{\text{STATUS1}}$ and $\overline{\text{STATUS0}}$ outputs as shown in Table 2. External protection for the line driver is required. Schottky diodes like B320A or B350A protect the outputs from the back EMF generated by the coupler/isolator connected to the AC mains. TVS diodes on the primary and the secondary side of the coupler help suppress the high-voltage transient spikes from the AC mains to the MAX44211 outputs.

Table 2. Diagnostic Status Line Definitions

$\overline{\text{STATUS1}}$	$\overline{\text{STATUS0}}$	DEVICE STATUS
0	0	Overtemperature Shutdown Active
0	1	High Temperature Warning Active
1	0	Overcurrent Active
1	1	Normal Operation

Temperature Protection

A typical PLC signal is shown in Figure 1 continuously driving a 2Ω load. During this condition, the internal die temperature of the MAX44211 will eventually go beyond 160°C and the part enters into shutdown due to overheating. Once the part shuts down, the internal die temperature cools down enough to reach the 15°C hysteresis within milliseconds and the part then comes out of shutdown. If the load remains 2Ω, similar conditions are seen and the process becomes cyclic. This internal temperature protection circuit regulates the temperature thereby avoiding a thermal breakdown of the MAX44211.

As shown in Figure 1, the input channel ((IN+) - (IN-)) depicts a typical PLC packet signal transmitted every 75ms. In the middle of the third packet transmission at about 175ms when driving a 125dBμV signal into a 2Ω load, the MAX44211 enters overtemperature shutdown for about 35ms. STAT0 and STAT1 go low and the outputs are disabled. After the internal die cools down by 15°C, the part turns on driving 125dBμV into 2Ω load enters into overtemperature warning immediately (STAT1: LOW and STAT0 : HIGH).

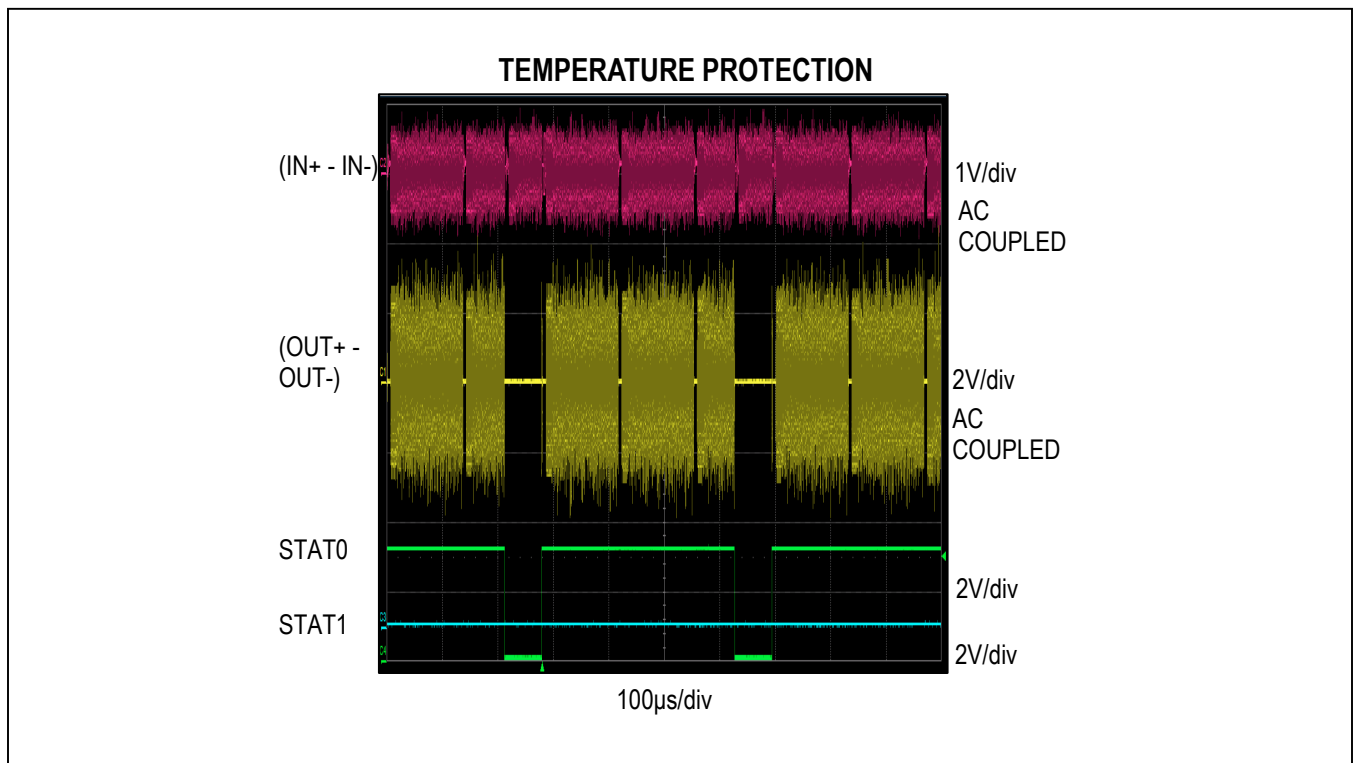

Figure 1. Temperature Protection

Thermal Design

In PLC applications, the driver is required to drive high currents into potentially low-impedance AC lines. These conditions cause instantaneous power dissipation of several watts, resulting in heating of the driver. Thermal heat flow can be modeled in a similar way to current flow in an electrical circuit. See [Figure 2](#).

Heat flows from the die through a thermal resistance, R_{JC} , to the case and through R_{CA} to the ambient outside world. These two thermal resistances are lumped together and specified as R_{JA} . In addition to these thermal resistances, there are thermal capacitances. Therefore, the die will take a certain time to heat since the thermal capacitances need to be “charged.” The die temperature is calculated using the following equation:

$$T_J = T_A + (R_{\theta JA} \times P_D)$$

If the device were to be mounted on a four-layer board with a large copper area and dissipate 3.5W at an ambient temperature of 85°C, the steady-state die temperature would be 200.5°C. This would obviously cause a problem. However, in the PLC application, the device is only required to be in transmit mode infrequently and for a small time. Therefore, since the thermal flow model is analogous to an electrical lowpass filter, the die temperature does not rise significantly.

It is recommended that the device be mounted on a four-layer board where the exposed heat paddle is soldered to the board. Further, it is recommended that as many via holes as possible are positioned in the pad to allow heat to be conducted through the PCB to a large heatsink area on the reverse side of the board.

If, however, the devices do overheat through some system fault, they have a diagnostic monitor to avoid damage. The device has two temperature thresholds: Warning (150°C) and Shutdown (160°C). If the warning threshold is crossed, the device will indicate this by pulling the `STATUS1` output low while keeping `STATUS0` output

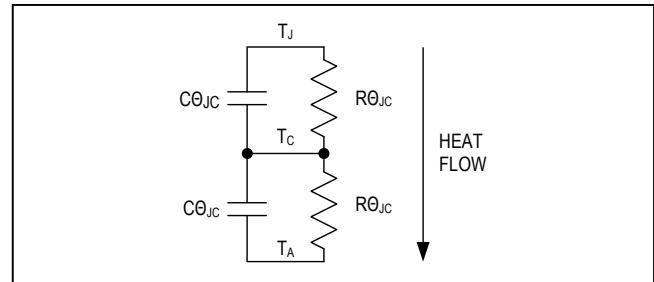

Figure 2. Thermal Flow Model

high. If the device heats further and crosses the shutdown threshold, both `STATUS_` outputs assert low and the device will automatically shut down and remain in that condition until it cools below 145°C (shutdown threshold–shutdown hysteresis). When in thermal shutdown mode, both power amplifier outputs (`OUT+`, `OUT-`) are shut down and in a high-impedance state.

Power Supplies

The MAX44211 operates from separate analog and digital power supplies. `DVDD` is the digital supply and should be connected to the same supply as the host processor. The logic thresholds for the digital input lines are `DVDD` related and therefore no level translators are required to interface between the host and the MAX44211. `DGND` should be connected back to the host power supply.

The analog section including the power amplifier operates from a single unipolar supply, `AVDD`. `AGND` should be connected back to the analog supply.

`AGND` and `DGND` should be connected together in a star formation for best noise performance.

The exposed pad, `EP`, is internally connected to `AGND` and should be connected to a large copper area for best heat dissipation.

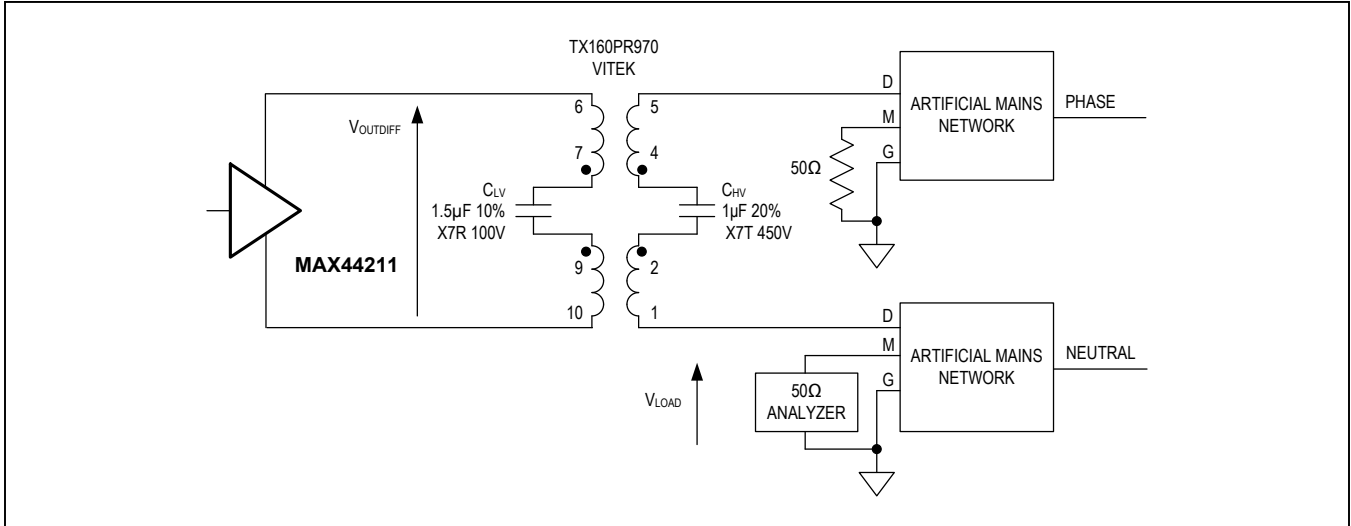

Figure 3. Test Structure for Cenelec

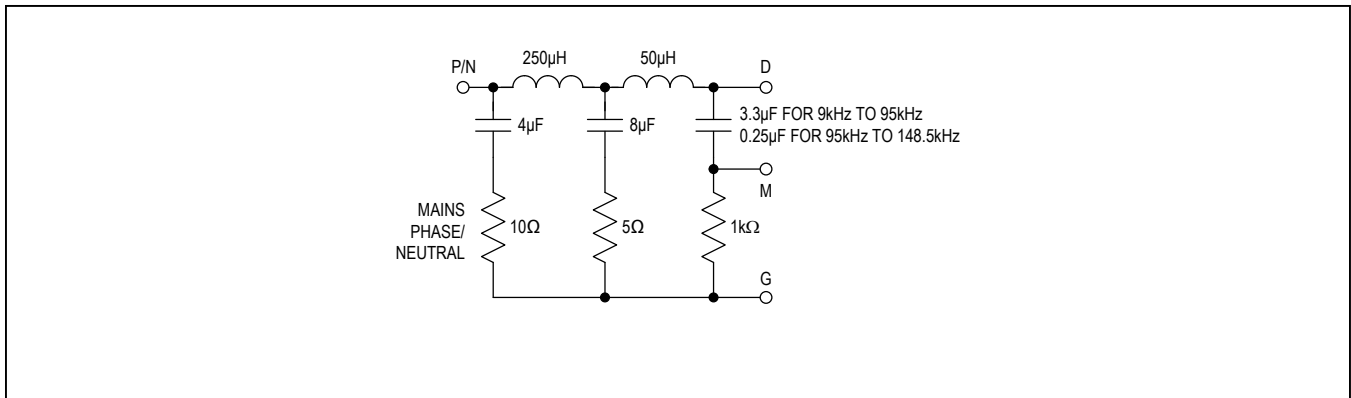

Figure 4. Artificial Mains Network

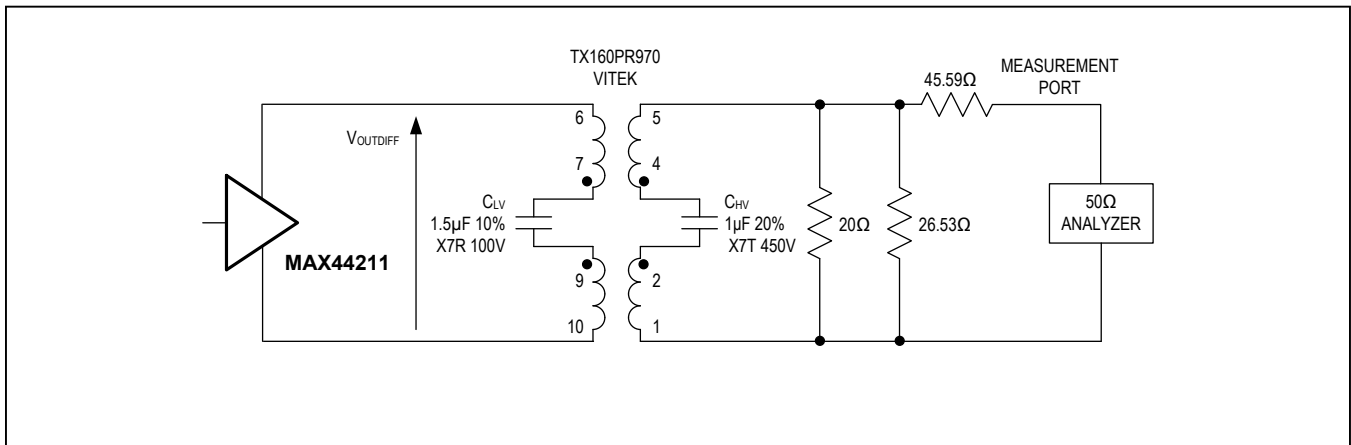

Figure 5. Test Structure for ARIB

Revision History

REVISION NUMBER	REVISION DATE	DESCRIPTION	PAGES CHANGED
0	6/15	Initial release	—

For pricing, delivery, and ordering information, please contact Maxim Direct at 1-888-629-4642, or visit Maxim Integrated's website at www.maximintegrated.com.

Maxim Integrated cannot assume responsibility for use of any circuitry other than circuitry entirely embodied in a Maxim Integrated product. No circuit patent licenses are implied. Maxim Integrated reserves the right to change the circuitry and specifications without notice at any time. The parametric values (min and max limits) shown in the Electrical Characteristics table are guaranteed. Other parametric values quoted in this data sheet are provided for guidance.

Компания «Life Electronics» занимается поставками электронных компонентов импортного и отечественного производства от производителей и со складов крупных дистрибьюторов Европы, Америки и Азии.

С конца 2013 года компания активно расширяет линейку поставок компонентов по направлению коаксиальный кабель, кварцевые генераторы и конденсаторы (керамические, пленочные, электролитические), за счёт заключения дистрибьюторских договоров

Мы предлагаем:

- Конкурентоспособные цены и скидки постоянным клиентам.
- Специальные условия для постоянных клиентов.
- Подбор аналогов.
- Поставку компонентов в любых объемах, удовлетворяющих вашим потребностям.
- Приемлемые сроки поставки, возможна ускоренная поставка.
- Доставку товара в любую точку России и стран СНГ.
- Комплексную поставку.
- Работу по проектам и поставку образцов.
- Формирование склада под заказчика.
- Сертификаты соответствия на поставляемую продукцию (по желанию клиента).
- Тестирование поставляемой продукции.
- Поставку компонентов, требующих военную и космическую приемку.
- Входной контроль качества.
- Наличие сертификата ISO.

В составе нашей компании организован Конструкторский отдел, призванный помогать разработчикам, и инженерам.

Конструкторский отдел помогает осуществить:

- Регистрацию проекта у производителя компонентов.
- Техническую поддержку проекта.
- Защиту от снятия компонента с производства.
- Оценку стоимости проекта по компонентам.
- Изготовление тестовой платы монтаж и пусконаладочные работы.



Тел: +7 (812) 336 43 04 (многоканальный)
Email: org@lifeelectronics.ru