

**High sensitivity, 50 mW  
Nominal operating power,  
2 Form C and 1 A relays**

# TX-S RELAYS

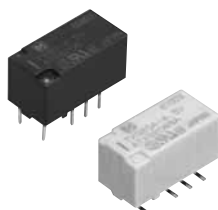

**RoHS compliant**

### FEATURES

- High sensitivity and Nominal operating power of 50mW**
- Compact size**  
15.0 (L) × 7.4 (W) × 8.2 (H) mm  
.591 (L) × .291 (W) × .323 (H) inch
- High contact reliability**  
High contact reliability is achieved by the use of gold-clad twin crossbar contacts, low-gas formation materials, mold sealing the coil section, and by controlling organic gas in the coil.  
**\*We also offer a range of products with AgPd contacts suitable for use in low level load analog circuits (Max. 10V DC 10 mA).**
- Outstanding surge resistance.**  
1,500 V 10×160 μsec. (FCC part 68) (open contacts)  
2,500 V 2×10 μsec. (Telcordia) (contact and coil)
- Low thermal electromotive force (approx. 0.3 μV)**

### TYPICAL APPLICATIONS

- Communications (XDSL, Transmission)
- Measurement
- Security
- Home appliances, and audio/visual equipment
- Medical equipment

### ORDERING INFORMATION

	TXS	2		-		-		-		-		-		-	
Contact arrangement		2													
Surface-mount availability															
Operating function															
Terminal shape															
Nominal coil voltage (DC)															
Contact material															
Packing style															

Nil: Standard PC board terminal type  
 SA: SA type  
 Nil: Single side stable  
 LT: 2 coil latching  
 Nil: Standard PC board terminal or surface-mount terminal  
 3, 4.5, 6, 9, 12, 24V  
 Nil: Standard contact (Ag+Au clad)  
 1: AgPd contact (low level load); AgPd+Au clad (stationary), AgPd (movable)  
 Nil: Tube packing  
 X: Tape and reel (picked from 1/3/4/5-pin side)  
 Z: Tape and reel packing (picked from the 8/9/10/12-pin side)

## TYPES

### 1. Standard PC board terminal

Contact arrangement	Nominal coil voltage	Single side stable		2 coil latching	
		Part No.		Part No.	
2 Form C	3 V DC	TXS2-3V		TXS2-LT-3V	
	4.5 V DC	TXS2-4.5V		TXS2-LT-4.5V	
	6 V DC	TXS2-6V		TXS2-LT-6V	
	9 V DC	TXS2-9V		TXS2-LT-9V	
	12 V DC	TXS2-12V		TXS2-LT-12V	
	24 V DC	TXS2-24V		TXS2-LT-24V	

Standard packing: Tube: 40 pcs.; Case: 1,000 pcs.

Note: Please add "-1" to the end of the part number for AgPd contacts (low level load).

### 2. Surface-mount terminal

#### 1) Tube packing

Contact arrangement	Nominal coil voltage	Single side stable		2 coil latching	
		Part No.		Part No.	
2 Form C	3 V DC	TXS2SA-3V		TXS2SA-LT-3V	
	4.5 V DC	TXS2SA-4.5V		TXS2SA-LT-4.5V	
	6 V DC	TXS2SA-6V		TXS2SA-LT-6V	
	9 V DC	TXS2SA-9V		TXS2SA-LT-9V	
	12 V DC	TXS2SA-12V		TXS2SA-LT-12V	
	24 V DC	TXS2SA-24V		TXS2SA-LT-24V	

Standard packing: Tube: 40 pcs.; Case: 1,000 pcs.

Note: Please add "-1" to the end of the part number for AgPd contacts (low level load).

#### 2) Tape and reel packing

Contact arrangement	Nominal coil voltage	Single side stable		2 coil latching	
		Part No.		Part No.	
2 Form C	3 V DC	TXS2SA-3V-Z		TXS2SA-LT-3V-Z	
	4.5 V DC	TXS2SA-4.5V-Z		TXS2SA-LT-4.5V-Z	
	6 V DC	TXS2SA-6V-Z		TXS2SA-LT-6V-Z	
	9 V DC	TXS2SA-9V-Z		TXS2SA-LT-9V-Z	
	12 V DC	TXS2SA-12V-Z		TXS2SA-LT-12V-Z	
	24 V DC	TXS2SA-24V-Z		TXS2SA-LT-24V-Z	

Standard packing: Tape and reel: 500 pcs.; Case: 1,000 pcs.

Notes: 1. Tape and reel packing symbol "-Z" is not marked on the relay. "X" type tape and reel packing (picked from 1/2/3/4-pin side) is also available.

2. Please add "-1" to the end of the part number for AgPd contacts (low level load). (Ex. TXS2SA-3V-1-Z)

## RATING

### 1. Coil data

#### 1) Single side stable

Nominal coil voltage	Pick-up voltage (at 20°C 68°F)	Drop-out voltage (at 20°C 68°F)	Nominal operating current [±10%] (at 20°C 68°F)		Coil resistance [±10%] (at 20°C 68°F)		Nominal operating power	Max. applied voltage (at 20°C 68°F)
3 V DC	80%V or less of nominal voltage* (Initial)	10%V or more of nominal voltage* (Initial)	16.7 mA		180 Ω		50 mW	150%V of nominal voltage
4.5 V DC			11.1 mA		405 Ω			
6 V DC			8.3 mA		720 Ω			
9 V DC			5.6 mA		1,620 Ω			
12 V DC			4.2 mA		2,880 Ω			
24 V DC			2.9 mA		8,229 Ω		70 mW	

#### 2) 2 coil latching

Nominal coil voltage	Set voltage (at 20°C 68°F)	Reset voltage (at 20°C 68°F)	Nominal operating current [±10%] (at 20°C 68°F)		Coil resistance [±10%] (at 20°C 68°F)		Nominal operating power		Max. applied voltage (at 20°C 68°F)
			Set coil	Reset coil	Set coil	Reset coil	Set coil	Reset coil	
3 V DC	80%V or less of nominal voltage* (Initial)	80%V or less of nominal voltage* (Initial)	23.3 mA	23.3 mA	129 Ω	129 Ω	70 mW	70 mW	150%V of nominal voltage
4.5 V DC			15.6 mA	15.6 mA	289 Ω	289 Ω			
6 V DC			11.7 mA	11.7 mA	514 Ω	514 Ω			
9 V DC			7.8 mA	7.8 mA	1,157 Ω	1,157 Ω			
12 V DC			5.8 mA	5.8 mA	2,057 Ω	2,057 Ω			
24 V DC			6.3 mA	6.3 mA	3,840 Ω	3,840 Ω	150 mW	150 mW	

\*Pulse drive (JIS C 5442-1986)

2. Specifications

Characteristics	Item	Specifications	
Contact	Arrangement	2 Form C	
	Initial contact resistance, max.	Max. 100 mΩ (By voltage drop 6 V DC 1A)	
	Contact material	Standard contact: Ag+Au clad, AgPd contact (low level load): AgPd+Au clad (stationary), AgPd (movable)	
Rating	Nominal switching capacity	1 A 30 V DC (resistive load)	
	Max. switching power	30 W (DC) (resistive load)	
	Max. switching voltage	110V DC	
	Max. switching current	1 A	
	Min. switching capacity (Reference value)*1	10μA 10mV DC	
	Nominal operating power	Single side stable 50 mW (3 to 12 V DC), 70 mW (24 V DC) 2 coil latching 70 mW (3 to 12 V DC), 150 mW (24 V DC)	
Electrical characteristics	Insulation resistance (Initial)	Min. 1,000MΩ (at 500V DC) Measurement at same location as "Initial breakdown voltage" section.	
	Breakdown voltage (Initial)	Between open contacts	750 Vrms for 1min. (Detection current: 10mA)
		Between contact and coil	1,800 Vrms for 1min. (Detection current: 10mA)
		Between contact sets	1,000 Vrms for 1min. (Detection current: 10mA)
	Surge breakdown voltage (Initial)	Between open contacts	1,500 V (10×160μs) (FCC Part 68)
		Between contacts and coil	2,500 V (2×10μs) (Telcordia)
	Temperature rise (at 20°C 68°F)	Max. 50°C (By resistive method, nominal coil voltage applied to the coil; contact carrying current: 1A.)	
	Operate time [Set time] (at 20°C 68°F)	Max. 5 ms [Max. 5 ms] (Nominal coil voltage applied to the coil, excluding contact bounce time.)	
Release time [Reset time] (at 20°C 68°F)	Max. 5 ms [Max. 5 ms] (Nominal coil voltage applied to the coil, excluding contact bounce time.) (without diode)		
Mechanical characteristics	Shock resistance	Functional	Min. 750 m/s <sup>2</sup> (Half-wave pulse of sine wave: 6 ms; detection time: 10μs.)
		Destructive	Min. 1,000 m/s <sup>2</sup> (Half-wave pulse of sine wave: 6 ms.)
	Vibration resistance	Functional	10 to 55 Hz at double amplitude of 3.3 mm (Detection time: 10μs.)
		Destructive	10 to 55 Hz at double amplitude of 5 mm
Expected life	Mechanical	Min. 5×10 <sup>7</sup> (at 180 cpm)	
	Electrical (Standard contact)	Min. 2×10 <sup>5</sup> (1 A 30 V DC resistive) (at 20 cpm)	
Conditions	Conditions for operation, transport and storage*2	Ambient temperature: -40°C to +70°C -40°F to +158°F; Humidity: 5 to 85% R.H. (Not freezing and condensing at low temperature)	
	Max. operating speed (at rated load)	20 cpm	
Unit weight		Approx. 2 g .071 oz	

Notes: \*1 This value can change due to the switching frequency, environmental conditions, and desired reliability level, therefore it is recommended to check this with the actual load. AgPd contact type is available for low level load switching (10V DC, 10mA max. level).  
\*2 Refer to "AMBIENT ENVIRONMENT" in GENERAL APPLICATION GUIDELINES.

REFERENCE DATA

1. Maximum switching capacity



2. Life curve



3. Mechanical life

Tested sample: TXS2-4.5V, 10 pcs.  
Operating speed: 180 cpm



4. Electrical life (1 A 30 V DC resistive load)

Tested sample: TXS2-4.5V, 6 pcs.

Operating speed: 20 cpm

Change of pick-up and drop-out voltage

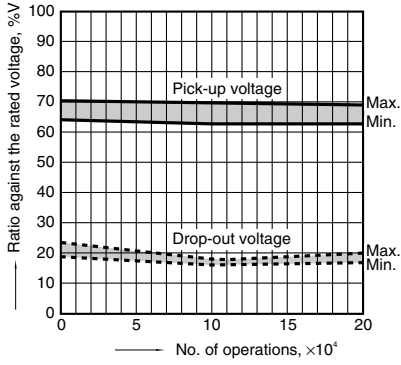

Change of contact resistance

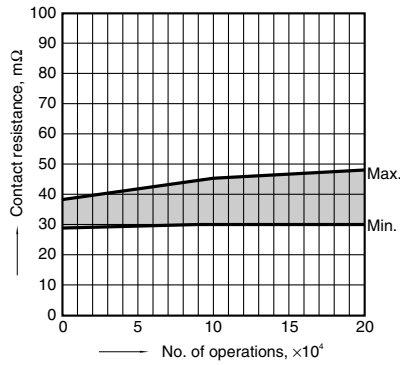

5-(1). Coil temperature rise

Tested sample: TXS2-4.5V, 6 pcs.

Point measured: Inside the coil

Ambient temperature: 25°C 77°F, 70°C 158°F

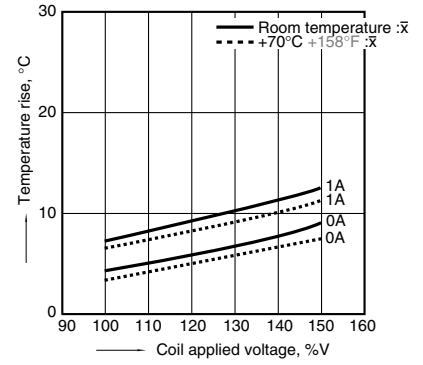

5-(2). Coil temperature rise

Tested sample: TXS2-24V, 6 pcs.

Point measured: Inside the coil

Ambient temperature: 25°C 77°F, 70°C 158°F

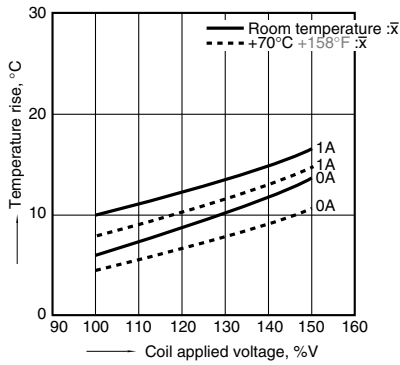

6-(1). Operate and release time (with diode)

Tested sample: TXS2-4.5V, 10 pcs.

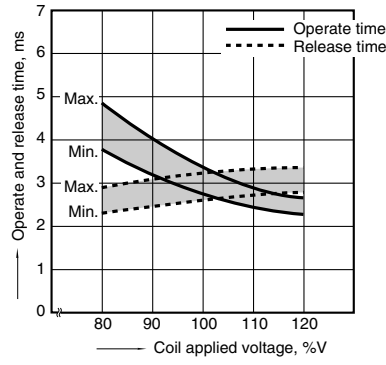

6-(2). Operate and release time (without diode)

Tested sample: TXS2-4.5V, 10 pcs.

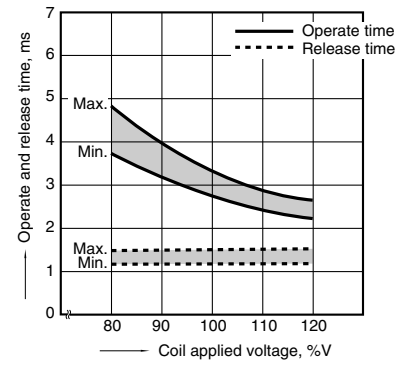

7. Ambient temperature characteristics

Tested sample: TXS2-4.5V, 5 pcs.

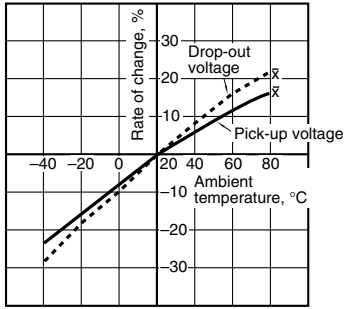

8-(1). High frequency characteristics (Isolation)

Tested sample: TXS2-4.5V, 2 pcs.

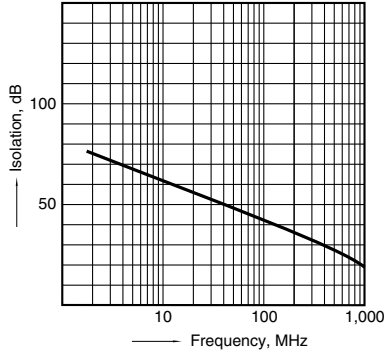

8-(2). High frequency characteristics (Insertion loss)

Tested sample: TXS2-4.5V, 2 pcs.

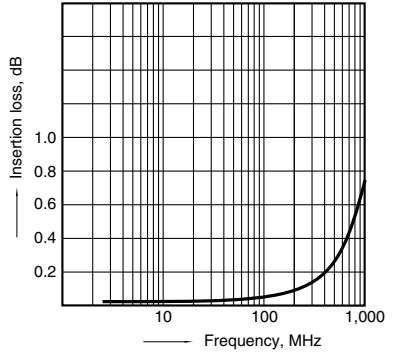

9-(1). Malfunctional shock (single side stable)

Tested sample: TXS2-4.5V, 6 pcs.



9-(2). Malfunctional shock (latching)

Tested sample: TXS2-LT-4.5V, 6 pcs.



10. Thermal electromotive force

Tested sample: TXS2-4.5V, 10 pcs.

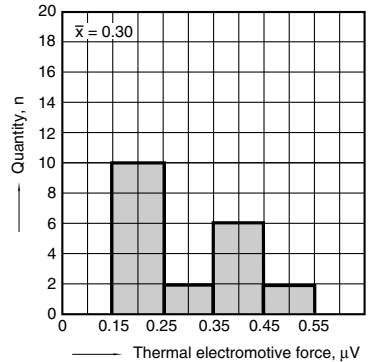

11-(1). Influence of adjacent mounting  
Tested sample: TXS2-4.5V, 6 pcs.



11-(2). Influence of adjacent mounting  
Tested sample: TXS2-4.5V, 6 pcs.



11-(3). Influence of adjacent mounting  
Tested sample: TXS2-4.5V, 6 pcs.



12. Pulse dialing test  
(35 mA 48V DC wire spring relay load)  
Tested sample: TXS2-4.5V, 6 pcs.



Change of pick-up and drop-out voltage



Change of contact resistance



Note: Data of surface-mount type are the same as those of PC board terminal type.

**DIMENSIONS** (mm inch) The CAD data of the products with a **CAD Data** mark can be downloaded from: <http://industrial.panasonic.com/ac/e/>

**1. Standard PC board terminal and Self clinching terminal**

**CAD Data**

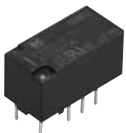

Type	External dimensions (General tolerance: $\pm 0.3 \pm 0.12$ )		PC board pattern (Bottom view) (Tolerance: $\pm 0.1 \pm 0.04$ )	
	Single side stable type	2 coil latching type	Single side stable type	2 coil latching type
Standard PC board terminal				

**Schematic (Bottom view)**



2. Surface-mount terminal

CAD Data



Type	External dimensions (General tolerance: $\pm 0.3 \pm 0.12$ )		Suggested mounting pad (Top view) (Tolerance: $\pm 0.1 \pm 0.04$ )	
	Single side stable type	2 coil latching type	Single side stable type	2 coil latching type
SA type				

Schematic (Top view)

Single side stable

2 coil latching

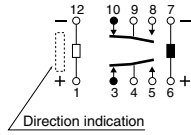
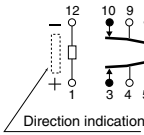

(Deenergized condition)

(Reset condition)

NOTES

1. Packing style

1) The relay is packed in a tube with the relay orientation mark on the left side, as shown in the figure below.

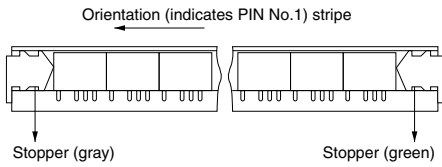

2) Tape and reel packing (surface-mount terminal type)

(1) Tape dimensions

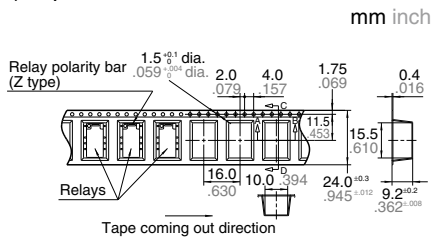

(2) Dimensions of plastic reel

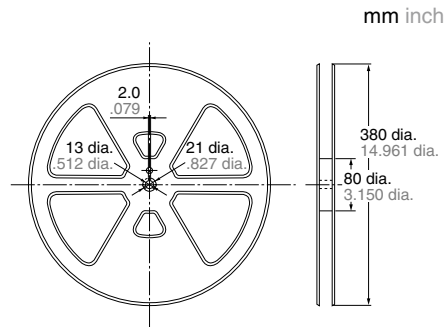

2. Automatic insertion

To maintain the internal function of the relay, the chucking pressure should not exceed the values below.

Chucking pressure in the direction A:

4.9 N {500gf} or less

Chucking pressure in the direction B:

9.8 N {1 kgf} or less

Chucking pressure in the direction C:

9.8 N {1 kgf} or less

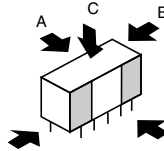

Please chuck the portion. Avoid chucking the center of the relay. In addition, excessive chucking pressure to the pinpoint of the relay should be avoided.

For general cautions for use, please refer to the "Cautions for use of Signal Relays" or "General Application Guidelines".

# Mouser Electronics

Authorized Distributor

Click to View Pricing, Inventory, Delivery & Lifecycle Information:

## Panasonic:

[TXS2-1.5V](#) [TXS2-L-1.5V](#) [TXS2-L-12V](#) [TXS2-L2-1.5V](#) [TXS2-L2-24V](#) [TXS2-L2-3V](#) [TXS2-L-24V](#) [TXS2-L2-6V](#) [TXS2-L2-9V](#) [TXS2-L-3V](#) [TXS2-L-4.5V](#) [TXS2-L-6V](#) [TXS2-L-9V](#) [TXS2SA-1.5V](#) [TXS2SA-12V-Z](#) [TXS2SA-24V-Z](#) [TXS2SA-3V-Z](#) [TXS2SA-4.5V-1](#) [TXS2SA-4.5V-X](#) [TXS2SA-6V](#) [TXS2SA-9V](#) [TXS2SA-9V-Z](#) [TXS2SA-L-1.5V](#) [TXS2SA-L-12V](#) [TXS2SA-L2-12V](#) [TXS2SA-L2-12V-Z](#) [TXS2SA-L2-24V](#) [TXS2SA-L2-24V-Z](#) [TXS2SA-L2-3V](#) [TXS2SA-L2-4.5V-X](#) [TXS2SA-L2-4.5V-Z](#) [TXS2SA-L-24V](#) [TXS2SA-L-24V-Z](#) [TXS2SA-L-3V](#) [TXS2SA-L-4.5V](#) [TXS2SA-L-4.5V-Z](#) [TXS2SS-1.5V](#) [TXS2SS-1.5V-X](#) [TXS2SS-1.5V-Z](#) [TXS2SS-24V](#) [TXS2SS-24V-Z](#) [TXS2SS-3V](#) [TXS2SS-3V-Z](#) [TXS2SS-4.5V-Z](#) [TXS2SS-6V](#) [TXS2SS-L-12V](#) [TXS2SS-L2-12V](#) [TXS2SS-L2-3V](#) [TXS2SS-L2-4.5V](#) [TXS2SS-L-3V-Z](#) [TXS2SA-L2-3V-Z](#) [TXS2SA-4.5V-Z](#) [TXS2-6V](#) [TXS2SS-12V-Z](#) [TXS2SA-24V](#) [TXS2SA-L-5V](#) [TXS2SA-L-5V-Z](#) [TXS2SA-LT-1.5V-1](#) [TXS2SA-LT-1.5V-1-Z](#) [TXS2SA-LT-12V-1](#) [TXS2SA-LT-12V-1-Z](#) [TXS2SA-LT-24V-1](#) [TXS2SA-LT-24V-1-Z](#) [TXS2SA-LT-3V](#) [TXS2SA-LT-3V-1-Z](#) [TXS2SA-LT-4.5V](#) [TXS2SA-LT-4.5V-1-Z](#) [TXS2SA-LT-6V-1](#) [TXS2SA-LT-6V-1-Z](#) [TXS2SA-LT-9V-1](#) [TXS2SA-LT-9V-1-Z](#)

Компания «Life Electronics» занимается поставками электронных компонентов импортного и отечественного производства от производителей и со складов крупных дистрибьюторов Европы, Америки и Азии.

С конца 2013 года компания активно расширяет линейку поставок компонентов по направлению коаксиальный кабель, кварцевые генераторы и конденсаторы (керамические, пленочные, электролитические), за счёт заключения дистрибьюторских договоров

Мы предлагаем:

- Конкурентоспособные цены и скидки постоянным клиентам.
- Специальные условия для постоянных клиентов.
- Подбор аналогов.
- Поставку компонентов в любых объемах, удовлетворяющих вашим потребностям.
- Приемлемые сроки поставки, возможна ускоренная поставка.
- Доставку товара в любую точку России и стран СНГ.
- Комплексную поставку.
- Работу по проектам и поставку образцов.
- Формирование склада под заказчика.
- Сертификаты соответствия на поставляемую продукцию (по желанию клиента).
- Тестирование поставляемой продукции.
- Поставку компонентов, требующих военную и космическую приемку.
- Входной контроль качества.
- Наличие сертификата ISO.

В составе нашей компании организован Конструкторский отдел, призванный помогать разработчикам, и инженерам.

Конструкторский отдел помогает осуществить:

- Регистрацию проекта у производителя компонентов.
- Техническую поддержку проекта.
- Защиту от снятия компонента с производства.
- Оценку стоимости проекта по компонентам.
- Изготовление тестовой платы монтаж и пусконаладочные работы.



Тел: +7 (812) 336 43 04 (многоканальный)  
Email: org@lifeelectronics.ru