

## Important notice

Dear Customer,

On 7 February 2017 the former NXP Standard Product business became a new company with the tradename **Nexperia**. Nexperia is an industry leading supplier of Discrete, Logic and PowerMOS semiconductors with its focus on the automotive, industrial, computing, consumer and wearable application markets

In data sheets and application notes which still contain NXP or Philips Semiconductors references, use the references to Nexperia, as shown below.

Instead of <http://www.nxp.com>, <http://www.philips.com/> or <http://www.semiconductors.philips.com/>, use <http://www.nexperia.com>

Instead of [sales.addresses@www.nxp.com](mailto:sales.addresses@www.nxp.com) or [sales.addresses@www.semiconductors.philips.com](mailto:sales.addresses@www.semiconductors.philips.com), use [salesaddresses@nexperia.com](mailto:salesaddresses@nexperia.com) (email)

Replace the copyright notice at the bottom of each page or elsewhere in the document, depending on the version, as shown below:

- © NXP N.V. (year). All rights reserved or © Koninklijke Philips Electronics N.V. (year). All rights reserved

Should be replaced with:

- © **Nexperia B.V. (year). All rights reserved.**

If you have any questions related to the data sheet, please contact our nearest sales office via e-mail or telephone (details via [salesaddresses@nexperia.com](mailto:salesaddresses@nexperia.com)). Thank you for your cooperation and understanding,

Kind regards,

Team Nexperia

# DATA SHEET

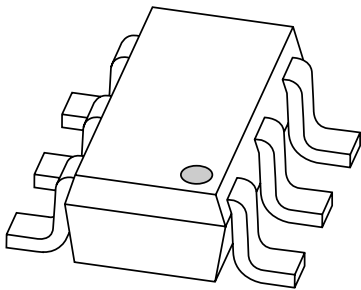

**PBSS4240DPN**  
40 V low  $V_{CEsat}$  NPN/PNP  
transistor

Product data sheet

2003 Feb 20

# 40 V low $V_{CEsat}$ NPN/PNP transistor

# PBSS4240DPN

### FEATURES

- Low collector-emitter saturation voltage  $V_{CEsat}$
- High collector current capability  $I_C$  and  $I_{CM}$
- High collector current gain  $h_{FE}$  at high  $I_C$
- High efficiency leading to reduced heat generation
- Reduced printed-circuit board area requirements.

### APPLICATIONS

- Power management:
  - Complementary MOSFET driver
  - Dual supply line switching.
- Peripheral driver:
  - Half and full bridge motor drivers
  - Multi-phase stepper motor driver.

### DESCRIPTION

NPN/PNP low  $V_{CEsat}$  transistor pair in a SOT457 (SC-74) plastic package.

### MARKING

TYPE NUMBER	MARKING CODE
PBSS4240DPN	M3

### QUICK REFERENCE DATA

SYMBOL	PARAMETER	MAX.		UNIT
		NPN	PNP	
$V_{CEO}$	emitter-collector voltage	40	-40	V
$I_C$	collector current (DC)	1.35	-1.1	A
$I_{CRP}$	repetitive peak collector current	2	-2	A
$I_{CM}$	peak collector current	3	-3	A
$R_{CEsat}$	equivalent on-resistance	200	260	$m\Omega$

### PINNING

PIN	DESCRIPTION
1, 4	emitter TR1; TR2
2, 5	base TR1; TR2
6, 3	collector TR1; TR2

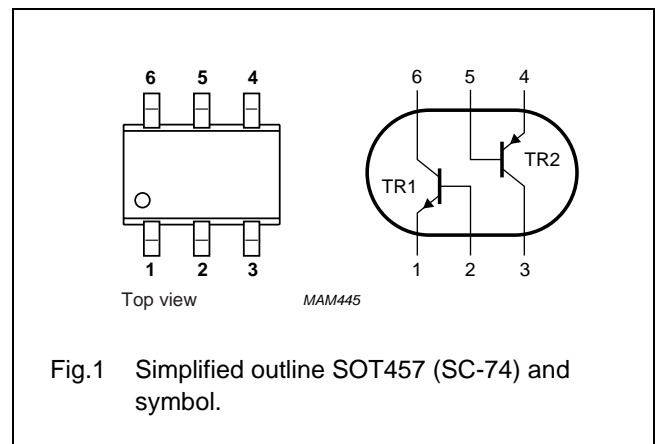

40 V low  $V_{CEsat}$  NPN/PNP transistor

## PBSS4240DPN

**LIMITING VALUES**

In accordance with the Absolute Maximum Rating System (IEC 60134).

SYMBOL	PARAMETER	CONDITIONS	MIN.	MAX.	UNIT
<b>Per transistor unless otherwise specified; for the PNP transistor with negative polarity</b>					
$V_{CBO}$	collector-base voltage	open emitter	–	40	V
$V_{CEO}$	collector-emitter voltage	open base	–	40	V
$V_{EBO}$	emitter-base voltage	open collector	–	5	V
$I_C$	collector current (DC) NPN PNP		–	1.35	A
			–	–1.1	A
			–		
$I_{CRP}$	repetitive peak collector current	note 1	–	2	A
$I_{CM}$	peak collector current	single peak	–	3	A
$I_B$	base current (DC)		–	300	mA
$I_{BM}$	peak base current		–	1	A
$P_{tot}$	total power dissipation	$T_{amb} \leq 25\text{ °C}$ ; note 2	–	370	mW
		$T_{amb} \leq 25\text{ °C}$ ; note 3	–	310	mW
		$T_{amb} \leq 25\text{ °C}$ ; note 1	–	1.1	W
$T_{stg}$	storage temperature		–65	+150	°C
$T_j$	junction temperature		–	150	°C
$T_{amb}$	operating ambient temperature		–65	+150	°C
<b>Per device</b>					
$P_{tot}$	total power dissipation	$T_{amb} \leq 25\text{ °C}$ ; note 2	–	600	mW

**Notes**

- Operated under pulsed conditions: duty cycle  $\delta \leq 20\%$ ; pulse width  $t_p \leq 10\text{ ms}$ ; mounting pad for collector standard footprint.
- Device mounted on a printed-circuit board; single-sided copper; tinplated; mounting pad for collector  $1\text{ cm}^2$ .
- Device mounted on a printed-circuit board; single-sided copper; tinplated; standard footprint.

**THERMAL CHARACTERISTICS**

SYMBOL	PARAMETER	CONDITIONS	VALUE	UNIT
<b>Per transistor</b>				
$R_{th\ j-a}$	thermal resistance from junction to ambient	in free air; note 1	340	K/W
		in free air; note 2	110	K/W

**Notes**

- Device mounted on a printed-circuit board, single-sided copper, tinplated, mounting pad for collector  $1\text{ cm}^2$ .
- Operated under pulsed conditions: pulse width  $t_p \leq 10\text{ ms}$ ; duty cycle  $\delta \leq 0.20$ ; mounting pad for collector standard footprint.

40 V low  $V_{CEsat}$  NPN/PNP transistor

## PBSS4240DPN

## CHARACTERISTICS

$T_{amb} = 25\text{ }^{\circ}\text{C}$  unless otherwise specified.

SYMBOL	PARAMETER	CONDITIONS	MIN.	TYP.	MAX.	UNIT
<b>Per transistor unless otherwise specified; for the PNP transistor with negative polarity</b>						
$I_{CBO}$	collector-base cut-off current	$V_{CB} = 40\text{ V}; I_E = 0$	–	–	100	nA
		$V_{CB} = 40\text{ V}; I_E = 0; T_j = 150\text{ }^{\circ}\text{C}$	–	–	50	$\mu\text{A}$
$I_{CEO}$	collector-emitter cut-off current	$V_{CE} = 30\text{ V}; I_B = 0$	–	–	100	nA
$I_{EBO}$	emitter-base cut-off current	$V_{EB} = 5\text{ V}; I_C = 0$	–	–	100	nA
$h_{FE}$	DC current gain	$V_{CE} = 5\text{ V}; I_C = 1\text{ mA}$	300	–	–	
$f_T$	transition frequency	$I_C = 50\text{ mA}; V_{CE} = 10\text{ V};$ $f = 100\text{ MHz}$	150	–	–	MHz
$C_c$	collector capacitance	$V_{CB} = 10\text{ V}; I_E = I_e = 0;$ $f = 1\text{ MHz}$	–	–	12	pF
<b>TR1 (NPN)</b>						
$h_{FE}$	DC current gain	$V_{CE} = 5\text{ V}; I_C = 500\text{ mA}$	300	–	900	
		$V_{CE} = 5\text{ V}; I_C = 1\text{ A}$	200	–	–	
		$V_{CE} = 5\text{ V}; I_C = 2\text{ A};$ note 1	75	–	–	
$V_{CEsat}$	collector-emitter saturation voltage	$I_C = 100\text{ mA}; I_B = 1\text{ mA}$	–	60	75	mV
		$I_C = 500\text{ mA}; I_B = 50\text{ mA}$	–	80	100	mV
		$I_C = 1\text{ A}; I_B = 100\text{ mA}$	–	150	200	mV
		$I_C = 2\text{ A}; I_B = 200\text{ mA};$ note 1	–	300	400	mV
$V_{BEsat}$	base-emitter saturation voltage	$I_C = 1\text{ A}; I_B = 100\text{ mA}$	–	–	1.2	V
$V_{BEon}$	base-emitter turn-on voltage	$V_{CE} = 5\text{ V}; I_C = 1\text{ A}$	–	–	1.1	V
$R_{CEsat}$	equivalent on-resistance	$I_C = 1\text{ A}; I_B = 100\text{ mA}$	–	–	200	$\text{m}\Omega$
<b>TR2 (PNP)</b>						
$h_{FE}$	DC current gain	$V_{CE} = -5\text{ V}; I_C = -100\text{ mA}$	300	–	800	
		$V_{CE} = -5\text{ V}; I_C = -500\text{ mA}$	250	–	–	
		$V_{CE} = -5\text{ V}; I_C = -1\text{ A}$	160	–	–	
		$V_{CE} = -5\text{ V}; I_C = -2\text{ A};$ note 1	50	–	–	
$V_{CEsat}$	saturation voltage	$I_C = -100\text{ mA}; I_B = -1\text{ mA}$	–	-90	-120	mV
		$I_C = -500\text{ mA}; I_B = -50\text{ mA}$	–	-100	-145	mV
		$I_C = -1\text{ A}; I_B = -100\text{ mA}$	–	-180	-260	mV
		$I_C = -2\text{ A}; I_B = -200\text{ mA};$ note 1	–	-400	-530	mV
$V_{BEsat}$	saturation voltage	$I_C = -1\text{ A}; I_B = -50\text{ mA}$	–	–	-1.1	V
$V_{BEon}$	base-emitter turn-on voltage	$V_{CE} = -5\text{ V}; I_C = -1\text{ A}$	–	–	-1	V
$R_{CEsat}$	equivalent on-resistance	$I_C = -1\text{ A}; I_B = -100\text{ mA};$ note 1	–	–	260	$\text{m}\Omega$

## Note

1. Pulse test:  $t_p \leq 300\text{ }\mu\text{s}; \delta \leq 0.02$ .

40 V low  $V_{CEsat}$  NPN/PNP transistor

PBSS4240DPN

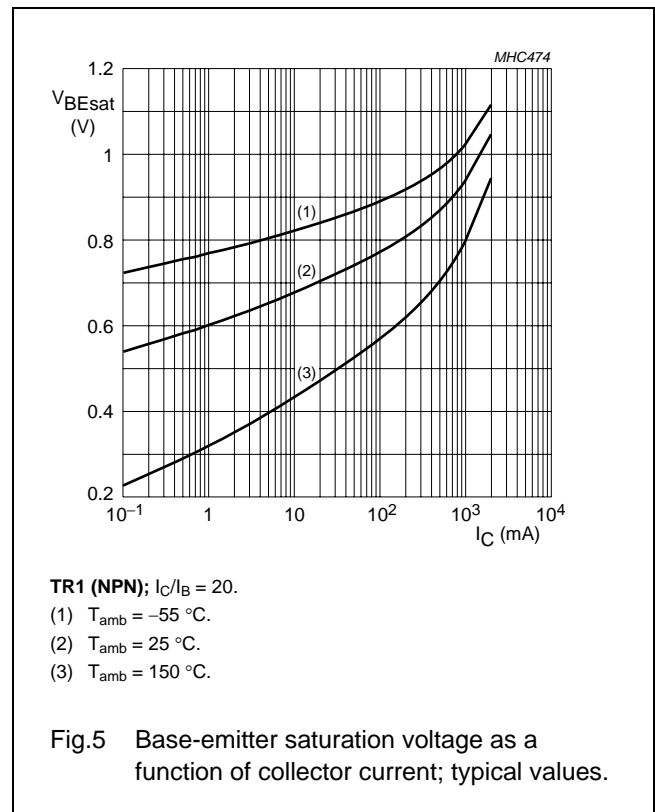
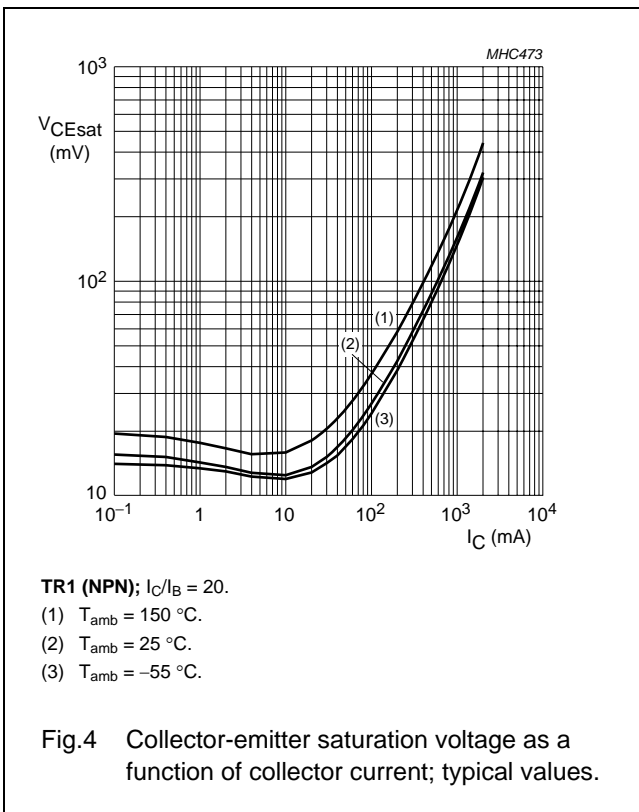
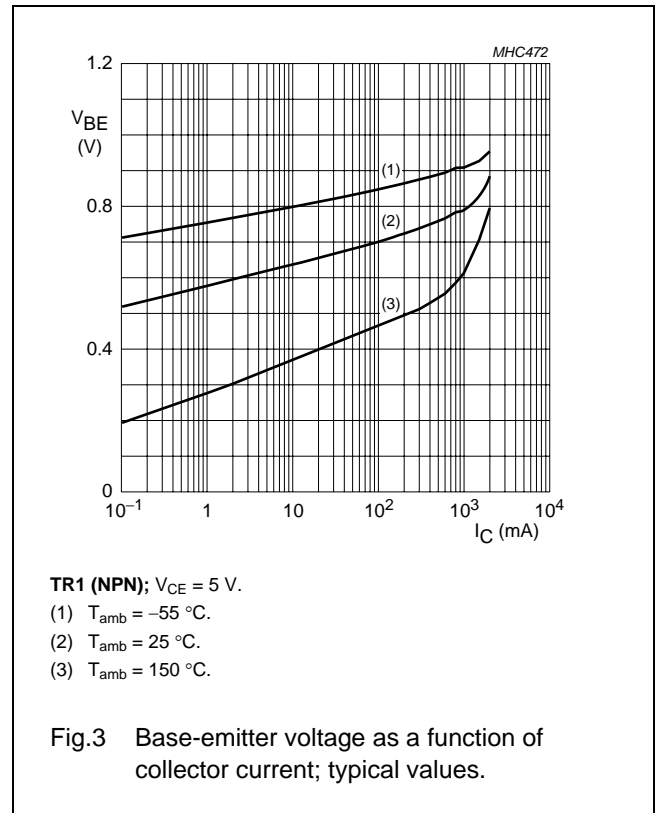
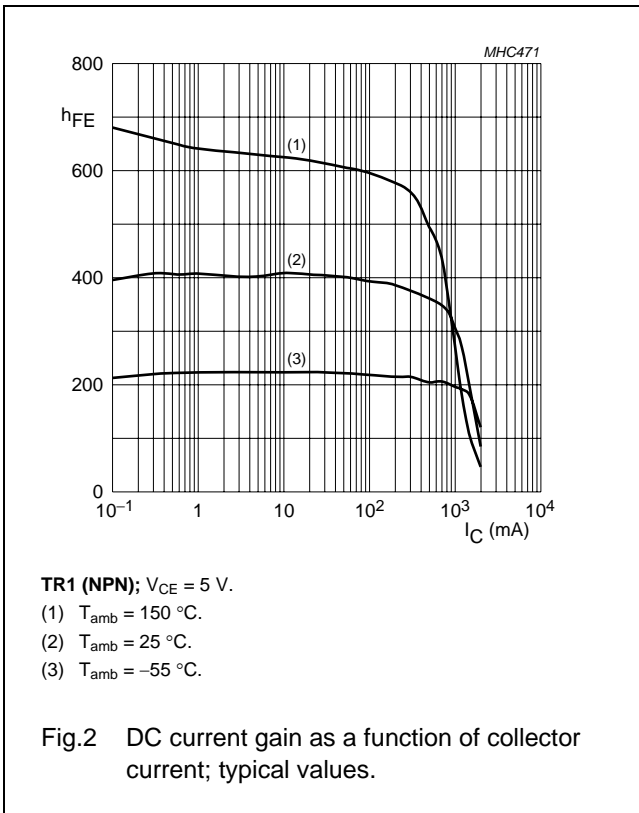

40 V low  $V_{CEsat}$  NPN/PNP transistor

PBSS4240DPN

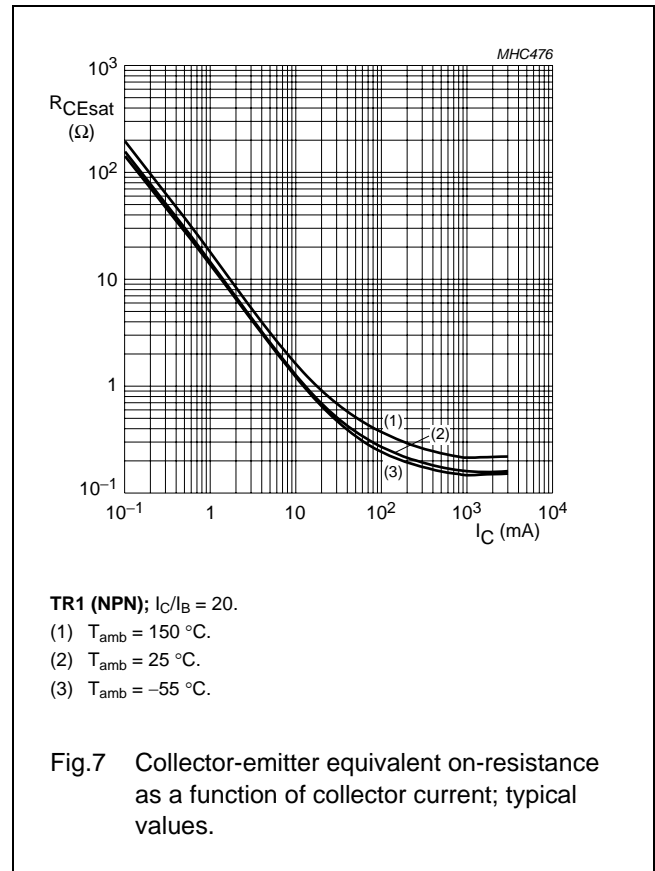
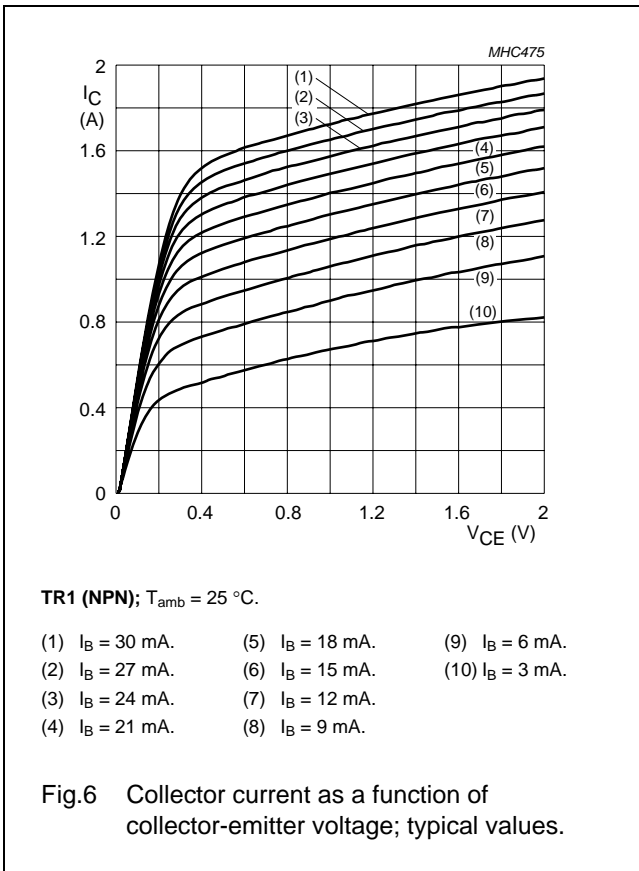

40 V low  $V_{CEsat}$  NPN/PNP transistor

PBSS4240DPN

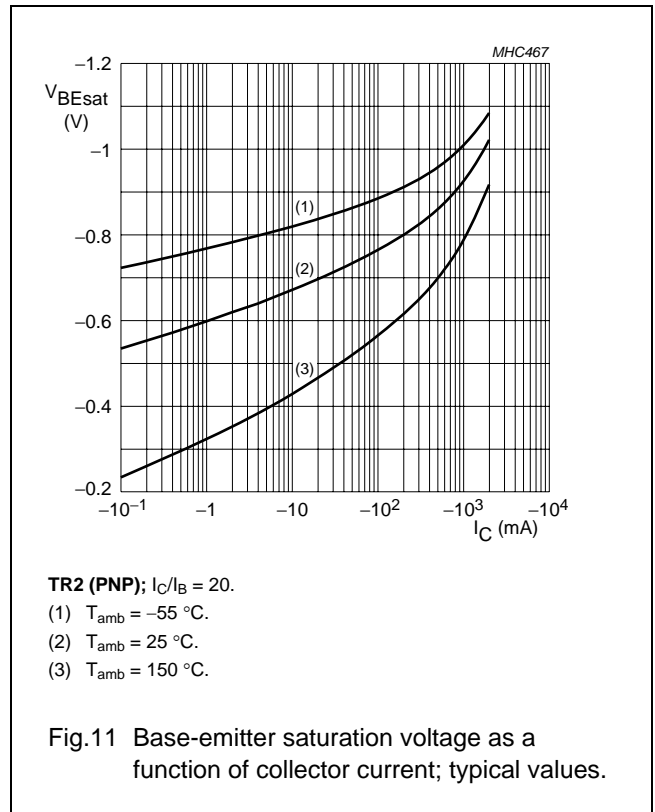
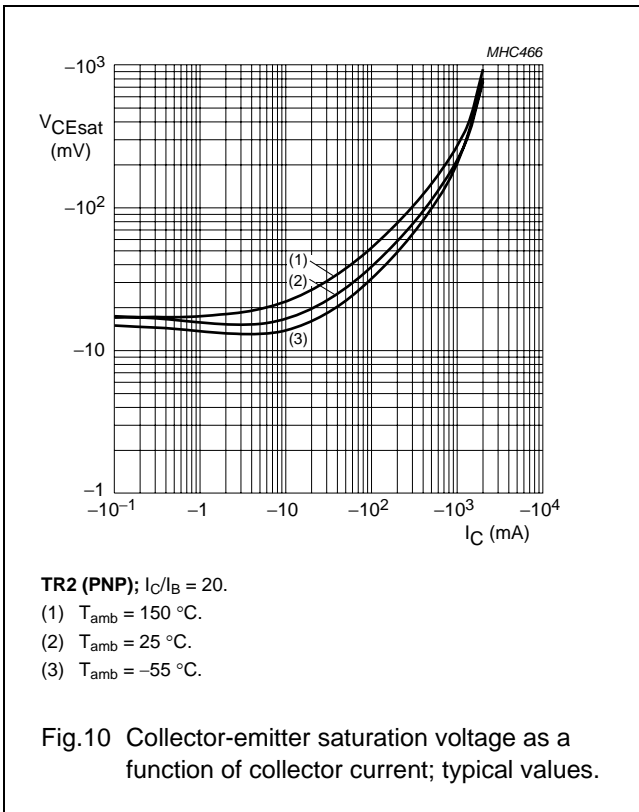
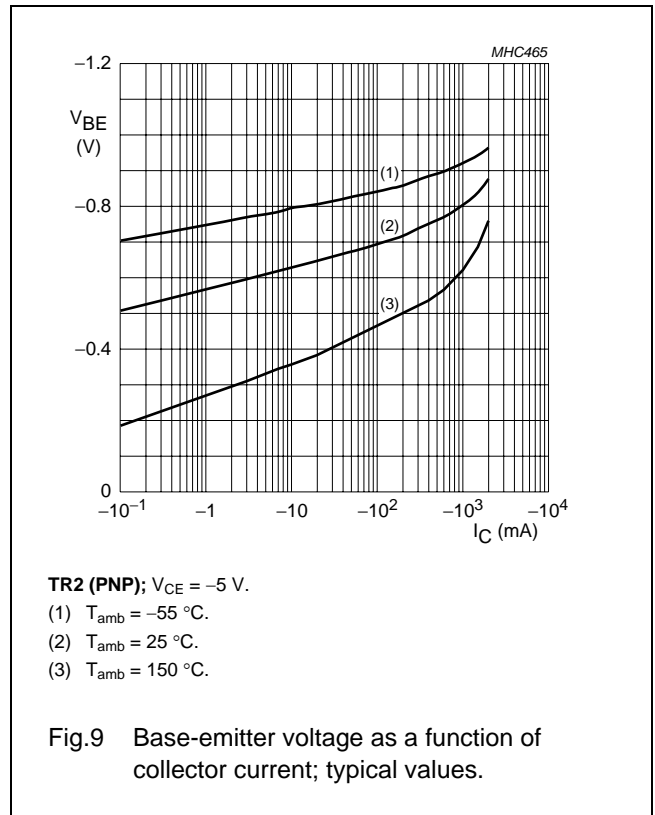
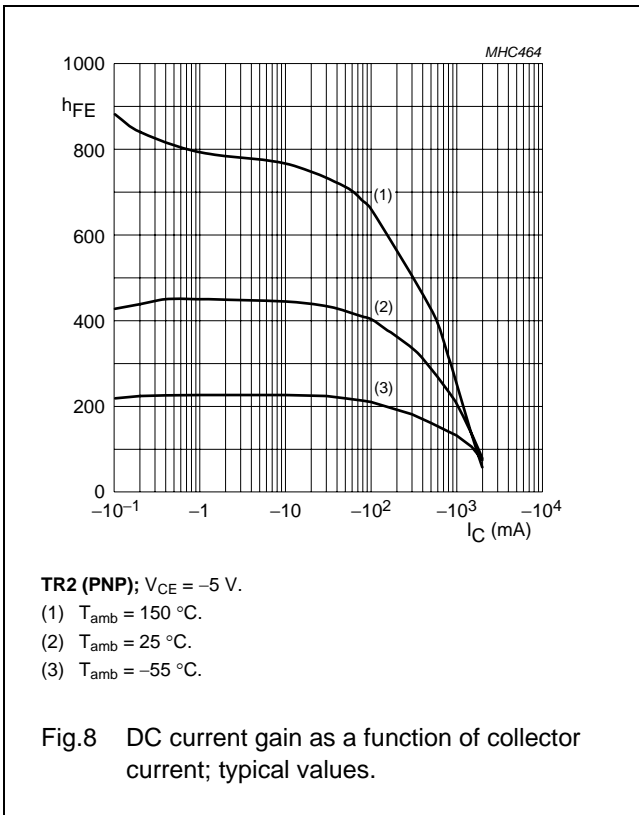



40 V low  $V_{CEsat}$  NPN/PNP transistor

PBSS4240DPN

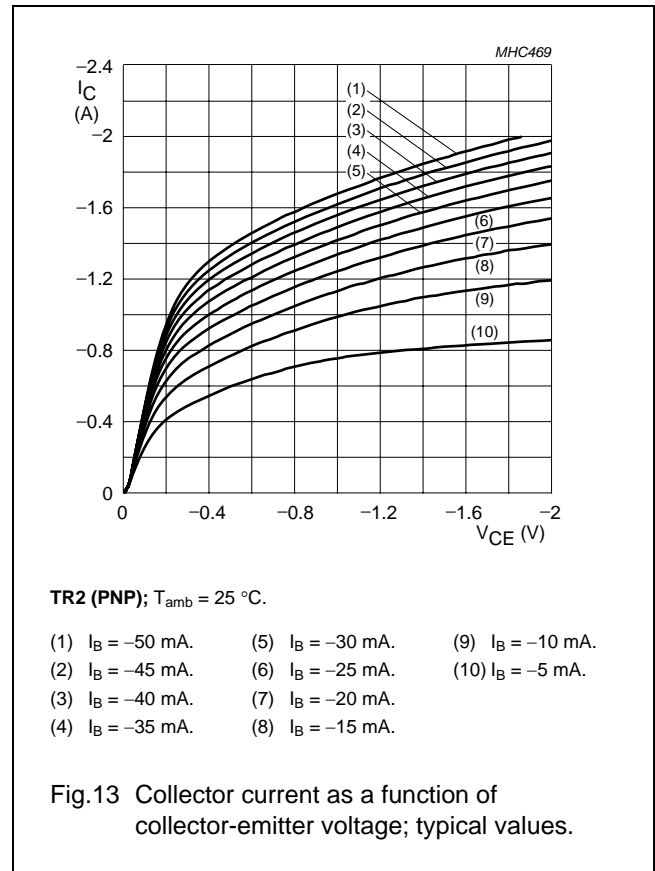
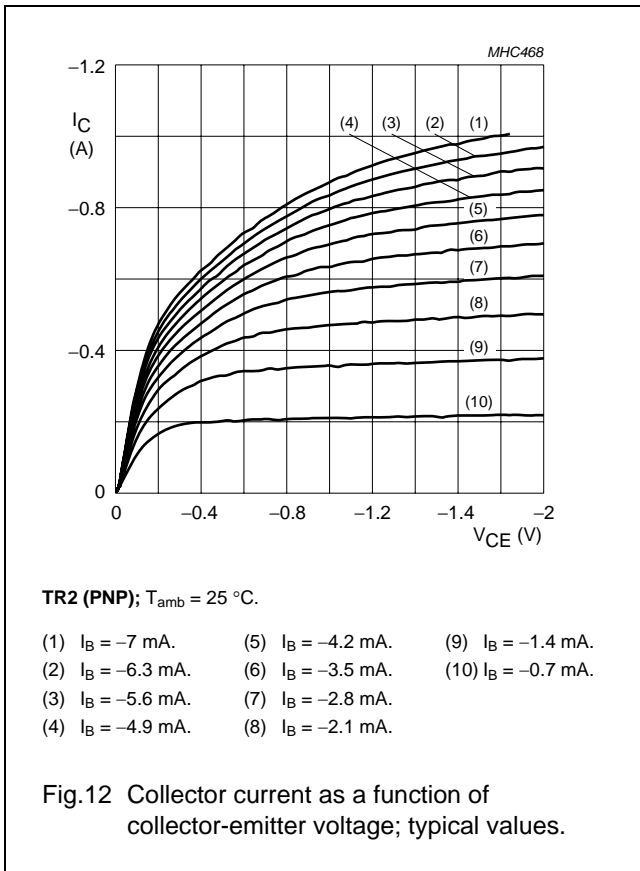

40 V low  $V_{CEsat}$  NPN/PNP transistor

PBSS4240DPN

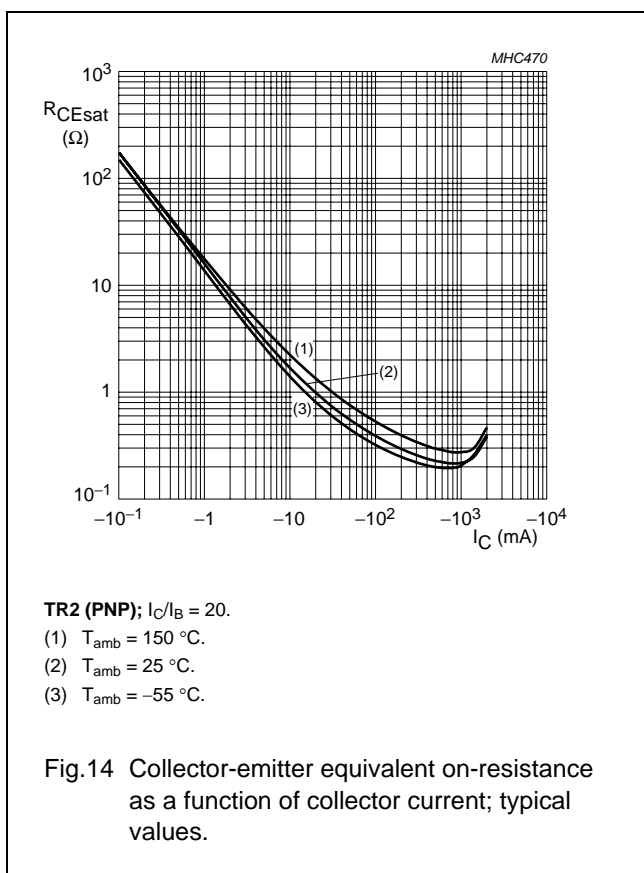

40 V low  $V_{CEsat}$  NPN/PNP transistor

PBSS4240DPN

PACKAGE OUTLINE

Plastic surface mounted package; 6 leads

SOT457

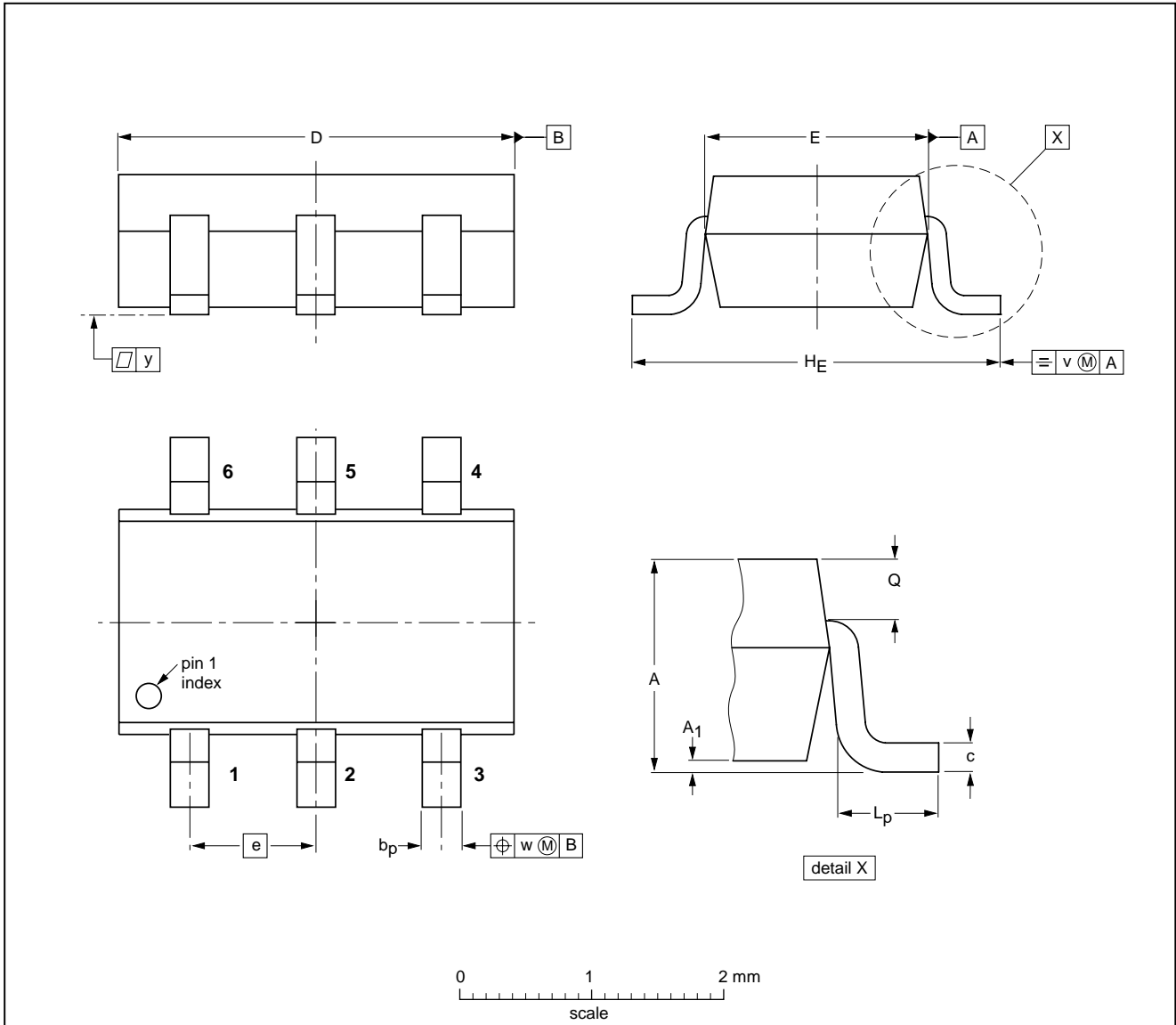

DIMENSIONS (mm are the original dimensions)

UNIT	A	A <sub>1</sub>	b <sub>p</sub>	c	D	E	e	H <sub>E</sub>	L <sub>p</sub>	Q	v	w	y
mm	1.1 0.9	0.1 0.013	0.40 0.25	0.26 0.10	3.1 2.7	1.7 1.3	0.95	3.0 2.5	0.6 0.2	0.33 0.23	0.2	0.2	0.1

OUTLINE VERSION	REFERENCES				EUROPEAN PROJECTION	ISSUE DATE
	IEC	JEDEC	EIAJ			
SOT457			SC-74			97-02-28 01-05-04

40 V low  $V_{CEsat}$  NPN/PNP transistor

PBSS4240DPN

**DATA SHEET STATUS**

DOCUMENT STATUS <sup>(1)</sup>	PRODUCT STATUS <sup>(2)</sup>	DEFINITION
Objective data sheet	Development	This document contains data from the objective specification for product development.
Preliminary data sheet	Qualification	This document contains data from the preliminary specification.
Product data sheet	Production	This document contains the product specification.

**Notes**

1. Please consult the most recently issued document before initiating or completing a design.
2. The product status of device(s) described in this document may have changed since this document was published and may differ in case of multiple devices. The latest product status information is available on the Internet at URL <http://www.nxp.com>.

**DISCLAIMERS**

**General** — Information in this document is believed to be accurate and reliable. However, NXP Semiconductors does not give any representations or warranties, expressed or implied, as to the accuracy or completeness of such information and shall have no liability for the consequences of use of such information.

**Right to make changes** — NXP Semiconductors reserves the right to make changes to information published in this document, including without limitation specifications and product descriptions, at any time and without notice. This document supersedes and replaces all information supplied prior to the publication hereof.

**Suitability for use** — NXP Semiconductors products are not designed, authorized or warranted to be suitable for use in medical, military, aircraft, space or life support equipment, nor in applications where failure or malfunction of an NXP Semiconductors product can reasonably be expected to result in personal injury, death or severe property or environmental damage. NXP Semiconductors accepts no liability for inclusion and/or use of NXP Semiconductors products in such equipment or applications and therefore such inclusion and/or use is at the customer's own risk.

**Applications** — Applications that are described herein for any of these products are for illustrative purposes only. NXP Semiconductors makes no representation or warranty that such applications will be suitable for the specified use without further testing or modification.

**Limiting values** — Stress above one or more limiting values (as defined in the Absolute Maximum Ratings System of IEC 60134) may cause permanent damage to

the device. Limiting values are stress ratings only and operation of the device at these or any other conditions above those given in the Characteristics sections of this document is not implied. Exposure to limiting values for extended periods may affect device reliability.

**Terms and conditions of sale** — NXP Semiconductors products are sold subject to the general terms and conditions of commercial sale, as published at <http://www.nxp.com/profile/terms>, including those pertaining to warranty, intellectual property rights infringement and limitation of liability, unless explicitly otherwise agreed to in writing by NXP Semiconductors. In case of any inconsistency or conflict between information in this document and such terms and conditions, the latter will prevail.

**No offer to sell or license** — Nothing in this document may be interpreted or construed as an offer to sell products that is open for acceptance or the grant, conveyance or implication of any license under any copyrights, patents or other industrial or intellectual property rights.

**Export control** — This document as well as the item(s) described herein may be subject to export control regulations. Export might require a prior authorization from national authorities.

**Quick reference data** — The Quick reference data is an extract of the product data given in the Limiting values and Characteristics sections of this document, and as such is not complete, exhaustive or legally binding.

# ***NXP Semiconductors***

## **Customer notification**

This data sheet was changed to reflect the new company name NXP Semiconductors. No changes were made to the content, except for the legal definitions and disclaimers.

## **Contact information**

For additional information please visit: **<http://www.nxp.com>**

For sales offices addresses send e-mail to: **[salesaddresses@nxp.com](mailto:salesaddresses@nxp.com)**

© NXP B.V. 2009

All rights are reserved. Reproduction in whole or in part is prohibited without the prior written consent of the copyright owner.

The information presented in this document does not form part of any quotation or contract, is believed to be accurate and reliable and may be changed without notice. No liability will be accepted by the publisher for any consequence of its use. Publication thereof does not convey nor imply any license under patent- or other industrial or intellectual property rights.

Printed in The Netherlands

613514/01/pp12

Date of release: 2003 Feb 20

Document order number: 9397 750 10783



Компания «Life Electronics» занимается поставками электронных компонентов импортного и отечественного производства от производителей и со складов крупных дистрибьюторов Европы, Америки и Азии.

С конца 2013 года компания активно расширяет линейку поставок компонентов по направлению коаксиальный кабель, кварцевые генераторы и конденсаторы (керамические, пленочные, электролитические), за счёт заключения дистрибьюторских договоров

Мы предлагаем:

- Конкуренспособные цены и скидки постоянным клиентам.
- Специальные условия для постоянных клиентов.
- Подбор аналогов.
- Поставку компонентов в любых объемах, удовлетворяющих вашим потребностям.
- Приемлемые сроки поставки, возможна ускоренная поставка.
- Доставку товара в любую точку России и стран СНГ.
- Комплексную поставку.
- Работу по проектам и поставку образцов.
- Формирование склада под заказчика.
- Сертификаты соответствия на поставляемую продукцию (по желанию клиента).
- Тестирование поставляемой продукции.
- Поставку компонентов, требующих военную и космическую приемку.
- Входной контроль качества.
- Наличие сертификата ISO.

В составе нашей компании организован Конструкторский отдел, призванный помогать разработчикам, и инженерам.

Конструкторский отдел помогает осуществить:

- Регистрацию проекта у производителя компонентов.
- Техническую поддержку проекта.
- Защиту от снятия компонента с производства.
- Оценку стоимости проекта по компонентам.
- Изготовление тестовой платы монтаж и пусконаладочные работы.



Тел: +7 (812) 336 43 04 (многоканальный)  
Email: [org@lifeelectronics.ru](mailto:org@lifeelectronics.ru)