

Optocoupler, Phototriac Output, Zero Crossing, High dV/dt, Low Input Current

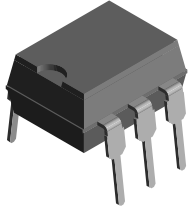

i179030



DESCRIPTION

The IL410/IL4108 consists of a GaAs IRLED optically coupled to a photosensitive zero crossing TRIAC network. The TRIAC consists of two inverse parallel connected monolithic SCRs. These three semiconductors are assembled in a six pin dual in-line package.

High input sensitivity is achieved by using an emitter follower phototransistor and a cascaded SCR predriver resulting in an LED trigger current of less than 2.0 mA (DC).

The IL410/IL4108 uses two discrete SCRs resulting in a commutating dV/dt greater than 10 kV/ms. The use of a proprietary dV/dt clamp results in a static dV/dt of greater than 10 kV/ms. This clamp circuit has a MOSFET that is enhanced when high dV/dt spikes occur between MT1 and MT2 of the TRIAC. When conducting, the FET clamps the base of the phototransistor, disabling the first stage SCR predriver.

The zero cross line voltage detection circuit consists of two enhancement MOSFETS and a photodiode. The inhibit voltage of the network is determined by the enhancement voltage of the N-channel FET. The P-channel FET is enabled by a photocurrent source that permits the FET to conduct the main voltage to gate on the N-channel FET. Once the main voltage can enable the N-channel, it clamps the base of the phototransistor, disabling the first stage SCR predriver.

The 600/800 V blocking voltage permits control of off-line voltages up to 240 VAC, with a safety factor of more than two, and is sufficient for as much as 380 VAC.

The IL410/IL4108 isolates low-voltage logic from 120, 240, and 380 VAC lines to control resistive, inductive, or capacitive loads including motors, solenoids, high current thyristors or TRIAC and relays.

FEATURES

- High input sensitivity
- $I_{FT} = 2.0 \text{ mA}$, $PF = 1.0$
- $I_{FT} = 5.0 \text{ mA}$, $PF \leq 1.0$
- 300 mA on-state current
- Zero voltage crossing detector
- 600/800 V blocking voltage
- High static dV/dt 10 kV/ μs
- Inverse parallel SCRs provide commutating dV/dt >10 kV/ μs
- Very low leakage < 10 μA
- Isolation test voltage 5300 V_{RMS}
- Small 6-pin DIP package
- Lead (Pb)-free component
- Component in accordance to RoHS 2002/95/EC and WEEE 2002/96/EC

RoHS
COMPLIANT

APPLICATIONS

- Solid-state relays
- Industrial controls
- Office equipment
- Consumer appliances

AGENCY APPROVALS

- UL1577, file no. E52744 system code H or J, double protection
- CSA 93751
- FIMKO and BSI IEC 60950; IEC 60065 only for IL4108
- DIN EN 60747-5-2 (VDE 0884)/DIN EN 60747-5-5 pending available with option 1

ORDER INFORMATION

PART	REMARKS
IL410	600 V V_{DRM} , DIP-6
IL4108	800 V V_{DRM} , DIP-6
IL410-X006	600 V V_{DRM} , DIP-6 400 mil (option 6)
IL410-X007	600 V V_{DRM} , SMD-6 (option 7)
IL410-X009	600 V V_{DRM} , SMD-6 (option 9)

Vishay Semiconductors Optocoupler, Phototriac Output, Zero Crossing,
High dV/dt, Low Input Current

ORDER INFORMATION	
PART	REMARKS
IL4108-X006	800 V V_{DRM} , DIP-6 400 mil (option 6)
IL4108-X007	800 V V_{DRM} , SMD-6 (option 7)
IL4108-X009	800 V V_{DRM} , SMD-6 (option 9)

Note

For additional information on the available options refer to option information.

ABSOLUTE MAXIMUM RATINGS (1)					
PARAMETER	TEST CONDITION	PART	SYMBOL	VALUE	UNIT
INPUT					
Reverse voltage			V_R	6.0	V
Forward current			I_F	60	mA
Surge current			I_{FSM}	2.5	A
Power dissipation			P_{diss}	100	mW
Derate from 25 °C				1.33	mW/°C
OUTPUT					
Peak off-state voltage		IL410	V_{DM}	600	V
		IL4108	V_{DM}	800	V
RMS on-state current			I_{TM}	300	mA
Single cycle surge current				3.0	A
Total power dissipation			P_{diss}	500	mW
Derate from 25 °C				6.6	mW/°C
COUPLER					
Isolation test voltage (between emitter and detector, climate per DIN 500414, part 2, Nov. 74)	t = 1.0 min		V_{ISO}	5300	V_{RMS}
Pollution degree (DIN VDE 0109)				2	
Creepage distance				≥ 7.0	mm
Clearance distance				≥ 7.0	mm
Comparative tracking index per DIN IEC 112/VDE 0303 part 1, group IIIa per DIN VDE 6110			CTI	≥ 175	
Isolation resistance	$V_{IO} = 500\text{ V}, T_{amb} = 25\text{ °C}$		R_{IO}	≥ 10^{12}	Ω
	$V_{IO} = 500\text{ V}, T_{amb} = 100\text{ °C}$		R_{IO}	≥ 10^{11}	Ω
Storage temperature range			T_{stg}	- 55 to + 150	°C
Ambient temperature			T_{amb}	- 55 to + 100	°C
Soldering temperature (2)	max. ≤ 10 s dip soldering ≥ 0.5 mm from case bottom		T_{sld}	260	°C

Notes

(1) $T_{amb} = 25\text{ °C}$, unless otherwise specified.

Stresses in excess of the absolute maximum ratings can cause permanent damage to the device. Functional operation of the device is not implied at these or any other conditions in excess of those given in the operational sections of this document. Exposure to absolute maximum ratings for extended periods of the time can adversely affect reliability.

(2) Refer to reflow profile for soldering conditions for surface mounted devices (SMD). Refer to wave profile for soldering conditions for through hole devices (DIP).



Optocoupler, Phototriac Output, Zero Crossing,
High dV/dt, Low Input Current

ELECTRICAL CHARACTERISTICS							
PARAMETER	TEST CONDITION	PART	SYMBOL	MIN.	TYP.	MAX.	UNIT
INPUT							
Forward voltage	$I_F = 10 \text{ mA}$		V_F		1.16	1.35	V
Reverse current	$V_R = 6.0 \text{ V}$		I_R		0.1	10	μA
Input capacitance	$V_F = 0 \text{ V}, f = 1.0 \text{ MHz}$		C_{IN}		25		pF
Thermal resistance, junction to ambient			R_{thja}		750		$^{\circ}\text{C/W}$
OUTPUT							
Off-state voltage	$I_{D(RMS)} = 70 \mu\text{A}$	IL410	$V_{D(RMS)}$	424	460		V
		IL4108	$V_{D(RMS)}$	565			V
Repetitive peak off-state voltage	$I_{DRM} = 100 \mu\text{A}$	IL410	V_{DRM}	600			V
		IL4108	V_{DRM}	800			V
Off-state current	$V_D = V_{DRM}, T_{amb} = 100 \text{ }^{\circ}\text{C}, I_F = 0 \text{ mA}$		$I_{D(RMS)1}$		10	100	μA
	$V_D = V_{DRM}, I_F = \text{Rated } I_{FT}$		$I_{D(RMS)2}$			200	μA
On-state voltage	$I_T = 300 \text{ mA}$		V_{TM}		1.7	3.0	V
On-state current	$\text{PF} = 1.0, V_{T(RMS)} = 1.7 \text{ V}$		I_{TM}			300	mA
Surge (non-repetitive), on-state current	$f = 50 \text{ Hz}$		I_{TSM}			3.0	A
Trigger current 1	$V_D = 5.0 \text{ V}$		I_{FT1}			2.0	mA
Trigger current 2	$V_{OP} = 220 \text{ V}, f = 50 \text{ Hz}, T_j = 100 \text{ }^{\circ}\text{C}, t_{pF} > 10 \text{ ms}$		I_{FT2}			6.0	mA
Trigger current temp. gradient			$\Delta I_{FT1}/\Delta T_j$		7.0	14	$\mu\text{A}/^{\circ}\text{C}$
			$\Delta I_{FT2}/\Delta T_j$		7.0	14	$\mu\text{A}/^{\circ}\text{C}$
Inhibit voltage temp. gradient			$\Delta V_{DINH}/\Delta T_j$		- 20		$\text{mV}/^{\circ}\text{C}$
Off-state current in inhibit state	$I_F = I_{FT1}, V_{DRM}$		I_{DINH}		50	200	μA
Holding current			I_H		65	500	μA
Latching current	$V_T = 2.2 \text{ V}$		I_L		5.0		mA
Zero cross inhibit voltage	$I_F = \text{Rated } I_{FT}$		V_{IH}		15	25	V
Turn-on time	$V_{RM} = V_{DM} = V_{D(RMS)}$		t_{on}		35		μs
Turn-off time	$\text{PF} = 1.0, I_T = 300 \text{ mA}$		t_{off}		50		μs
Critical rate of rise of off-state voltage	$V_D = 0.67 V_{DRM}, T_j = 25 \text{ }^{\circ}\text{C}$		dV/dt_{cr}	10000			$\text{V}/\mu\text{s}$
	$V_D = 0.67 V_{DRM}, T_j = 80 \text{ }^{\circ}\text{C}$		dV_{crq}/dt	5000			$\text{V}/\mu\text{s}$
Critical rate of rise of voltage at current commutation	$V_D = 0.67 V_{DRM}, dl/dt_{crq} \leq 15 \text{ A/ms}, T_j = 25 \text{ }^{\circ}\text{C}$		dV/dt_{crq}	10000			$\text{V}/\mu\text{s}$
	$V_D = 0.67 V_{DRM}, dl/dt_{crq} \leq 15 \text{ A/ms}, T_j = 80 \text{ }^{\circ}\text{C}$		dV/dt_{crq}	5000			$\text{V}/\mu\text{s}$
Critical rate of rise of on-state			dl/dt_{crq}	8.0			$\text{A}/\mu\text{s}$
Thermal resistance, junction to ambient			R_{thja}		150		$^{\circ}\text{C/W}$
COUPLER							
Critical rate of rise of coupled input/output voltage	$I_T = 0 \text{ A}, V_{RM} = V_{DM} = V_{D(RMS)}$		dV_{IO}/dt	10000			$\text{V}/\mu\text{s}$
Common mode coupling capacitance			C_{CM}		0.01		pF
Capacitance (input to output)	$f = 1.0 \text{ MHz}, V_{IO} = 0 \text{ V}$		C_{IO}		0.8		pF
Isolation resistance	$V_{IO} = 500 \text{ V}, T_{amb} = 25 \text{ }^{\circ}\text{C}$		R_{IO}		$\geq 10^{12}$		Ω
	$V_{IO} = 500 \text{ V}, T_{amb} = 100 \text{ }^{\circ}\text{C}$		R_{IO}		$\geq 10^{11}$		Ω

Note

$T_{amb} = 25 \text{ }^{\circ}\text{C}$, unless otherwise specified.

Minimum and maximum values are testing requirements. Typical values are characteristics of the device and are the result of engineering evaluation. Typical values are for information only and are not part of the testing requirements.

Vishay Semiconductors Optocoupler, Phototriac Output, Zero Crossing, High dV/dt, Low Input Current

POWER FACTOR CONSIDERATIONS

A snubber isn't needed to eliminate false operation of the TRIAC driver because of the IL410/IL4108's high static and commutating dV/dt with loads between 1.0 and 0.8 power factors. When inductive loads with power factors less than 0.8 are being driven, include a RC snubber or a single capacitor directly across the device to damp the peak commutating dV/dt spike. Normally a commutating dV/dt causes a turning-off device to stay on due to the stored energy remaining in the turning-off device.

But in the case of a zero voltage crossing optotriac, the commutating dV/dt spikes can inhibit one half of the TRIAC from turning on. If the spike potential exceeds the inhibit voltage of the zero cross detection circuit, half of the TRIAC will be held-off and not turn-on. This hold-off condition can be eliminated by using a snubber or capacitor placed directly across the optotriac as shown in Figure 1. Note that the value of the capacitor increases as a function of the load current.

The hold-off condition also can be eliminated by providing a higher level of LED drive current. The higher LED drive provides a larger photocurrent which causes the phototransistor to turn-on before the commutating spike has activated the zero cross network. Figure 2 shows the

relationship of the LED drive for power factors of less than 1.0. The curve shows that if a device requires 1.5 mA for a resistive load, then 1.8 times (2.7 mA) that amount would be required to control an inductive load whose power factor is less than 0.3.



Fig. 1 - Shunt Capacitance vs. Load Current

TYPICAL CHARACTERISTICS

T_{amb} = 25 °C, unless otherwise specified



Fig. 2 - Normalized LED Trigger Current vs. Power Factor



Fig. 3 - Forward Voltage vs. Forward Current

Optocoupler, Phototriac Output, Zero Crossing,
High dV/dt, Low Input Current

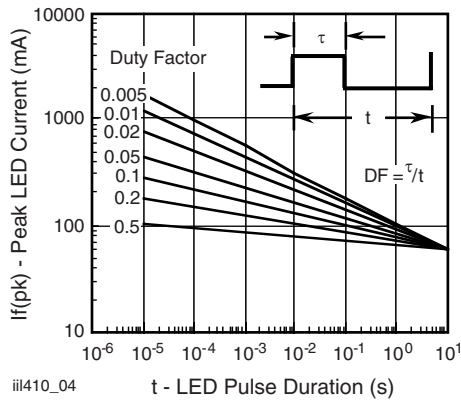

Fig. 4 - Peak LED Current vs. Duty Factor, τ

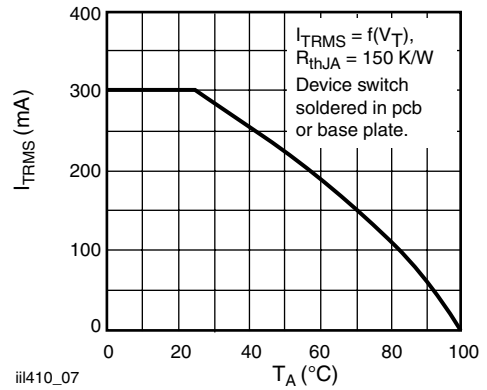

Fig. 7 - Current Reduction



Fig. 5 - Maximum LED Power Dissipation

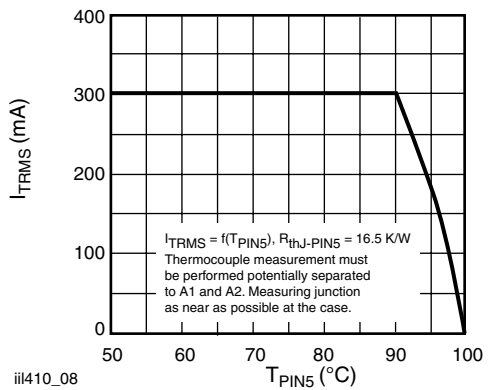

Fig. 8 - Current Reduction

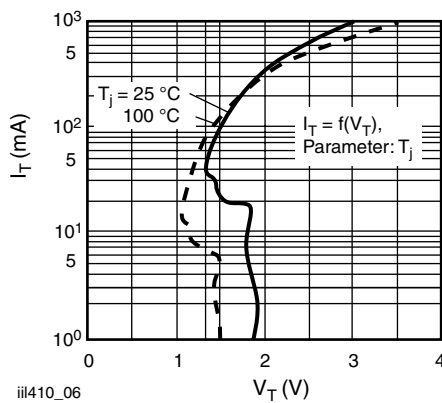

Fig. 6 - Typical Output Characteristics

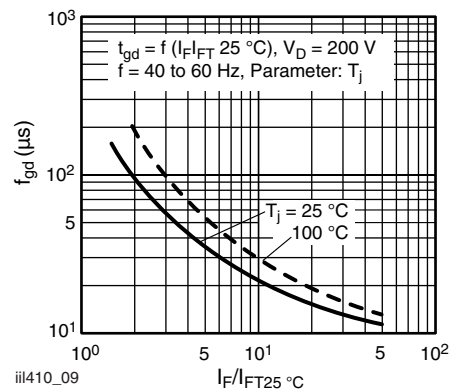

Fig. 9 - Typical Trigger Delay Time

Vishay Semiconductors Optocoupler, Phototriac Output, Zero Crossing,
High dV/dt, Low Input Current

TECHNICAL INFORMATION COMMUTATING BEHAVIOR

The use of a TRIAC at the output creates difficulties in commutation due to both the built-in coupled thyristor systems. The TRIAC can remain conducting by parasitic triggering after turning off the control current. However, if the IL410/4108 is equipped with two separate thyristor chips featuring high dV/dt strength, no RC circuit is needed in case of commutation.

CURRENT COMMUTATION:

The values 100 A/ms with following peak reverse recovery current > 80 mA should not be exceeded.

AVOIDING HIGH-FREQUENCY TURN-OFF CURRENT OSCILLATIONS:

This effect can occur when switching a circuit. Current oscillations which appear essentially with inductive loads of a higher winding capacity result in current commutation and can generate a relatively high peak reverse recovery current. The following alternating protective measures are recommended for the individual operating states:



Fig. 10 - Typical Inhibit Current



Fig. 11 - Power Dissipation 40 to 60 Hz Line Operation

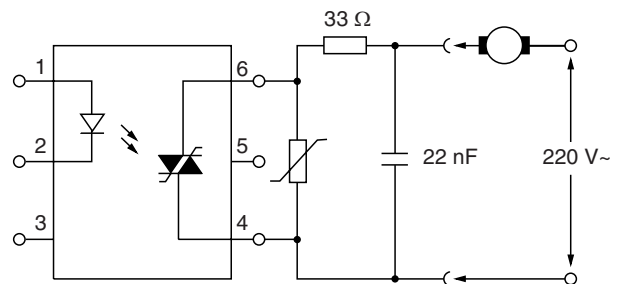

Fig. 12 - Typical Static Inhibit Voltage Limit



iii410_13

Fig. 13 - 1 - Apply a Capacitor to the Supply Pins at the Load-Side



iii410_14

Fig. 14 - 2 - Connect a Series Resistor to the Output and Bridge Both by a Capacitor

Optocoupler, Phototriac Output, Zero Crossing,
High dV/dt, Low Input Current

Vishay Semiconductors

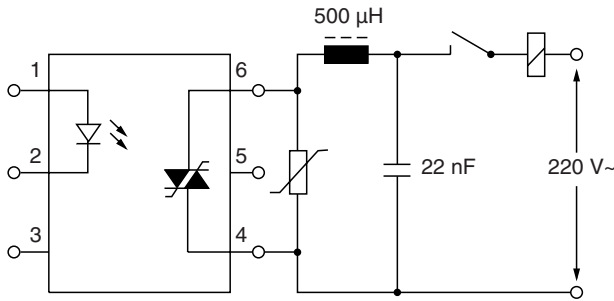

iii410_15

Fig. 15 - 3 - Connect a Choke of Low Winding Cap. in Series, e.g., a Ringcore Choke, with Higher Load Currents

Note

Measures 2 to 3 are especially required for the load separated from the IL410/IL4108 during operation. The above mentioned effects do not occur with IL410/IL4108 circuits which are connected to the line by transformers and which are not mechanically interrupted. In such cases as well as in applications with a resistive load the corresponding protective circuits can be neglected.

CONTROL AND TURN-ON BEHAVIOR

The trigger current of the IL410/IL4108 has a positive temperature gradient. The time which expires from applying the control current to the turn-on of the load current is defined as the trigger delay time (t_{gd}). On the whole this is a function of the overdrive meaning the ratio of the applied control current versus the trigger current (I_F/I_{FT}). If the value of the control current corresponds to that of the individual trigger current of IL410/4108 turn-on delay times amounts to a few milliseconds only. The shortest times of 5.0 to 10 ms can be achieved for an overdrive greater or equal than 10. The trigger delay time rises with an increase in temperature.

For very short control current pulses ($t_{pIF} < 500 \mu s$) a correspondingly higher control current must be used. Only the IL410/IL4108 without zero voltage switch is suitable for this operating mode.

ZERO VOLTAGE SWITCH

The IL410/IL4108 with zero voltage switch can only be triggered during the zero crossing the sine AC voltage. This prevents current spikes, e.g. when turning-on cold lamps or capacitive loads.

APPLICATIONS

Direct switching operation: The IL410/IL4108 switch is mainly suited to control synchronous motors, valves, relays and solenoids in Grätz circuits. Due to the low latching current (500 µA) and the lack of an RC circuit at the output, very low load currents can easily be switched.

Indirect switching operation: The IL410/IL4108 switch acts

here as a driver and thus enables the driving of thyristors and triacs of higher performance by microprocessors. The driving current pulse should not exceed the maximum permissible surge current of the IL410/IL4108. For this reason, the IL410/IL4108 without zero voltage switch often requires current limiting by a series resistor.

The favorably low latching current in this operating mode results in AC current switches which can handle load currents from some milliamperes up to high currents.

APPLICATION NOTE

Over voltage protection: A voltage-limiting varistor (e.g. SIO VS05K250) which directly connected to the IL410/IL4108 can protect the component against overvoltage.

IL410/IL4108



Vishay Semiconductors Optocoupler, Phototriac Output, Zero Crossing,

High dV/dt, Low Input Current

PACKAGE DIMENSIONS in inches (millimeters)

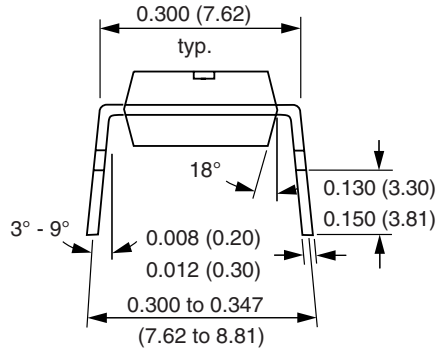
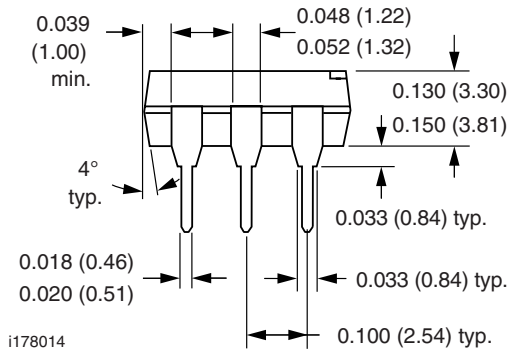
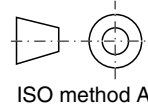

Option 6

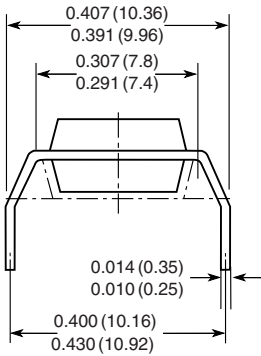

Option 7

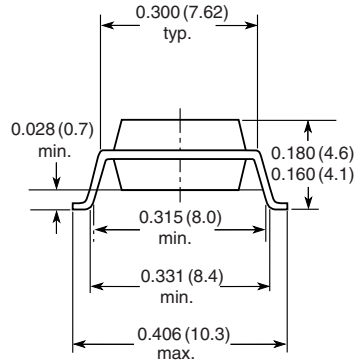

Option 9



18450



Optocoupler, Phototriac Output, Zero Crossing,
High dV/dt, Low Input Current

OZONE DEPLETING SUBSTANCES POLICY STATEMENT

It is the policy of Vishay Semiconductor GmbH to

1. Meet all present and future national and international statutory requirements.
2. Regularly and continuously improve the performance of our products, processes, distribution and operating systems with respect to their impact on the health and safety of our employees and the public, as well as their impact on the environment.

It is particular concern to control or eliminate releases of those substances into the atmosphere which are known as ozone depleting substances (ODSs).

The Montreal Protocol (1987) and its London Amendments (1990) intend to severely restrict the use of ODSs and forbid their use within the next ten years. Various national and international initiatives are pressing for an earlier ban on these substances.

Vishay Semiconductor GmbH has been able to use its policy of continuous improvements to eliminate the use of ODSs listed in the following documents.

1. Annex A, B and list of transitional substances of the Montreal Protocol and the London Amendments respectively.
2. Class I and II ozone depleting substances in the Clean Air Act Amendments of 1990 by the Environmental Protection Agency (EPA) in the USA.
3. Council Decision 88/540/EEC and 91/690/EEC Annex A, B and C (transitional substances) respectively.

Vishay Semiconductor GmbH can certify that our semiconductors are not manufactured with ozone depleting substances and do not contain such substances.

We reserve the right to make changes to improve technical design
and may do so without further notice.

Parameters can vary in different applications. All operating parameters must be validated for each customer application by the customer. Should the buyer use Vishay Semiconductors products for any unintended or unauthorized application, the buyer shall indemnify Vishay Semiconductors against all claims, costs, damages, and expenses, arising out of, directly or indirectly, any claim of personal damage, injury or death associated with such unintended or unauthorized use.

Vishay Semiconductor GmbH, P.O.B. 3535, D-74025 Heilbronn, Germany



Disclaimer

All product specifications and data are subject to change without notice.

Vishay Intertechnology, Inc., its affiliates, agents, and employees, and all persons acting on its or their behalf (collectively, "Vishay"), disclaim any and all liability for any errors, inaccuracies or incompleteness contained herein or in any other disclosure relating to any product.

Vishay disclaims any and all liability arising out of the use or application of any product described herein or of any information provided herein to the maximum extent permitted by law. The product specifications do not expand or otherwise modify Vishay's terms and conditions of purchase, including but not limited to the warranty expressed therein, which apply to these products.

No license, express or implied, by estoppel or otherwise, to any intellectual property rights is granted by this document or by any conduct of Vishay.

The products shown herein are not designed for use in medical, life-saving, or life-sustaining applications unless otherwise expressly indicated. Customers using or selling Vishay products not expressly indicated for use in such applications do so entirely at their own risk and agree to fully indemnify Vishay for any damages arising or resulting from such use or sale. Please contact authorized Vishay personnel to obtain written terms and conditions regarding products designed for such applications.

Product names and markings noted herein may be trademarks of their respective owners.

Компания «Life Electronics» занимается поставками электронных компонентов импортного и отечественного производства от производителей и со складов крупных дистрибьюторов Европы, Америки и Азии.

С конца 2013 года компания активно расширяет линейку поставок компонентов по направлению коаксиальный кабель, кварцевые генераторы и конденсаторы (керамические, пленочные, электролитические), за счёт заключения дистрибьюторских договоров

Мы предлагаем:

- Конкурентоспособные цены и скидки постоянным клиентам.
- Специальные условия для постоянных клиентов.
- Подбор аналогов.
- Поставку компонентов в любых объемах, удовлетворяющих вашим потребностям.
- Приемлемые сроки поставки, возможна ускоренная поставка.
- Доставку товара в любую точку России и стран СНГ.
- Комплексную поставку.
- Работу по проектам и поставку образцов.
- Формирование склада под заказчика.
- Сертификаты соответствия на поставляемую продукцию (по желанию клиента).
- Тестирование поставляемой продукции.
- Поставку компонентов, требующих военную и космическую приемку.
- Входной контроль качества.
- Наличие сертификата ISO.

В составе нашей компании организован Конструкторский отдел, призванный помогать разработчикам, и инженерам.

Конструкторский отдел помогает осуществить:

- Регистрацию проекта у производителя компонентов.
- Техническую поддержку проекта.
- Защиту от снятия компонента с производства.
- Оценку стоимости проекта по компонентам.
- Изготовление тестовой платы монтаж и пусконаладочные работы.



Тел: +7 (812) 336 43 04 (многоканальный)
Email: org@lifeelectronics.ru