

# Analog Devices Welcomes Hittite Microwave Corporation

NO CONTENT ON THE ATTACHED DOCUMENT HAS CHANGED



**THIS PAGE INTENTIONALLY LEFT BLANK**

## GaAs pHEMT MMIC LOW NOISE HIGH IP3 AMPLIFIER, 12 - 16 GHz

### Typical Applications

The HMC490LP5(E) is ideal for:

- Point-to-Point Radios
- Point-to-Multi-Point Radios
- VSAT
- Military EW, ECM & C<sup>3</sup>I

### Features

- Noise Figure: 2.5 dB
- P1dB Output Power: +25 dBm
- Gain: 23 dB
- Output IP3: +34 dBm
- +5V Supply
- 50 Ohm Matched Input/Output
- 32 Lead 5x5mm SMT Package: 25mm<sup>2</sup>

### Functional Diagram

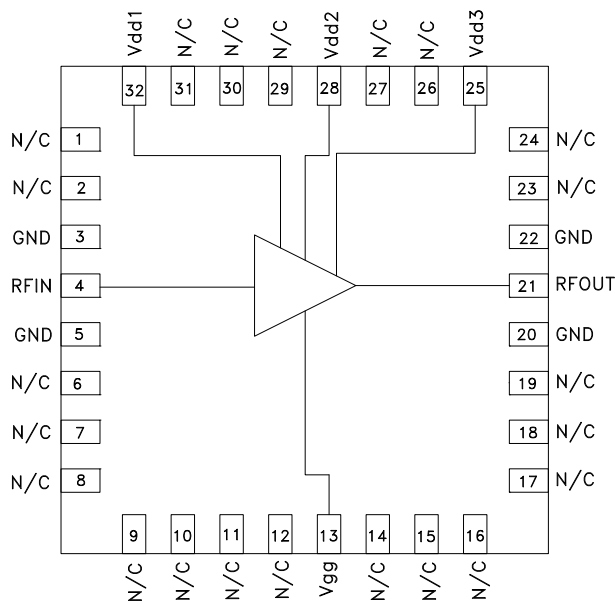

### General Description

The HMC490LP5(E) is a high dynamic range GaAs pHEMT MMIC Low Noise Amplifier which operates between 12 and 16 GHz. The HMC490LP5(E) provides 23 dB of gain, 2.5 dB noise figure and an output IP3 of +34 dBm from a +5V supply voltage. This versatile amplifier combines excellent, stable +25 dBm P1dB output power with very low noise figure making it ideal for receive and transmit applications. The amplifier is packaged in a leadless 5x5 mm QFN surface mount package.

### Electrical Specifications, $T_A = +25^\circ\text{C}$ , $V_{dd} = 5\text{V}$ , $I_{dd} = 200\text{mA}^*$

Parameter	Min.	Typ.	Max.	Units
Frequency Range	12 - 16			GHz
Gain	20	23		dB
Gain Variation Over Temperature		0.03	0.04	dB/°C
Noise Figure		2.5	3.5	dB
Input Return Loss		8		dB
Output Return Loss		8		dB
Output Power for 1 dB Compression (P1dB)	22	25		dBm
Saturated Output Power (P <sub>sat</sub> )		27		dBm
Output Third Order Intercept (IP3)		34		dBm
Supply Current (I <sub>dd</sub> )(V <sub>dd</sub> = 5V, V <sub>gg</sub> = -0.8V Typ.)		200		mA

\* Adjust V<sub>gg</sub> between -2 to 0V to achieve I<sub>dd</sub> = 200 mA typical.

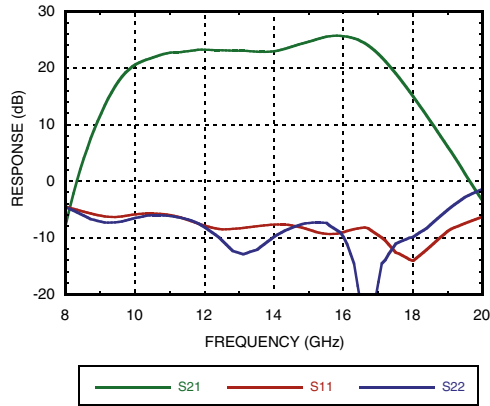
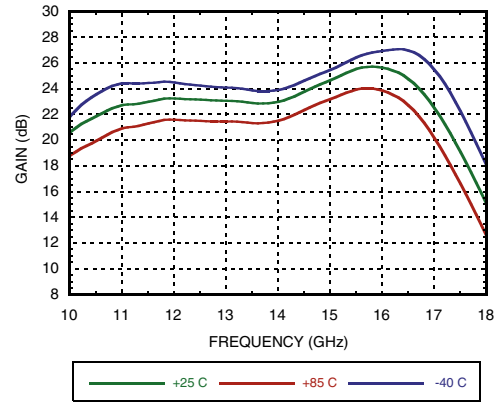
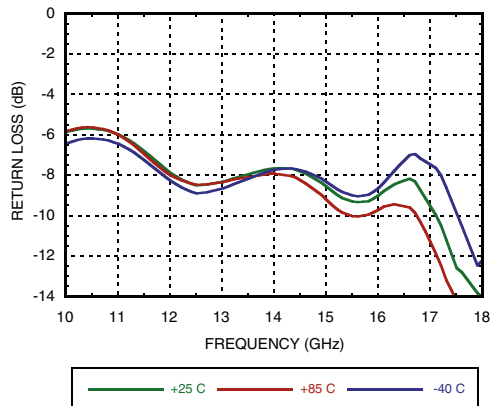
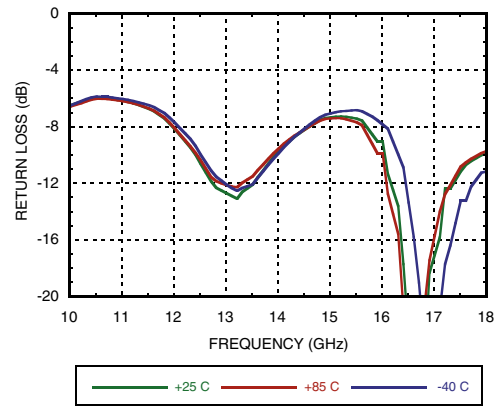
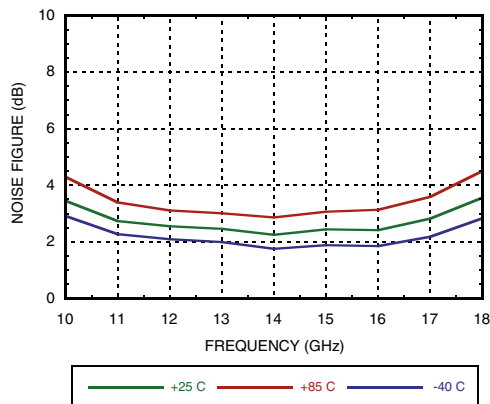
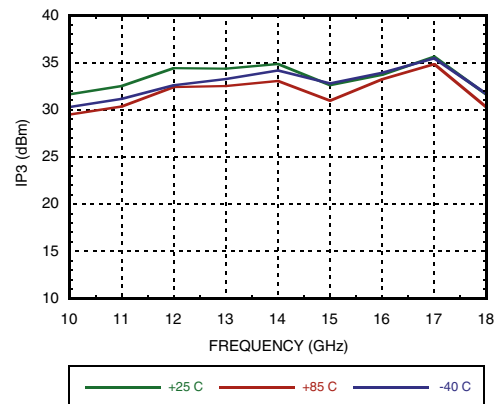
**Broadband Gain & Return Loss**

**Gain vs. Temperature**

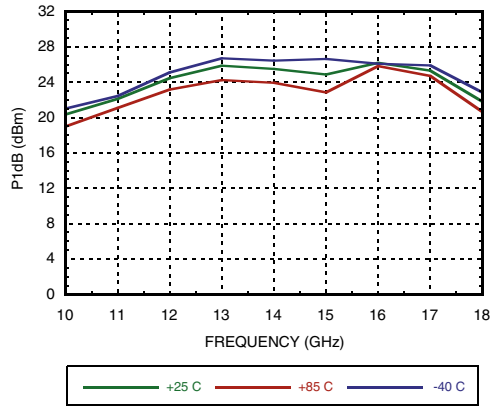
**Input Return Loss vs. Temperature**

**Output Return Loss vs. Temperature**

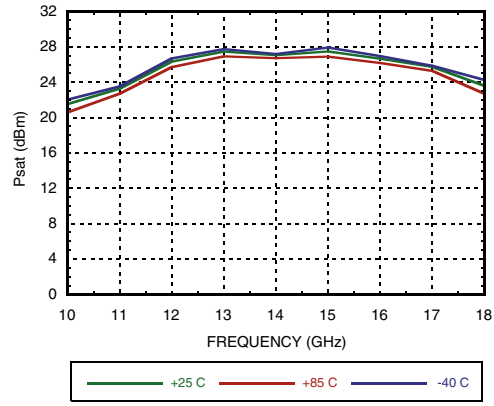
**Noise Figure vs. Temperature**

**Output IP3 vs. Temperature**

**P1dB vs. Temperature**



**Psat vs. Temperature**



**Gain, Noise Figure & OIP3 vs. Supply Voltage @ 14 GHz, I<sub>dd</sub>= 200 mA**

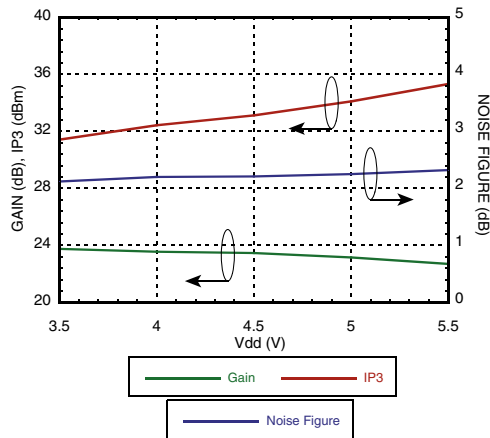

**Power Compression @ 14 GHz**

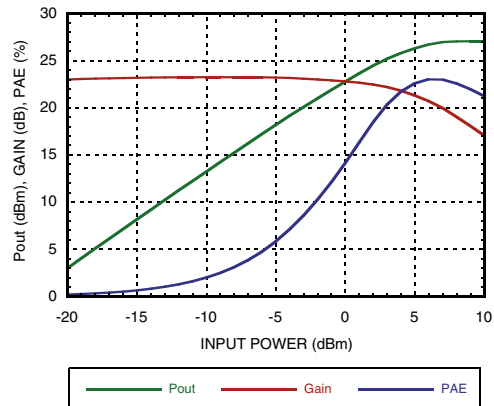

**Gain, Noise Figure & IP3 vs. Supply Current @ 14 GHz, V<sub>dd</sub>= 5V\***

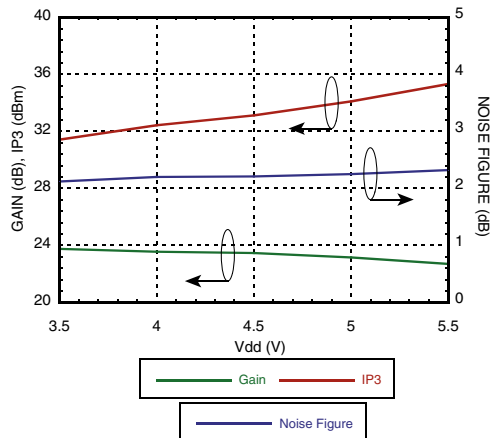

**Power Dissipation**

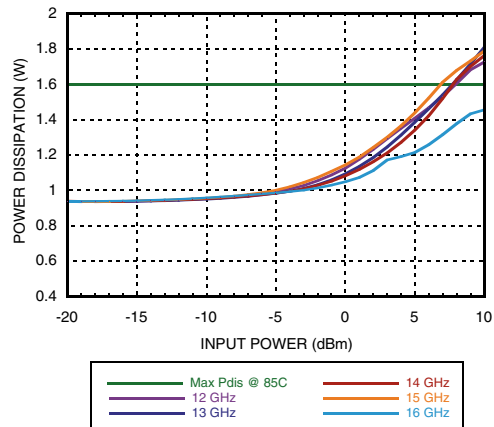

\* I<sub>dd</sub> is controlled by varying V<sub>gg</sub>

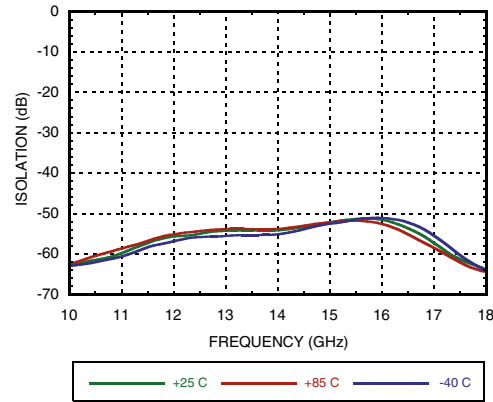
**Reverse Isolation vs. Temperature**

**Absolute Maximum Ratings**

Drain Bias Voltage (Vdd1, Vdd2, Vdd3)	+5.5V
Gate Bias Voltage (Vgg)	-4 to 0V
RF Input Power (RFIN)(Vdd = +5V)	+10 dBm
Channel Temperature	175 °C
Continuous P <sub>diss</sub> (T = 85 °C) (derate 17.9 mW/°C above 85 °C)	1.6 W
Thermal Resistance (channel to ground paddle)	56 °C/W
Storage Temperature	-65 to +150 °C
Operating Temperature	-40 to +85 °C

**Typical Supply Current vs. Vdd**

Vdd (V)	I <sub>dd</sub> (mA)
+3.0	140
+3.5	154
+4.0	168
+4.5	188
+5.0	200
+5.5	208

Note: Amplifier will operate over full voltage ranges shown above.

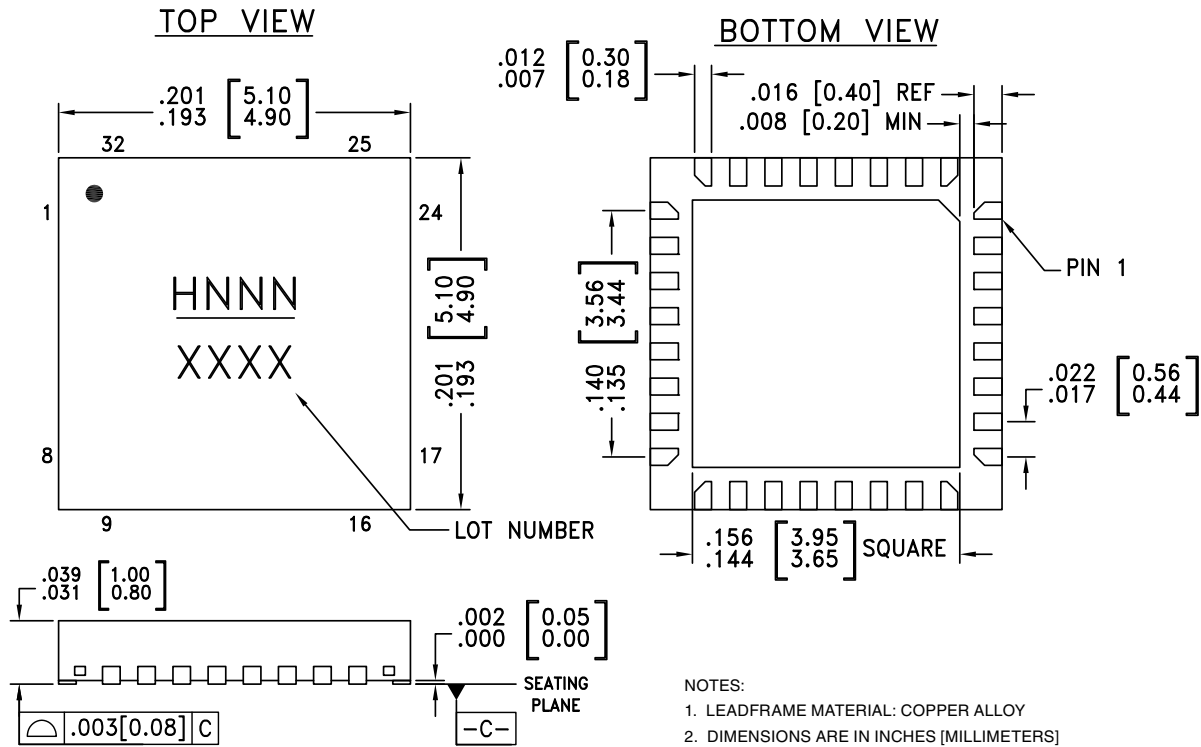

**ELECTROSTATIC SENSITIVE DEVICE  
OBSERVE HANDLING PRECAUTIONS**

**Outline Drawing**

**Package Information**

Part Number	Package Body Material	Lead Finish	MSL Rating	Package Marking <sup>[3]</sup>
HMC490LP5	Low Stress Injection Molded Plastic	Sn/Pb Solder	MSL1 <sup>[1]</sup>	H490 XXXX
HMC490LP5E	RoHS-compliant Low Stress Injection Molded Plastic	100% matte Sn	MSL1 <sup>[2]</sup>	H490 XXXX

[1] Max peak reflow temperature of 235 °C

[2] Max peak reflow temperature of 260 °C

[3] 4-Digit lot number XXXX

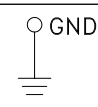
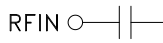
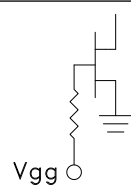
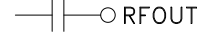

### Pin Descriptions

Pin Number	Function	Description	Interface Schematic
1, 2, 6 - 12, 14 - 19, 23, 24, 26, 27, 29 - 31	N/C	The pins are not connected internally; however, all data shown herein was measured with these pins connected to RF/DC ground externally.	
3, 5, 20, 22	GND	Package bottom must also be connected to RF/DC ground.	
4	RFIN	This pad is AC coupled and matched to 50 Ohms.	
13	Vgg	Gate control for amplifier. Adjust to achieve I <sub>dd</sub> of 200 mA. Please follow "MMIC Amplifier Biasing Procedure" Application Note. External bypass capacitors of 100 pF and 0.01 μF are required.	
21	RFOUT	This pad is AC coupled and matched to 50 Ohms.	
25, 28, 32	Vdd3, 2, 1	Power Supply Voltage for the amplifier. External bypass capacitors of 100 pF and 0.01 μF are required.	

### Application Circuit

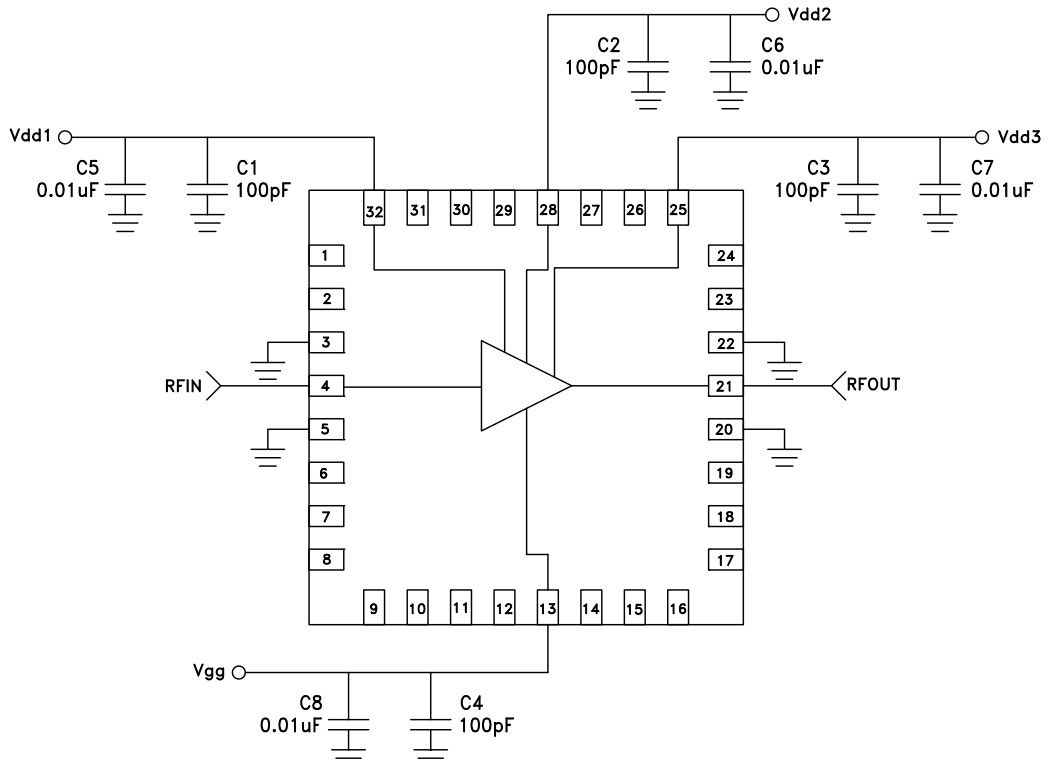



### Evaluation PCB

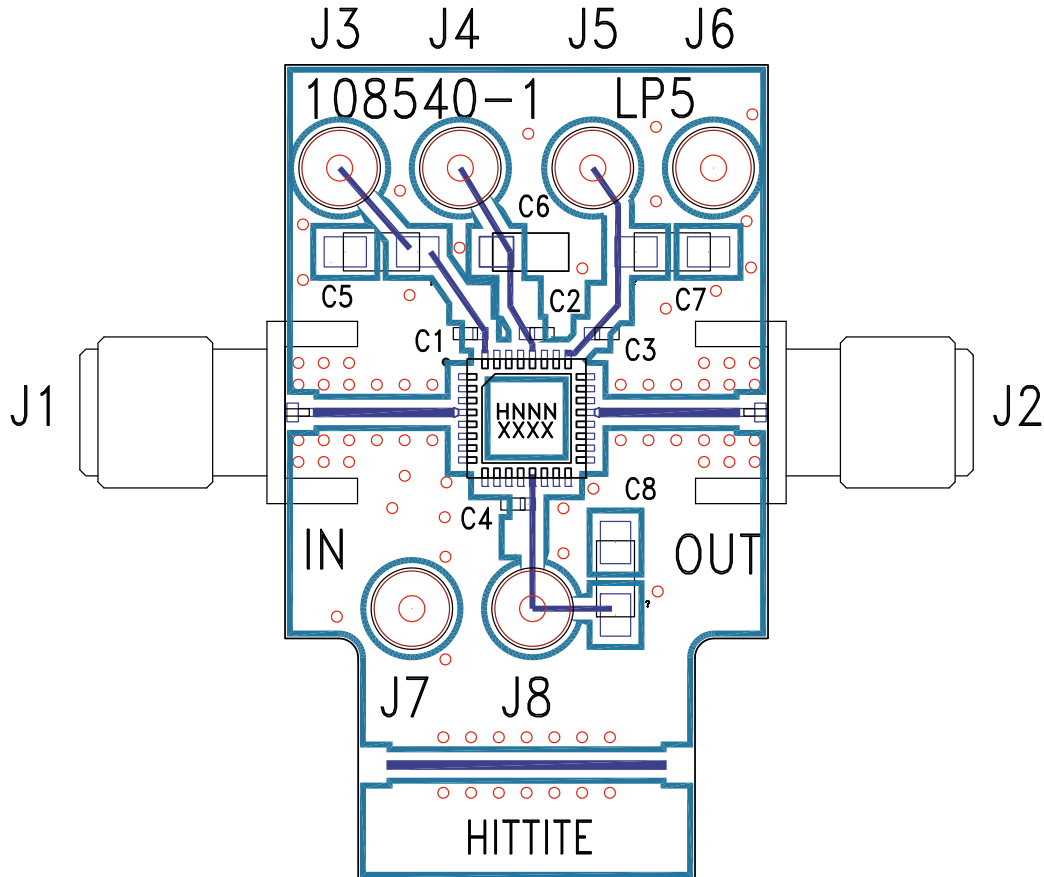

### List of Materials for Evaluation PCB 108402 [1]

Item	Description
J1 - J2	PCB Mount SMA Connector
J3 - J8	DC Pin
C1 - C4	1000 pF Capacitor, 0402 Pkg.
C5 - C8	4.7 μF Capacitor, Tantalum
U1	HMC490LP5 / HMC490LP5E
PCB [2]	108540 Evaluation PCB

[1] Reference this number when ordering complete evaluation PCB

[2] Circuit Board Material: Rogers 4350

The circuit board used in the application should use RF circuit design techniques. Signal lines should have 50 Ohm impedance while the package ground leads and package bottom should be connected directly to the ground plane similar to that shown. A sufficient number of via holes should be used to connect the top and bottom ground planes. The evaluation board should be mounted to an appropriate heat sink. The evaluation circuit board shown is available from Hittite upon request.



## HMC490LP5 / 490LP5E

**GaAs pHEMT MMIC LOW NOISE  
HIGH IP3 AMPLIFIER, 12 - 16 GHz**

**Notes:**

Компания «Life Electronics» занимается поставками электронных компонентов импортного и отечественного производства от производителей и со складов крупных дистрибьюторов Европы, Америки и Азии.

С конца 2013 года компания активно расширяет линейку поставок компонентов по направлению коаксиальный кабель, кварцевые генераторы и конденсаторы (керамические, пленочные, электролитические), за счёт заключения дистрибьюторских договоров

Мы предлагаем:

- Конкурентоспособные цены и скидки постоянным клиентам.
- Специальные условия для постоянных клиентов.
- Подбор аналогов.
- Поставку компонентов в любых объемах, удовлетворяющих вашим потребностям.
- Приемлемые сроки поставки, возможна ускоренная поставка.
- Доставку товара в любую точку России и стран СНГ.
- Комплексную поставку.
- Работу по проектам и поставку образцов.
- Формирование склада под заказчика.
- Сертификаты соответствия на поставляемую продукцию (по желанию клиента).
- Тестирование поставляемой продукции.
- Поставку компонентов, требующих военную и космическую приемку.
- Входной контроль качества.
- Наличие сертификата ISO.

В составе нашей компании организован Конструкторский отдел, призванный помогать разработчикам, и инженерам.

Конструкторский отдел помогает осуществить:

- Регистрацию проекта у производителя компонентов.
- Техническую поддержку проекта.
- Защиту от снятия компонента с производства.
- Оценку стоимости проекта по компонентам.
- Изготовление тестовой платы монтаж и пусконаладочные работы.



Тел: +7 (812) 336 43 04 (многоканальный)

Email: [org@lifeelectronics.ru](mailto:org@lifeelectronics.ru)