

Multifunction Counter/Tachometer H7CX-□-N

Ultra-compact Counter Provides More Complete Functionality.



Basic Features

- Short body with depth of only 59 mm (for 12 to 24-VDC Models with Screw Terminals).^{*1}
- Better readability with character height of 12 mm on 4-digit models and 10 mm on 6-digit models.
- The present value display characters can be switched between red, green, and orange.^{*2}

Safety and Reliability

- New set value limit and counter functions have been added.

Other Features

- Front Panel can be changed to white or light gray.^{*3}
- New models with two tachometer inputs and two tachometer outputs have been added to the series.^{*4}

*1. For 100 to 240-VAC Models with Screw Terminals: 78 mm, Models with Sockets: 63.7 mm (case dimension).

*2. The H7CX-A11 and H7CX-R11 have only red characters.

*3. The Front Panel can be replaced with an optional Front Panel (except for Tachometer-only Models).

*4. Only one prescale value provided.



For the most recent information on models that have been certified for safety standards, refer to your OMRON website.

Refer to **Safety Precautions** on page 52.

Features

Basic Features

Ultra Short Body

The body depth has been greatly reduced. Helps in making thinner control panels.

- 12 to 24-VDC Models with Screw Terminals: 59 mm
- 100 to 240-VAC Models with Screw Terminals: 78 mm*
- Models with Sockets: 63.7 mm (case dimension)

* Power supply circuit and input circuits are isolated for safety and reliability.

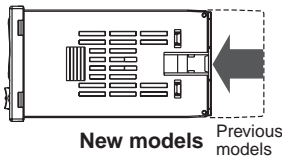

Easier to Read

For better readability, the character height for the present value display is 12 mm on models with 4 digits, the largest class in the industry. The wide viewing angle and brightness provide excellent visibility. The number of display segments has also been increased to make settings easier to understand, and the present value display can be switched between red, green, and orange so that output status can be seen from a distance.

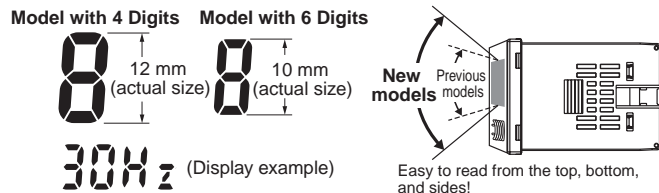

Note: The display color can be switched on all models except for the H7CX-A11 and H7CX-R11.

The Easiest Operation

Operation is simplified by the Up/Down Key for each digit on 4-digit models and Up Key for each digit on 6-digit models.

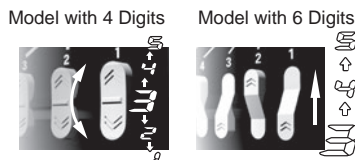

Safety and Reliability

Isolated Power Supply and Input Circuits

Power supply circuit and input circuits are isolated inside the Counter/Tachometer. Previous non-isolated counters had wiring restrictions and could be damaged if wired incorrectly. The H7CX removes these worries.

Note: Except 12 to 24-VDC models.

Set Value Limit

You can set an upper limit for the set value to prevent unexpected operation of output devices caused by setting mistakes.

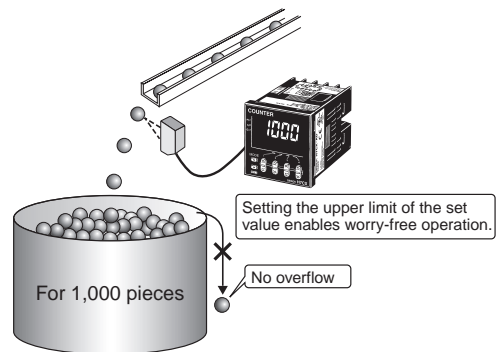

Output Counter

The output counter counts the number of times the output turns ON (alarms can be displayed and the count can be monitored in increments of 1,000 operations). This counter is useful in managing the service life of the Counter/Tachometer or the load.

Other Features

The front color can be changed simply by replacing the Front Panel.

The Front Panel can be replaced with an optional Front Panel (sold separately) with a different color to match the installation site. Select from black, white, and light gray (except for models with tachometer function only).

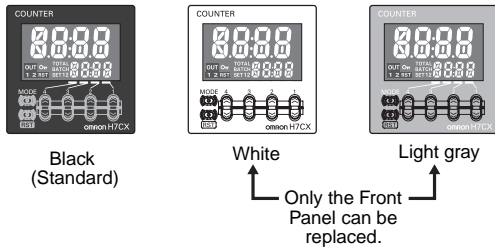

Universal NPN/PNP Input

DC 2-wire sensors can be connected for a wide range of input devices.

Waterproof, Dust-proof Structure (UL508 Type 4X and IP66)

Worry-free application is possible in locations subject to water.

Note: When the Y92S-29 Waterproof Packing is used.

Model Number Structure

Model Configuration

H7CX Series						
		H7CX-A-series Multifunction Preset Counter			H7CX-R-series Digital Tachometer	
Model						
Classification		Preset counter		Preset counter/tachometer	Tachometer	
Model		H7CX-A□-N	H7CX-A4W□-N	H7CX-AW□-N/AU□-N	H7CX-R11□-N	H7CX-R11W□-N
Function	1-stage preset counter	Yes	Yes	Yes	No	
	2-stage preset counter	No	Yes	Yes	No	
	Total and preset counter	Yes	Yes	Yes	No	
	Batch counter	No	Yes	Yes	No	
	Dual counter	No	Yes	Yes	No	
	Twin counter	No	Yes	Yes	No	
	Tachometer	No	No	Yes*1	Yes	
Tachometer input		No	No	Yes 1 input or 2 inputs (independent measurements, differential, absolute ratio value, and error ratio value)	Yes 1 input	Yes 2 inputs (independent measurement) only
Settings		1-stage		2-stage	1-stage	
External connections		11-pin socket	Screw terminals			11-pin socket
Display color of present value		Red	Red, green, or orange			Red
Display digits		4 or 6 digits		4 digits	6 digits	6 digits

*1. Set the tachometer input mode from the function setting mode to switch to the tachometer function.

Key Protection

Select from any of seven protection patterns. Use the best one for the application.

New Functions

Many useful functions have been added, including a Twin Counter Mode and many tachometer functions to handle even more applications.

New Tachometer Functions

- Control with two independent inputs (independent measurements, differential, absolute ratio, and error ratio)
- Peak/bottom hold function
- Output hysteresis setting
- Output OFF delay
- Switching the measurement method (pulse cycle/pulse width)
- Startup time
- Auto-zero time
- Averaging method/Number of averaging times
- AMD-compatible Mode

Note: Refer to "Model Configuration" below, for details on applicable functions.

Model Number Legend (Not all possible combinations of functions are available.)

H7CX-□□□□□□-N
1 2 3 4 5 6

1. Type

Symbol	Meaning
A	Standard type
R	Tachometer

4. Settings

Symbol	Meaning
None	1-stage setting
U	Factory-set to 1-stage setting
W	Factory-set to 2-stage setting*

* The H7CX-R11W□ is a 1-stage (2 inputs and outputs) rather than a 2-stage Counter.

2. External connections

Symbol	Meaning
None	Screw terminals
11	11-pin socket

5. Output type

Symbol	Meaning
None	Contact output or contact output + transistor output
S	Transistor output

3. Digits

Symbol	Meaning
None	6 digits
4	4 digits

6. Supply voltage

Symbol	Meaning
None	100 to 240 VAC at 50/60 Hz
D	12 to 24 VDC
D1	12 to 24 VDC/24 VAC at 50/60 Hz

Note: Estimates can be provided for coatings and other specifications that are not given in the datasheet. Ask your OMRON representative for details.

Ordering Information

List of Models

Type	Classification	Configuration	External connections	Settings	Display digits	Outputs	Power supply voltage	Model		
H7CX-A Series	Preset counter	<ul style="list-style-type: none"> 1-stage preset counter Total and preset counter 	11-pin socket	1-stage	4 digits	Contact output (SPDT)	100 to 240 VAC	H7CX-A114-N		
						Transistor output (SPST)		H7CX-A114S-N		
					6 digits	Contact output (SPDT)	12 to 24 VDC/24 VAC	H7CX-A114D1-N		
						Transistor output (SPST)		100 to 240 VAC	H7CX-A11-N	
						Contact output (SPDT)		12 to 24 VDC/24 VAC	H7CX-A11S-N	
			4 digits		Transistor output (SPST)	100 to 240 VAC	H7CX-A11D1-N			
					Contact output (SPDT)	12 to 24 VDC	H7CX-A11SD1-N			
			Screw terminals		<ul style="list-style-type: none"> 1-stage preset counter 2-stage preset counter Total and preset counter Batch counter Dual counter Twin counter 	1-stage	4 digits	Contact output (SPDT)	100 to 240 VAC	H7CX-A4-N
								Transistor output (SPST)		H7CX-A4S-N
							6 digits	Contact output (SPDT)	12 to 24 VDC	H7CX-A4D-N
	Transistor output (SPST)	100 to 240 VAC		H7CX-A4SD-N						
	Contact output (SPDT)	12 to 24 VDC		H7CX-A-N						
	Transistor output (SPST)	12 to 24 VDC	H7CX-AS-N							
	Preset counter/ Tachometer	<ul style="list-style-type: none"> 1-stage preset counter 2-stage preset counter Total and preset counter Batch counter Dual counter Twin counter Tachometer 	2-stage	4 digits	Contact output (SPST + SPDT)	100 to 240 VAC	H7CX-A4W-N			
					Transistor output (DPST)		12 to 24 VDC	H7CX-A4WSD-N		
				6 digits	Contact output (SPST + SPDT)	100 to 240 VAC	H7CX-AW-N			
					Transistor output (DPST)		H7CX-AWS-N			
					Contact output (SPST + SPDT)	12 to 24 VDC/24 VAC	H7CX-AWD1-N			
					Transistor output (DPST)		12 to 24 VDC	H7CX-AWSD1-N		
					Contact output (SPDT) + Transistor output (SPST)	100 to 240 VAC	H7CX-AU-N			
Contact output (SPDT) + Transistor output (SPST)					12 to 24 VDC/24 VAC	H7CX-AUD1-N				
Transistor output (DPST)				12 to 24 VDC/24 VAC	H7CX-AUSD1-N					
H7CX-R Series				Tachometer	<ul style="list-style-type: none"> Tachometer 	11-pin socket	1-stage (1 input and output)	6 digits	Contact output (SPDT)	100 to 240 VAC
	1-stage (2 inputs and outputs)	12 to 24 VDC/24 VAC	H7CX-R11D1-N							
	6 digits	Contact output (SPDT + SPST)	100 to 240 VAC			H7CX-R11W-N				
		Contact output (SPDT + SPST)	12 to 24 VDC/24 VAC			H7CX-R11WD1-N				

Note: 1. The functions that are provided depend on the model. Check detailed specifications before ordering.
2. Refer to page 37 and later for information on H7CX-R Tachometers.

Accessories (Order Separately)

Front Panels (Replacement Part)

Model	Color	Applicable Counters	Page
Y92P-CXC4G	Light gray (5Y7/1)	4-digit Counter	12
Y92P-CXC4S	White (5Y9.2/0.5)		
Y92P-CXC4B	Black (N1.5)		
Y92P-CXC6G	Light gray (5Y7/1)	6-digit Counter	
Y92P-CXC6S	White (5Y9.2/0.5)		
Y92P-CXC6B	Black (N1.5)		

Note: 1. You can change the color of the Front Panel when mounting the Counter. The Counter is shipped with a black (N1.5) Front Panel.
2. "COUNTER" is printed on the front of Replacement Front Panels.

Soft Cover

Model	Remarks	Page
Y92A-48F1	---	12

Hard Cover

Model	Remarks	Page
Y92A-48	---	12

Flush Mounting Adapter

Model	Remarks	Page
Y92F-30	Included with models with screw terminals.	12
Y92F-45	Use this Adapter to install the Counter/Tachometer in a cutout previously made for a DIN 72 × 72 mm device (panel cutout: 68 × 68 mm).	

Waterproof Packing

Model	Remarks	Page
Y92S-29	Included with models with screw terminals.	12

Connection Sockets

Model	Classification	Connectable Counter/Tachometers	Remarks	Page
P2CF-11	Front-connecting Socket	H7CX-□11□-N	---	13
P2CF-11-E	Front-connecting Socket (Finger-safe Type)		Round crimp terminals cannot be used on Finger-safe Sockets. Use forked crimp terminals.	
P3GA-11	Back-connecting Sockets		A Y92A-48G Terminal Cover can be used with the Socket to create a finger-safe construction.	

Terminal Covers for P3GA-11 Back-connecting Socket

Model	Remarks	Page
Y92A-48G	---	13



H7CX-A□-N Multifunction Preset Counter

- Easy to check the output status from a long distance with changing display colors*1 (red, green, and orange).
- Includes total and preset counter, batch counter, dual counter, twin counter, and tachometer.*2



*1. Not supported by the H7CX-A11□-N.
 *2. The functions that can be selected depend on the model.

For the most recent information on models that have been certified for safety standards, refer to your OMRON website.

Specifications

Ratings

Item	Models	H7CX-A114□-N	H7CX-A11□-N	H7CX-A4□-N	H7CX-A□-N	H7CX-A4W□-N	H7CX-AW□-N/AUC□-N
Classification	Preset counter						Preset counter/ tachometer
Configuration	1-stage preset counter, 1-stage preset counter with total counter (selectable)*1					1-stage/2-stage preset counter, total and preset counter*1, batch counter, dual counter, and twin counter (selectable)	1-stage/2-stage preset counter, total and preset counter*1, batch counter, twin counter, and tachometer (selectable)
Ratings	Power supply voltage*2	• 100 to 240 VAC, 50/60 Hz • 24 VAC, 50/60 Hz or 12 to 24 VDC		• 100 to 240 VAC, 50/60 Hz • 12 to 24 VDC		• 100 to 240 VAC at 50/60 Hz • 24 VAC at 50/60 Hz or 12 to 24 VDC • 12 to 24 VDC	
	Operating voltage fluctuation range	85% to 110% of rated supply voltage (12 to 24 VDC: 90% to 110%)					
	Power consumption	Approx. 9.4 VA at 100 to 240 VAC, Approx. 7.2 VA/4.7 W at 24 VAC/12 to 24 VDC, Approx. 3.7 W at 12 to 24 VDC					
Mounting method	Flush mounting or surface mounting			Flush mounting			
External connections	11-pin socket			Screw terminals			
Degree of protection	IEC IP66, UL508 Type 4X (indoors) for panel surface only and only when Y92S-29 Waterproof Packing is used.						
Input signals	CP1, CP2, reset, and total reset					CP1, CP2, reset 1, and reset 2	
Counter	Maximum counting speed	30 Hz (minimum pulse width: 16.7 ms) or 5 kHz (minimum pulse width: 0.1 ms) (selectable) (ON/OFF ratio 1:1)*3 *Common setting for CP1 and CP2					
	Input mode	Increment, decrement, increment/decrement (UP/DOWN A (command input), UP/DOWN B (individual inputs), or UP/DOWN C (quadrature inputs))					
	Output mode	N, F, C, R, K-1, P, Q, A, K-2, D, and L.				N, F, C, R, K-1, P, Q, A, K-2, D, L, and H.	
	One-shot output time	0.01 to 99.99 s					
	Reset system	External (minimum reset signal width: 1 ms or 20 ms, selectable), manual, and automatic reset (internal according to C, R, P, and Q mode operation)					
Tachometer	Refer to the separate table for tachometer function ratings.						
Prescaling function	Yes (0.001 to 9.999)	Yes (0.001 to 99.999)	Yes (0.001 to 9.999)	Yes (0.001 to 99.999)	Yes (0.001 to 9.999)	Yes (0.001 to 99.999)	
Decimal point adjustment	Yes (rightmost 3 digits)						
Sensor waiting time	290 ms max. (Control output is turned OFF and no input is accepted during sensor waiting time.)						
Input method	No-voltage inputs: ON impedance: 1 kΩ max. (Leakage current: 12 mA at 0 Ω) ON residual voltage: 3 V max. OFF impedance: 100 kΩ min. Voltage input: High (logic) level: 4.5 to 30 VDC Low (logic) level: 0 to 2 VDC (Input resistance: approx. 4.7 kΩ) No-voltage input/voltage input (selectable)						
External power supply	12 VDC (±10%), 100 mA (except for H7CX-A□D models) Refer to <i>Precautions for Correct Use</i> on page 53 for details.						
Control output	• Contact output: 3 A at 250 VAC/30 VDC, resistive load (cosφ=1), Minimum applied load: 10 mA at 5 VDC (failure level: P, reference value) • Transistor output: NPN open collector, 100 mA at 30 VDC, Residual voltage: 1.5 VDC max. (approx. 1 V), Leakage current: 0.1 mA max.						
Display*4	7-segment, negative transmissive LCD Character height Count value: 12 mm (red) Set value: 6 mm (green)	7-segment, negative transmissive LCD Character height Count value: 10 mm (red) Set value: 6 mm (green)	7-segment, negative transmissive LCD Character height Count value: 12 mm (red, green, or orange selectable) Set value: 6 mm (green)	7-segment, negative transmissive LCD Character height Count value: 10 mm (red, green, or orange selectable) Set value: 6 mm (green)	7-segment, negative transmissive LCD Character height Count value: 12 mm (red, green, or orange selectable) Set value: 6 mm (green)	7-segment, negative transmissive LCD Character height Count value: 10 mm (red, green, or orange selectable) Set value: 6 mm (green)	
Digits	4 digits -999 to 9999 (-3 digits to +4 digits)	6 digits -99999 to 999999 (-5 digits to +6 digits)	4 digits -999 to 9999 (-3 digits to +4 digits)	6 digits -99999 to 999999 (-5 digits to +6 digits)	4 digits -999 to 9999 (-3 digits to +4 digits)	6 digits -99999 to 999999 (-5 digits to +6 digits), tachometer: 0 to 999999	
Memory backup	EEPROM (overwrites: 100,000 times min.) that can store data for 10 years min.						
Operating temperature range	-10 to 55°C (-10 to 50°C if Counter/Tachometers are mounted side by side) (with no icing or condensation)						
Storage temperature range	-25 to 70°C (with no icing or condensation)						
Operating humidity range	25% to 85%						
Case color	Black (N1.5) (Optional Front Panels are available to change the Front Panel color to light gray or white.)						
Attachments	---			Flush mounting adapter, waterproof packing, terminal cover			Flush mounting adapter, waterproof packing, terminal cover, label for DIP switch settings

*1. 1-stage preset counter and total counter functionality.
 *2. Do not use the output from an inverter as the power supply. The ripple must be 20% maximum for DC power.
 *3. A response of 10 kHz (minimum pulse width: 0.05 ms) is possible if the response speed is 5 kHz and the 1-stage preset counter input mode is increment, decrement, or increment/decrement (command input).
 *4. The display is lit only when the power is ON. Nothing is displayed when power is OFF.

Tachometer Function Ratings

Model	H7CX-A114□-N H7CX-A11□-N H7CX-A4□-N H7CX-A□-N H7CX-A4W□-N	H7CX-AW□-N/AU□-N			
Item					
Input mode	No tachometer functionality	Selectable from independent measurements for 1 or 2 inputs, differential input for 2 inputs, absolute ratio for 2 inputs, and error ratio for 2 inputs.			
Pulse measurement method		Periodic measurement		Pulse width measurement	
Maximum counting speed		30 Hz (minimum pulse width: 16.7 ms)	1-input mode: 10 kHz (minimum pulse width: 0.05 ms) Other modes: 5 kHz (minimum pulse width: 0.1 ms)	30 Hz (minimum pulse width: 16.7 ms)	1-input mode: 10 kHz (minimum pulse width: 0.05 ms) Other modes: 5 kHz (minimum pulse width: 0.1 ms)
Minimum input signal width		---	---	30 ms ⁻¹	1-input mode: 0.2 ms Other modes: 0.4 ms*
Measuring ranges		0.001 to 30.00 Hz	1-input mode: 0.001 to 10 kHz, Other modes: 0.01 to 5 kHz	0.030 to 999999 s	1-input mode: 0.0002 to 99999 s Other modes: 0.0004 to 99999 s
Sampling period		200 ms min.	200 ms min. or continuous selectable (minimum interval of 10 ms)	Continuous (minimum interval of 10 ms)	
Measuring accuracy		±0.1% FS ±1 digit max. (at 23 ±5°C)			
Output mode		Input mode: Not 2-input independent measurement: HI-LO, AREA, HI-HI, LO-LO 2-input independent measurement: HI-HI, LO-LO			
Auto-zero time		0.1 to 999.9s			
Startup time		0.0 to 99.9s			
Averaging	Simple averaging/moving averaging selectable, Processing: OFF, 2, 4, 8, or 16 times				
Hold input	Minimum input signal width: 20 ms				

* An input OFF time of at least 20 ms is required.

Characteristics

Insulation resistance	100 MΩ min. (at 500 VDC) between current-carrying terminals and exposed non-current-carrying metal parts, and between non-continuous contacts
Dielectric strength	2,000 VAC, 50/60 Hz for 1 min between current-carrying metal parts and non-current-carrying metal parts 2,000 VAC, 50/60 Hz for 1 min between power supply and input circuit for all models except H7CX-□D□ (1,000 VAC for 24 VAC/12 to 24 VDC) 1,000 VAC (for H7CX-□SD□), 50/60 Hz for 1 min between control output, power supply, and input circuit (2,000 VAC for models other than H7CX-□SD□) 1,000 VAC, 50/60 Hz for 1 min between non-continuous contacts
Impulse withstand voltage	3.0 kV between power terminals (1.0 kV for models with 24 VAC/12 to 24 VDC or 12 to 24 VDC) 4.5 kV between current-carrying terminals and exposed non-current-carrying metal parts (1.5 kV for models with 24 VAC/12 to 24 VDC or 12 to 24 VDC)
Noise immunity	±1.5 kV between power terminals (±480 V for models with 12 to 24 VDC) ±600 V between input terminals Square-wave noise by noise simulator (pulse width: 100 ns/1 μs, 1-ns rise)
Static immunity	Malfunction: 8 kV Destruction: 15 kV
Vibration resistance	Destruction: 10 to 55 Hz with 0.75-mm single amplitude each in three directions for 2 h each
	Malfunction: 10 to 55 Hz with 0.35-mm single amplitude each in three directions for 10 min each
Shock resistance	Destruction: 300 m/s ² each in three directions
	Malfunction: 100 m/s ² each in three directions
Life expectancy	Mechanical: 10,000,000 operations min. Electrical: 100,000 operations min. (3 A at 250 VAC, resistive load, ambient temperature condition: 23°C)*
Weight	Approx. 130 g (Counter only)

* Refer to the Life-test Curve.

Applicable Standards

Approved safety standards	cULus (or cURus): UL508/CSA C22.2 No. 14* EN 61010-1 (IEC 61010-1): Pollution degree 2/overvoltage category II B300 PILOT DUTY 1/4 HP 120 VAC, 1/3 HP, 240 VAC, 3 A resistive load VDE0106/P100 (finger protection)	
EMC	(EMI)	EN61326
	Emission Enclosure:	EN 55011 Group 1 class A
	Emission AC mains:	EN 55011 Group 1 class A
	(EMS)	EN61326
	Immunity ESD:	EN 61000-4-2: 4 kV contact discharge; 8 kV air discharge
	Immunity RF-interference:	EN 61000-4-3: 10 V/m (Amplitude-modulated, 80 MHz to 1 GHz); 10 V/m (Pulse-modulated, 900 MHz ±5 MHz)
	Immunity Conducted Disturbance:	EN 61000-4-6: 10 V (0.15 to 80 MHz)
	Immunity Burst:	EN 61000-4-4: 2 kV power-line; 1 kV I/O signal-line
Immunity Surge:	EN 61000-4-5: 1 kV line to lines (power and output lines); 2 kV line to ground (power and output lines)	
Immunity Voltage Dip/Interruption:	EN 61000-4-11: 0.5 cycle, 100% (rated voltage)	

* The following safety standards apply to models with sockets (H7CX-A11□ or H7CX-A114□).

cUL (Listing): Applicable when an OMRON P2CF(-E) Socket is used.

cUR (Recognition): Applicable when any other socket is used.

Life-test Curve (Reference Values)

Resistive load



Inductive load



A current of 0.15 A max. can be switched at 125 VDC (cosφ=1) and current of 0.1 A max. can be switched if L/R=7 ms. In both cases, a life of 100,000 operations can be expected.

I/O Functions

Using as a Counter*1

Inputs	CP1, CP2	(1) In general (except for Dual Counter Mode) <ul style="list-style-type: none"> • Reads counting signals. • Increment, decrement, command, individual, and quadrature inputs accepted. (2) When used as a dual counter or twin counter <ul style="list-style-type: none"> • Reads CP1 count signals with CP1 input and CP2 count signals with CP2 input. • Increment signals can be input.
	Reset/reset 1	(1) In general (except for Dual Counter Mode) <ul style="list-style-type: none"> • Resets present value and outputs (OUT2 when using the batch counter)*2. • Counting cannot be performed during reset/reset 1 input. • Reset indicator is lit while reset input is ON. (2) When used as a dual counter or twin counter. <ul style="list-style-type: none"> • Resets the CP1 present value (to 0). • Counting for CP1 input cannot be performed while the reset 1 input is ON. • The reset indicator is lit while the reset 1 input is ON.
	Total reset or reset 2	The reset function depends on the selected configuration*3.
Outputs	OUT1, OUT2	Outputs signals according to the specified output mode when a set value is reached.

*1. For information on operation of I/O functions, refer to pages page 22 to page 25.

*2. In increment mode or increment/decrement mode, the present value returns to 0; in decrement mode, the present value returns to the set value with 1-stage models, and returns to set value 2 with 2-stage models.

*3. Reset operates as described in the following table. (The reset indicator will not be lit.)

Configuration	Reset operation
1-stage/2-stage preset counter	Does not operate (not used).
Total and preset counter	<ul style="list-style-type: none"> • Resets the total count value. • The total count value is held at 0 while the total reset input is ON.
Batch counter	<ul style="list-style-type: none"> • Resets the batch count value and batch output (OUT1). • The batch count value is held at 0 while the reset 2 input is ON.
Dual counter	<ul style="list-style-type: none"> • Resets the CP2 present value. • Counting for CP2 input cannot be performed while the reset 2 input is ON.
Twin counter	<ul style="list-style-type: none"> • Resets the CP2 present value.

• The following table shows the delay from when the reset signal is input until the output is turned OFF. (Reference values)

Minimum reset signal width	Output delay time
1 ms	0.8 to 1.2 ms
20 ms	15 to 25 ms

Operating Procedures (Tachometer Function)

Inputs	CP1, CP2	Reads counting signals. (The CP2 input can be used when the input mode is not 1-input mode.)
	Reset/reset 1	<ul style="list-style-type: none"> • Holds the measurement value and outputs. (The reset 2 input can be used when the input mode is 2-input independent measurement.) • Functions as a hold input. The measurement value (displayed value) and the outputs are held while the RST Key on the front panel is pressed. • The reset indicator is lit when the value is being held.
Outputs	OUT1, OUT2	Outputs signals according to the specified output mode when a set value is reached.

H7CX-A□-N

Connections

Terminal Arrangement

Confirm that the power supply meets specifications before use.

H7CX-A-N/A4-N	H7CX-AD-N/A4D-N	H7CX-AS-N/A4S-N
<p>1-stage Contact Output</p> 	<p>1-stage Contact Output</p>  <p>Terminals 1 and 6 are connected internally.</p>	<p>1-stage Transistor Output</p> 
<p>1-stage Transistor Output</p>  <p>Terminals 1 and 6 are connected internally.</p>	<p>2-stage Contact Output</p>  <p>*1: "AU□" Models</p>	<p>2-stage Transistor Output</p> 
<p>2-stage Transistor Output</p>  <p>Terminals 1 and 6 are connected internally.</p>	<p>1-stage Contact Output</p> 	<p>1-stage Transistor Output</p> 

Transistor Output

- The transistor output of the H7CX is isolated from the internal circuitry by a photocoupler, so the transistor output can be used as both NPN and PNP output.

- The diode connected to the collector of the output transistor is used to absorb inverted voltage that is generated when an inductive load is connected to the H7CX.

NPN Output



PNP Output



Block Diagram

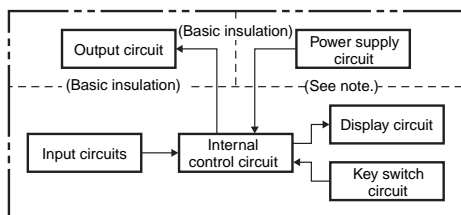

Note: All models except for H7CX-□D-N have basic insulation.

Input Circuits

CP1, CP2, Reset/Reset 1, and Total Reset/Reset 2 Input

No-voltage Inputs (NPN Inputs)



Voltage Inputs (PNP Inputs)

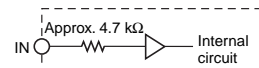

Input Connections

The inputs of the H7CX-□-N are no-voltage (short-circuit or open) inputs or voltage inputs.

No-voltage Inputs (NPN Inputs)

Open Collector



H7CX-A□	6	7	8	9	10
H7CX-A11□	3	7	5	6	4

Note: Operates with transistor ON.

Voltage Output

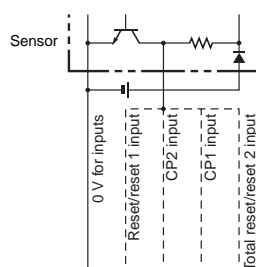

H7CX-A□	6	7	8	9	10
H7CX-A11□	3	7	5	6	4

Note: Operates with transistor ON.

Contact Input



H7CX-A□	6	7	8	9	10
H7CX-A11□	3	7	5	6	4

Note: Operates with relay ON.

DC Two-wire Sensor



H7CX-A□	6	7	8	9	10
H7CX-A11□	3	7	5	6	4

Note: Operates with transistor ON.

No-voltage Input Signal Levels

No-contact input	Short-circuit level (transistor ON)
	<ul style="list-style-type: none"> Residual voltage: 3 V max. Impedance when ON: 1 kΩ max. (The leakage current is approx. 12 mA when the impedance is 0 Ω.)
Contact input	Open level (transistor OFF)
	<ul style="list-style-type: none"> Impedance when OFF: 100 kΩ min. Use contacts which can adequately switch 5 mA at 10 V.

Note: The DC voltage must be 30 VDC max.

Applicable Two-wire Sensor
<ul style="list-style-type: none"> Leakage current: 1.5 mA max. Switching capacity: 5 mA min. Residual voltage: 3 VDC max. Operating voltage: 10 VDC

Voltage Inputs (PNP Inputs)

No-contact Input (NPN Transistor)

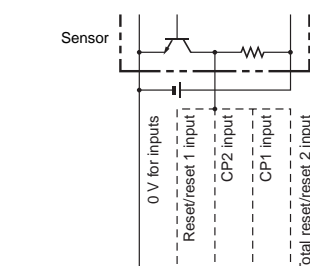

H7CX-A□	6	7	8	9	10
H7CX-A11□	3	7	5	6	4

Note: Operates with transistor OFF.

No-contact Input (PNP Transistor)

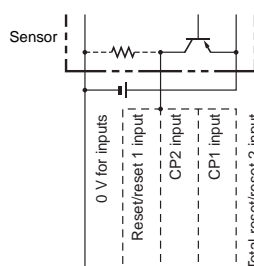

H7CX-A□	6	7	8	9	10
H7CX-A11□	3	7	5	6	4

Note: Operates with transistor ON.

Contact Input

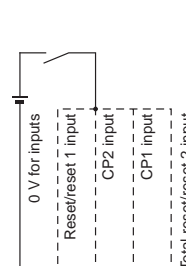

H7CX-A□	6	7	8	9	10
H7CX-A11□	3	7	5	6	4

Note: Operates with relay ON.

Voltage Input Signal Levels

High level (input ON): 4.5 to 30 VDC

Low level (input OFF): 0 to 2 VDC

Note: 1. The DC voltage must be 30 VDC max.
2. Input resistance: Approx. 4.7 kΩ

H7CX-A□-N

Nomenclature

Display Section

- 1. Key Protect Indicator** (orange)
- 2. Control Output Indicator** (orange)
OUT: (One-stage)
OUT: 1 2 (Two-stage)
- 3. Reset Indicator** (orange)
(Lit when the reset input (1) or Reset Key is ON.)
Displayed only when the configuration selection mode is not tachometer mode.
- 4. Total Count Indicator**
(Lit when the total count value is displayed.)
- 5. Batch Indicator**
(Lit when the batch count value is displayed.)
- 6. Set Value 1, 2 Stage Indicator**
- 7. Present Value (Main Display)**
(Character height: 12 mm (6-digit: 10 mm), red*)
* Characters on models with screw terminals (H7CX-A11□) can be switched between red, green, and orange.
- 8. Set value (Sub-display)**
(Character height: 6 mm, green)
- 9. Hold Display (orange)**
Displayed only when the configuration selection mode is not tachometer mode.

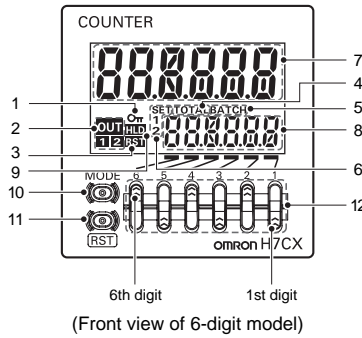
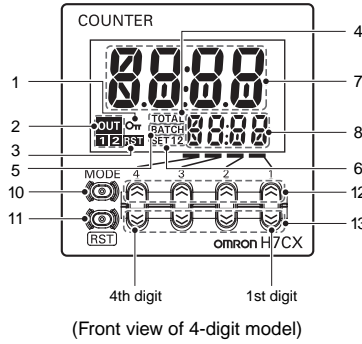

Operation Keys

- 10. Mode Key**
(Changes modes and setting items.)
- 11. Reset Key (See note.)**
- 12. Up Keys 1 to 4**
(6-digit models: 1 to 6)
- 13. Down Keys 1 to 4**

Switches

14. Key-protect Switch

(Default setting) OFF ← ON
(Disable) (Enable)



15. DIP Switch



Model with 4 Digits

Character Size for Main Display Character Size for Sub-display



Model with 6 Digits

Character Size for Main Display Character Size for Sub-display



Note: The reset functions depends on the selected configuration.

Configuration	Reset operation
1-stage/2-stage preset counter	Resets the present value and outputs.
Total and preset counter	<ul style="list-style-type: none"> Resets the present value and outputs. When the total count value is displayed, resets the present value, the total count value, and outputs.
Batch counter	<ul style="list-style-type: none"> Resets the present value and OUT2. When the batch count value is displayed, resets the present value, the batch count value, and outputs.
Dual counter	Resets the CP1 present value, CP2 present value, dual count value, and outputs.
Twin counter	Resets the CP1 present value and output 1 when the CP1 present value is displayed. Resets the CP2 present value and output 2 when the CP2 present value is displayed.
Tachometer	Holds the measurement value and outputs (hold function). (When the input mode is 2-input independent measurement, the CP1 measurement value display will hold the CP1 measurement value and output 1 and the CP2 measurement value display will hold the CP2 measurement value and output 2.)

Dimensions

(Unit: mm)

Counters

H7CX-A-N/-AS-N/-AW-N/-AWS-N/-AWD1-N/-AWSD1-N/-A4-N/-A4S-N/-A4W-N/-AU-N/-AUD1-N/-AUSD1-N
(Flush Mounting Models)



Note: M3.5 terminal screw (effective length: 6 mm)

H7CX-AD-N/-ASD-N/-AWS-D-N/-A4D-N/-A4SD-N/-A4WSD-N (Flush Mounting Models)

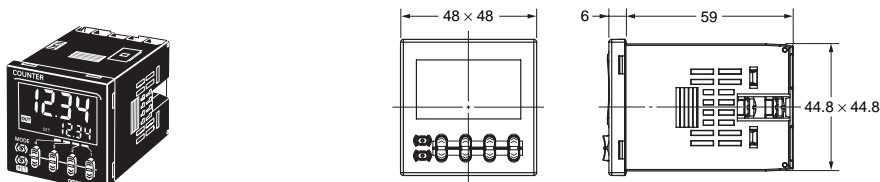

Note: M3.5 terminal screw (effective length: 6 mm)

H7CX-A11-N/-A11S-N/-A11D1-N/-A11SD1-N/-A114-N/-A114S-N/-A114D1-N (Flush Mounting/Surface Mounting Models)

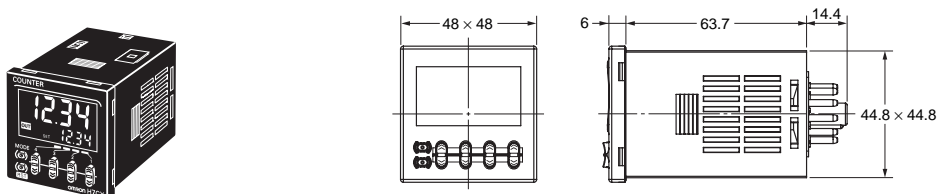

Dimensions with Flush Mounting Adapter

H7CX-A-N/-AS-N/-AW-N/-AWS-N/-AWD1-N/-AWS-D1-N/-A4-N/-A4S-N/-A4W-N (Provided with Adapter and Waterproof Packing)

Panel Cutouts
Panel cutouts are as shown below. (according to DIN43700).

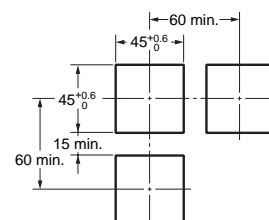
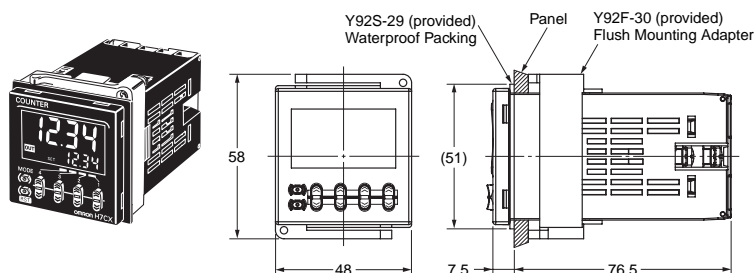

- Note:**
1. The mounting panel thickness should be 1 to 5 mm.
 2. To allow easier operation, it is recommended that Adapters be mounted so that the gap between sides with hooks is at least 15 mm (i.e., with the panel cutouts separated by at least 60 mm).
 3. It is possible to horizontally mount Timers side by side. Attach the Flush Mounting Adapters so that the surfaces without hooks are on the sides of the Timers. If they are mounted side-by-side, water-resistance will be lost.

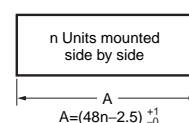

With Y92A-48F1 attached.
 $A = (48n - 2.5 + (n-1) \times 4) \pm 0.1$
With Y92A-48 attached.
 $A = (51n - 5.5) \pm 0.1$

H7CX-AD-N/-ASD-N/-AWS-D-N/-A4D-N/-A4SD-N/-A4WSD-N (Provided with Adapter and Waterproof Packing)

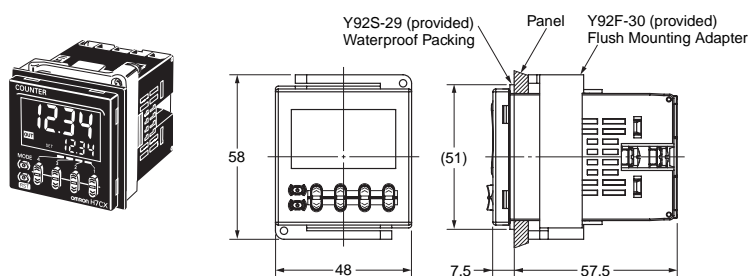

H7CX-A11-N/-A11S-N/-A11D1-N/-A11SD1-N/-A114-N/-A114S-N/-A114D1-N (Adapter and Waterproof Packing Ordered Separately)

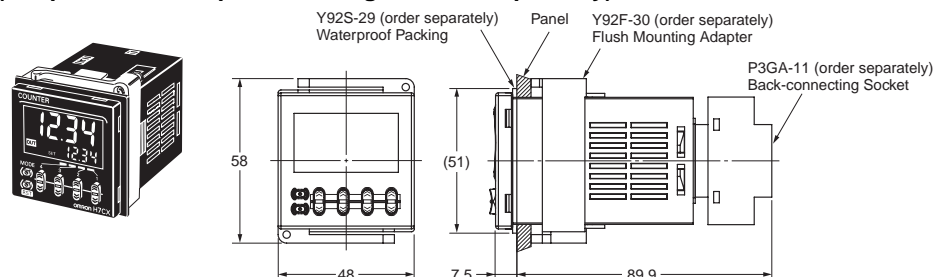

Dimensions with Front Connecting Socket

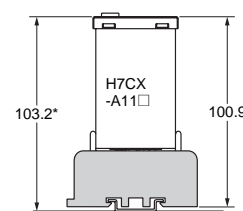

P2CF-11(-E) Front Connecting Socket (order separately)

* These dimensions depend on the kind of DIN Track. (Reference value)

Accessories (Order Separately)

Note: Depending on the operating environment, the condition of resin products may deteriorate, and may shrink or become harder. Therefore, it is recommended that resin products are replaced regularly.

Front Panel (Replacement Part)

You can change the color of the Front Panel when mounting the Counter/Tachometer. The Counter/Tachometer is shipped with a black (N1.5) Front Panel. "COUNTER" is printed on the front of Replacement Front Panels.

Y92P-CXC4G

4-digit Counter
Light gray (5Y7/1)

Y92P-CXC4S

4-digit Counter
White (5Y9.2/0.5)

Y92P-CXT4B

4-digit Counter
Black (N1.5)

Y92P-CXT6G

6-digit Counter
Light gray (5Y7/1)

Y92P-CXT6S

6-digit Counter
White (5Y9.2/0.5)

Y92P-CXT6B

6-digit Counter
Black (N1.5)



Replacement Method



The Front Panel is attached to the Counter/Tachometer with tabs in four locations. To remove the Front Panel, open the tabs and pull the Front Panel forward. To attach the Front Panel, press it onto the Counter/Tachometer so that all four tabs lodge into the grooves on the body of the Counter/Tachometer.

Soft Cover Y92A-48F1



Hard Cover Y92A-48

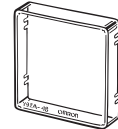

Protecting the Counter/Tachometer in Environments Subject to Oil

The H7CX's panel surface is water-resistant (conforming to IP□6, UL Type 4X) and so even if drops of water penetrate the gaps between the keys, there will be no adverse effect on internal circuits. If, however, there is a possibility of oil being present on the operator's hands, use the Soft Cover. The Soft Cover ensures protection equivalent to IP54F against oil. Do not, however, use the H7CX in locations where it would come in direct contact with oil.

Flush Mounting Adapter Y92F-30

Order the Flush Mounting Adapter with the following model number separately if it is lost or damaged.

Note: The Waterproof Packing is included with models with screw terminals.

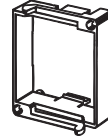

Y92F-45

Use this Adapter to install the Counter/Tachometer in a cutout previously made for a DIN 72 × 72 mm device (panel cutout: 68 × 68 mm).



Waterproof Packing Y92S-29

Note: The Waterproof Packing is included with models with screw terminals.



Order the Waterproof Packing separately if it is lost or damaged. The Waterproof Packing can be used to achieve IP66 protection.

The Waterproof Packing will deteriorate, harden, and shrink depending on the application environment. To ensure maintaining the IP□6, UL Type 4X waterproof level, periodically replace the Waterproof Packing. The periodic replacement period will depend on the application environment. You must confirm the proper replacement period. Use 1 year or less as a guideline. If the Waterproof Packing is not replaced periodically, the waterproof level will not be maintained. It is not necessary to mount the Waterproof Packing if waterproof construction is not required.

Connection Sockets Front Connecting Socket

Model	Dimensions	Terminal arrangement and internal connections	Mounting hole dimensions
P2CF-11 	 <p>Two, 4.5-dia. holes</p> <p>Eleven, M3.5 × 7.5 sems screws</p>	 <p>(Top View)</p>	 <p>Two, M4 or 4.5-dia. holes</p> <p>40±0.2</p> <p>Note: The Socket can also be mounted to DIN track.</p>
P2CF-11-E (Finger-safe Type) 	 <p>Two, 4.5-dia. holes</p> <p>Eleven, M3.5 × 7.5 set screws</p>	 <p>(Top View)</p>	<p>Two, M4 or 4.5-dia. holes</p> <p>40±0.2</p> <p>Note: The Socket can also be mounted to DIN track.</p>

Note: Round crimp terminals cannot be used on Finger-safe Sockets. Use forked crimp terminals.

Back-connecting Sockets

Model	Dimensions	Terminal arrangement and internal connections
P3GA-11 		 <p>(Bottom View)</p>

Note: A Y92A-48G Terminal Cover can be used with the Socket to create a finger-safe construction.

Terminal Covers for P3GA-11 Back-connecting Socket

Model	Dimensions
Y92A-48G 	 <p>Twelve, 6.4-dia. holes</p> <p>34</p> <p>47.7 × 47.7</p> <p>48 × 48</p> <p>16.5</p> <p>24.6</p> <p>27.6</p> <p>47.4</p>

Note: The Terminal Cover can be used with a Back-mounting Socket (P3GA-11) to create a finger-safe construction.

Optional Products for Track Mounting

Mounting Track

PFP-100N

PFP-50N



Mounting Track

PFP-100N2



End Plate

PFP-M

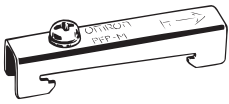

Spacer

PFP-S



Note: Order Spacers in increments of 10.

Operating Procedures

Setting Procedure Guide

Setting for Counter Operation *

Use the following settings.

Setting for Tachometer Operation *

Refer to page 27.

* At the time of delivery, the H7CX is set to the 1-stage preset counter configuration. (2-stage models are set to the 2-stage preset counter configuration.) Refer to page 35 for information on switching models.

I/O Functions for Counter Operation

Step1 Set the basic parameters.
(If the desired I/O mode is not listed below or to set all parameters using the front panel keys, perform **Step3**, below.)



Item	OFF	ON	
1	DIP switch settings	Disabled	Enabled
2	Counting speed	30 Hz	5 kHz
3	Input mode	UP	DOWN
4	Output mode	Refer to the table on the right.	
5			
6	Output time	0.5 s	0.05 s
7	Minimum reset signal	20 ms	1 ms
8	Input selection	NPN	PNP

Pin 4	Pin 5	Output mode
OFF	OFF	N
ON	OFF	F
OFF	ON	C
ON	ON	K-1

Note: All pins are factory-set to OFF.

- When setting functions using the DIP switch, be sure to set pin 1 of the DIP switch to ON.
- DIP switch settings are effective when the power is turned ON again. (Perform DIP switch settings while the power is OFF.)

Step2 The H7CX-A□-N is a Counter that contains more than one functional counter. When using the Counter in any mode other than the default mode*, use the following chart to enter Configuration Selection Mode and set the functions that are suitable to the application.

* The default mode is 1-stage preset counter configuration (2-stage preset counter configuration for 2-stage models).

Note: **Step2** can be performed first, followed by **Step1**.



Note: The configuration that can be selected depends on the model.

After making DIP switch settings for basic operations, advanced functions can be added using the operation keys. For details, refer to page 16.

Step3 Parameters that cannot be set with the DIP switch are set with the operation keys on the front panel.

Change to Function Setting Mode.



For details on operations and display in run mode, refer to page page 20. The display depends on the selected configuration.

- *1 If the mode is switched to the function setting mode during operation, operation will continue.
- *2 Changes made to settings in function setting mode are enabled for the first time when the mode is changed to run mode. Also, when settings are changed, the counter is reset (present value initialized and output turned OFF) on returning to run mode.

The characters displayed in reverse video are the default settings. When performing settings with operation keys only, set pin1 of the DIP switch to OFF (factory setting). If pin 1 of the DIP switch is set to ON, the setting items indicated by will not be displayed. For 6-digit models, only Keys are provided. Displays for 6-digit models are given in parentheses.



• Set the input mode using the Keys.



Note: Displayed only when Twin Counter Mode is not selected.
*5 Displayed for output modes other than K-2, D, L, and H only.

• Set the output mode using the Keys.



*6 Displayed only when the input mode is Ud-R, Ud-b, or Ud-Ē. (Not displayed when the function is set to tñ.)

• Set each digit using the individual Keys.



Note: Displayed only when the output mode is C, R, K-1, P, Q, A, or K-2.

• Set the counting speed using the Keys.



• Set the Reset input signal width using the Keys.

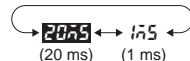

• Set the decimal point position using the Keys.



• Set each digit using the individual Keys.



• Set the NPN/PNP input mode using the Keys.



• Set the display color using the Keys.

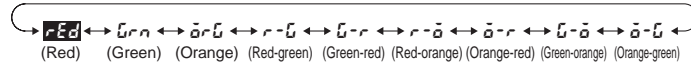

Note: Displayed for terminal-block models (except H7CX-A11□) only.

*3 When Using Dual Counter Operation

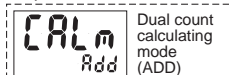

• Set the dual count calculating mode using the Keys.



*4 Displayed only when the output mode is K-2, D, L, or H.

Usage as a Decrementing Counter (Sub)

The Subb parameter is normally not displayed. You must set the dññ parameter shown below in advance to *6 (μ-2, d, L, or H) to display it.

*7 Set each digit using the individual Keys.

When using as a 2-stage preset counter

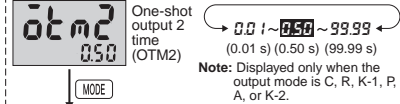

Note: Displayed only when the output mode is C, R, K-1, P, Q, A, or K-2.



Note: Displayed for output modes other than D, L, and H. HOLD cannot be set when the output mode is K-2.

When using as a batch counter



Note: Displayed only when the output mode is C, R, K-1, P, Q, A, or K-2.

*7 Set each digit using the individual Keys.

Twin Counter

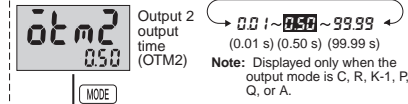

Note: Displayed only when the output mode is C, R, K-1, P, Q, or A.

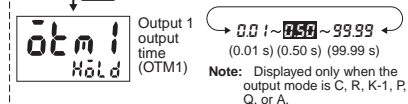

Note: Displayed only when the output mode is C, R, K-1, P, Q, or A.

From next page To next page

Function Setting Mode



• Make the absolute value setting and forecast setting using the () Keys.



Note: Displayed only when the configuration selection mode is set to the 2-stage function $2\bar{C}n\bar{E}$.

• Set each digit using the individual () Keys.



Note: 1 to 999999 for 6-digit models

• Set each digit using the individual () Keys.



Note: 1 to 999999 for 6-digit models.

Note: Displayed only when the configuration selection mode is set to the 2-stage function $2\bar{C}n\bar{E}$ and a forecast value is set.

• Set each digit using the individual () Keys.



Note: 1 to 999999 for 6-digit models.

Note: Displayed only when the output mode is set to $b\bar{C}n\bar{E}$.



Note: Displayed only for "-AU□" models.

ōFF: Output 1 = 12, 13, Output 2 = 3, 4, 5 ōn: Output 1 = 3, 4, 5, Output 2 = 12, 13
The numbers are the terminals numbers.

• Set the key protect level using the () Keys.



*8 Set each digit using the individual () Keys.

Procedure for Models Other than "-□W□" Models

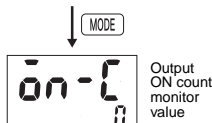

Note: The monitor value is only displayed. It cannot be set.

Procedure for "-□W□" Models

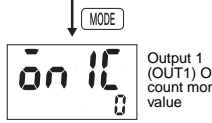
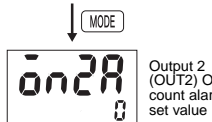

Note: The monitor value is only displayed. It cannot be set.

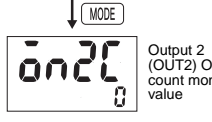

Note: The monitor value is only displayed. It cannot be set.

H7CX-A□-N Counter

Explanation of Functions

Items marked with stars ★ can be set using the DIP switch.

Input Mode (┌┐┌┐)★

Set increment mode (UP), decrement mode (DOWN), or one of the increment/decrement modes (UP/DOWN A, UP/DOWN B, or UP/DOWN C) as the input mode.

Input modes other than UP or DOWN modes cannot be set using the DIP switch and so use the operation keys if other modes are required. (For details on the operation of the input modes, refer to *Input Modes and Present Value* on page page 21.)

Dual Count Calculating Mode (┌┐┌┐)★

When using as a dual counter, select either ADD (addition) or SUB (subtraction) as the calculation method for the dual count value.

ADD: Dual count value = CP1 PV + CP2 PV

SUB: Dual count value = CP1 PV – CP2 PV

Output Mode (┌┐┌┐)★

Set the way that control output for the present value is output. The possible settings are N, F, C, R, K-1, P, Q, A, K-2, D, L, and H.

Output modes other than N, F, C, or K-1 cannot be set using the DIP switch and so use the operation keys if other modes are required. The output modes that can be set vary with the model.

(For details on the operation of the output modes, refer to *Input/Output Mode Settings* on page page 22.)

One-shot Output Time (┌┐┌┐)★

Set the one-shot output time (0.01 to 99.99 s) for control output.

One-shot output can be used only when C, R, K-1, P, Q, A, or K-2 is selected as the output mode. Output times other than 0.5 s or 0.05 s cannot be set with the DIP switch and so use the operation keys if other settings are required.

One-shot Output 2 Time (┌┐┌┐)★

Set the one-shot output time (0.01 to 99.99 s) for control output (OUT2).

One-shot output can be used only when C, R, K-1, P, Q, A, or K-2 is selected as the output mode. Output times other than 0.5 s or 0.05 s cannot be set with the DIP switch and so use the operation keys if other settings are required.

One-shot Output 1 Time (┌┐┌┐)★

Set the one-shot output time (0.01 to 99.99 s) for control output (OUT1).

One-shot output can be used only when D, L, or H is selected as the output mode.

If the output time is set to 0.00, $\overline{H\overline{d}L\overline{d}}$ is displayed, and outputs are held.

Counting Speed (┌┐┌┐)★

Set the maximum counting speed (30 Hz/5 kHz) for CP1 and CP2 inputs together.

If contacts are used for input signals, set the counting speed to 30 Hz. Processing to eliminate chattering is performed for this setting.

Reset Input Signal Width (┌┐┌┐)★

Set the reset input signal width (20 ms/1 ms) for reset/reset 1 and total reset/reset 2 inputs together.

If contacts are used for the input signal, set the input signal width to 20 ms. Processing to eliminate chattering is performed for this setting.

Decimal Point Position (┌┐)★

Decide the decimal point position for the present value, CP1/CP2 present values, set value (SV1, SV2), total count value, and dual count set value.

Prescale Value (┌┐┌┐)

Pulses input to the counter are converted according to the specified prescale value.

(Setting range: 0.001 to 99.999 for 6-digit models and 0.001 to 9.999 for 4-digit models.)

Example: To display the feed distance for systems that output 25 pulses for a feed length of 0.5 m in the form □□.□□ m:

1. Set the decimal point position to 2 decimal places.
2. Set the prescale value to 0.02 (0.5 ÷ 25).



- Observe the following points when setting a prescale value. Set the set value to a value less than {Maximum countable value – Prescale value}. Example: If the prescale value is 1.25 and the counting range is 0.000 to 999.999, set the set value to a value less than 998.749 (= 999.999 – 1.25). If the set value is set to a value greater than this, output will not turn ON.
- Output will turn ON, however, if a present value overflow occurs (FFFFFF or FFFF).

Note: If the prescale value setting is incorrect, a counting error will occur. Check that the settings are correct before using this function.

NPN/PNP Input Mode (┌┐┌┐)

Select either NPN input (no-voltage input) or PNP input (voltage input) as the input format. When using a two-wire sensor, select NPN input.

The same setting is used for all external inputs.

For details on input connections, refer to *Input Connections* on page page 9.

Display Color (┌┐┌┐) (Displayed for terminal block models (except H7CX-A11□) only.)

Set the color used for the present value.

	Output OFF*	Output ON*
$\overline{r}E\overline{d}$	Red (fixed)	
$\overline{G}r\overline{n}$	Green (fixed)	
$\overline{o}r\overline{G}$	Orange (fixed)	
$r-\overline{G}$	Red	Green
$\overline{G}-r$	Green	Red
$r-\overline{o}$	Red	Orange
$\overline{o}-r$	Orange	Red
$\overline{G}-\overline{o}$	Green	Orange
$\overline{o}-\overline{G}$	Orange	Green

* Output 2 for 2-stage models.

With the twin counter, output 1 and output 2 will both turn OFF when the output status is OFF. Either output 1 or output 2 will turn ON when the output status is ON.

Absolute Value Setting/Forecast Value Setting (5E5)

For the 2 count output mode, an absolute value setting (Rb5) or forecast value setting (aF5E) can be set for set value 1.

When a forecast value is set, specify the forecast value set value (i.e., the deviation for the set value).

The forecast output (output 1) turns ON when the present value reaches the forecast value.

If the forecast set value is greater than or equal to the set value, the forecast output (output 1) will turn ON as soon as counting starts.



If the forecast value setting is used, specify the set value 2 minus the forecast value setting for set value 1.



Set Value Upper Limit (5L -H)

Set the upper limit for the set value when it is set in run mode.

The setting can be made from 1 to 9999 for 4-digit models and from 1 to 999999 for 6-digit models.

Forecast Set Upper Limit (PL -H)

Set the upper limit for the forecast set value.

The setting can be made from 1 to 9999 for 4-digit models and from 1 to 999999 for 6-digit models.

Batch Count Upper Limit (bL -H)

Set the upper limit for the batch count value. The setting can be made from 1 to 9999 for 4-digit models and from 1 to 999999 for 6-digit models.

Output Allocation (aE5E)

When using an H7CX-AU□-N model as a 2-stage counter, the output can be flexibly allocated to either stage 1 or 2.

The transistor output can be allocated to SV1 and the contact output to SV2 or vice versa, as in the following tables.

H7CX-AU-N/AUD1-N

	Output 1	Output 2
aFF	Transistor (12-13)	Contact (3, 4, 5)
aE	Contact (3, 4, 5)	Transistor (12-13)

H7CX-AUSD1-N

	Output 1	Output 2
aFF	Transistor (12-13)	Transistor with diode (3, 4, 5)
aE	Transistor with diode (3, 4, 5)	Transistor (12-13)

Key Protect Level (K YPE)

Set the key protect level.

Refer to *Key Protect Level* on page page 36.

Output ON Count Alarm Set Value (aE -R)

Set the alarm value for the output ON count.

The limit can be set to between 0×1000 (0 times) and 9999×1000 (9,999,000 times). Only the underlined values are set. The alarm will be disabled if 0 is set.

If the total ON count of the output exceeds the alarm set value, E3 will be displayed on the Timer to indicate that the output ON count alarm value was exceeded. Refer to *Self-diagnostic Function* on page page 36 for information on the E3 display.

ON Count Alarm Set Values for Outputs 1 and 2 (OUT1 and OUT2) (aE 1R and aE 2R)

Set the ON count alarm values for the outputs 1 and 2.

The limit can be set to between 0×1000 (0 times) and 9999×1000 (9,999,000 times). Only the underlined values are set. The alarm will be disabled if 0 is set.

If the total ON count of instantaneous output 1 or 2 exceeds the alarm set value, E3 will be displayed on the Timer to indicate that the output ON count alarm value was exceeded. Refer to *Self-diagnostic Function* on page page 36 for information on the E3 display.

Output ON Count Monitor Value (aE -L)

The monitor value is only displayed. It cannot be set.

The output ON count will be 1,000 times the displayed value.

ON Count Monitor Values for Outputs 1 and 2 (OUT1 and OUT2) (aE 1L and aE 2L)

The monitor value for output 1 or 2 is only displayed. It cannot be set.

The output ON count will be 1,000 times the displayed value.

Operation in Run Mode

I/O Functions for Counter Operation

- Set values for each digit as required using the \curvearrowright (\curvearrowleft) Keys. (\curvearrowright Key only for 6-digit models.)



1-stage Preset Counter



2-stage Preset Counter with Absolute Value Setting



- Present Value**
Shows the present count value.
- Set Values (Set Value 1 and Set Value 2)**
Set the set values.
When the present value reaches the set value (set value 1 or set value 2), a signal is output according to the specified output mode.

2-stage Preset Counter with Forecast Value Setting



- Present Value**
Shows the present count value.
- Set Values**
Set the set values.
- Forecast Set Value**
Set the deviation for the set value.

Total and Preset Counter



- Present Value/Set Value**
Same as 1-stage preset counter.
- Total Count Value**
Shows the present total count value.

Batch Counter

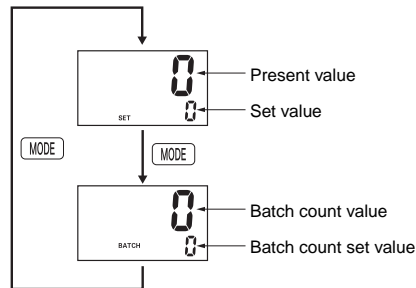

- Present Value/Set Value**
Same as 1-stage preset counter.
- Batch Count Value**
Shows the number of times the count has been completed for the present value.
- Batch Count Set Value**
Set the batch count set value.
When the batch count value reaches the batch count set value, batch output (OUT1) turns ON.

Dual Counter



- Dual Count Value**
Shows the sum of the CP1 present value and CP2 present value when the dual count calculating mode is ADD and shows the value obtained by subtracting the CP2 present value from the CP1 present value when the dual count calculating mode is SUB.
- Dual Count Set Value**
Set the dual count set value.
When the dual count value reaches the dual count set value, signals are output according to the specified output mode.
- CP1/CP2 Present Value**
Show the present count values for CP1 and CP2 present values respectively.

Twin Counter



- Present Values 1 and 2**
Shows the present count value 1 or 2.
- Set Values 1 and 2**
Setting for present value 1 or 2.

Input Modes and Present Value (See note 1.) I/O Functions for Counter Operation



* Counting starts when the CP1 is turned ON after turning ON the power.



Input/Output Mode Settings

I/O Functions for Counter Operation

If a 1-stage model or 2-stage model is incorrectly used as twin counter, the operation for output 2 will be performed. When using a 2-stage model as a 1-stage preset counter, total and preset counter, or dual counter, OUT1 and OUT2 turn ON and OFF simultaneously.

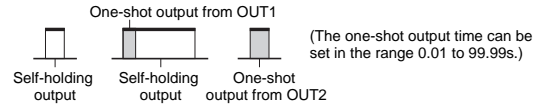

		Input mode			Operation after count completion
		UP	DOWN	UP/DOWN A, B, C	
Output mode setting	N				The outputs and present value display are held until reset/reset 1 is input.
	F				The present value display continues to increase/decrease. The outputs are held until reset/reset 1 is input.
	C				As soon as the count reaches SV, the present value display returns to the reset start status. The present value display does not show the present value upon count-up. The outputs repeat one-shot operation. OUT1 self-holding output turns OFF after the OUT2 one-shot output time. The OUT1 one-shot output time is independent of OUT2.
	R				The present value display returns to the reset start status after the one-shot output time. The outputs repeat one-shot operation. OUT1 self-holding output turns OFF after the OUT2 one-shot output time. The OUT1 one-shot output time is independent of OUT2.
	K-1				The present value display continues to increase/decrease. OUT1 self-holding output turns OFF after the OUT2 one-shot output time. The OUT1 one-shot output time is independent of OUT2.



		Input mode			Operation after count completion
		UP	DOWN	UP/DOWN A, B, C	
Output mode setting	P				The present value display does not change during the one-shot output time period, but the actual count returns to the reset start status. The output will return to one-shot mode. The outputs repeat one-shot operation. OUT1 self-holding output turns OFF after the OUT2 one-shot output time. The OUT1 one-shot output time is independent of OUT2.
	Q				The present value continues to increase/decrease for the one-shot output time, but returns to the reset start status after the one-shot output time has elapsed. The outputs repeat one-shot operation. OUT1 self-holding output turns OFF after the OUT2 one-shot output time. The OUT1 one-shot output time is independent of OUT2.
	A				The present value display and OUT1 self-holding output is held until reset/reset 1 is input. OUT1 and OUT2 are independent.

- Note:**
1. The full scale (FS) for H7CX 4-digit models is 9999.
 2. When the present value reaches 999999, it returns to 0.
 3. Counting cannot be performed during reset/reset 1 input.
 4. If reset/reset 1 is input while one-shot output is ON, one-shot output turns OFF.
 5. If there is power failure while output is ON, output will turn ON again when the power supply has recovered.
For one-shot output, output will turn ON again for the duration of the output time setting once the power supply has recovered.
 6. Do not use the counter function in applications where the count may be completed (again) while one-shot output is ON.
 7. The setting range is 0 to 999999 (0 to 9999 for 4-digit models).

H7CX-A□-N Counter



		Input mode	Operation after count completion
		UP/DOWN A, B, C	
Output mode setting	K-2		The display continues to increase/decrease until the overflow or underflow value is reached. One-shot output only.
	D		The display continues to increase/decrease until the overflow or underflow value is reached. The outputs are ON while the count is equal.
	L		The display continues to increase/decrease until the overflow or underflow value is reached. OUT1 is held while the present value is less than or equal to set value 1. OUT2 is held while the present value is greater than or equal to set value 2.
	H		The display continues to increase/decrease until the overflow or underflow value is reached. OUT1 is held while the present value is greater than or equal to set value 1. OUT2 is held while the present value is greater than or equal to set value 2. * H mode is available only when using a model as a 2-stage counter.

- Note:**
- Counting cannot be performed during reset/reset 1 input.
 - If reset/reset 1 is input while one-shot output is ON, one-shot output turns OFF.
 - If there is power failure while output is ON, output will turn ON again when the power supply has recovered. For one-shot output, output will turn ON again for the duration of the output time setting once the power supply has recovered.
 - Do not use the counter function in applications where the count may be completed (again) while one-shot output is ON.
 - The set value is from -99999 to 999999 (-999 to 9999 for 4-digit models).

Total and Preset Counter Operation

The H7CX has a total counter, separate from the 1-stage preset counter, for counting the total accumulated value.



- The total counter continues to count the total accumulated value when the present value is reset using reset/reset 1 input (Reset Key).
- The total count value is reset when the total reset/reset 2 input is turned ON. If the Reset Key is pressed while the total count value is displayed, the total count value is reset. The present value is also reset at this time.
- The counting range of the total counter is -99,999 to 999,999 (-999 to 9,999). The total count value returns to 0 when it reaches the full scale limit.

Batch Counter Operation

The H7CX has a batch counter, separate from the 1-stage preset counter, for counting the number of times the count has been completed.



- The batch counter continues after count completion.
- Batch output is held until batch counter reset is input.
- When the batch counter reset input is turned ON, the batch count value is reset, and batch output turns OFF.
- If the Reset Key is pressed while the batch count value is displayed, the batch count value is reset and batch output turns OFF. The present value is also reset at this time.
- The count value can be incremented and decremented. The batch count is only incremented.
- The maximum counting speed for batch counter operation is 5 kHz. The batch counter counts the number of times the count reaches the set value.

- Note:**
1. The batch count value is held at 0 during batch counter reset input.
 2. If the batch count set value is 0, batch count will be performed but there will be no batch output.
 3. The batch count value returns to 0 when it reaches 999,999 (9,999 for 4-digit models).
 4. Once batch input has been turned ON, it will return to the ON state after power interruptions.
 5. If the batch count set value is changed from a value that is greater than the batch count value to one that is less, batch output will turn ON.
 6. After batch output turns ON, the ON state will be held even if the batch count set value is changed to a value greater than the batch count value.

Dual Counter Operation

Using the dual counter allows the count from 2 inputs to be added or subtracted and the result displayed. It is possible to specify a set value for which output turns ON when the set value matches the added or subtracted result.

(1) Dual Count Calculating Mode = ADD Dual count value = CP1 PV + CP2 PV



(2) Dual Count Calculating Mode = SUB Dual count value = CP1 PV - CP2 PV

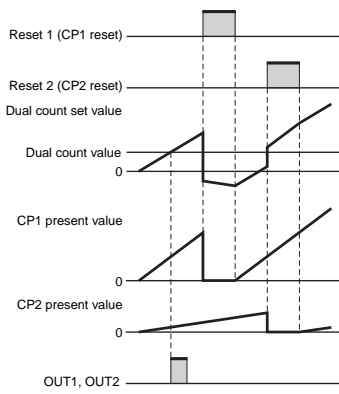

- The operation after count completion for the dual counter value is determined by the output mode.
- The CP1 present value is reset when reset 1 input is turned ON. The CP2 present value is reset when reset 2 input is turned ON.
- If the Reset Key is pressed while the dual count value, CP1 present value, or CP2 present value is displayed, all of the present values are reset and outputs turn OFF. At this time, counting is not possible for CP1 or CP2 inputs.

- Note:**
1. Counting is not possible for CP1 during reset 1 input. CP2 will not be affected. The dual count value will be calculated based on a CP1 present value of 0.
 2. Counting is not possible for CP2 during reset 2 input. CP1 will not be affected. The dual count value will be calculated based on a CP2 present value of 0.
 3. The counting range for the dual count value is -99,999 to 999,999 (0 to 9,999 for 4-digit models). The counting ranges for the CP1 present value and CP2 present value are 0 to 999,999 (0 to 9,999 for 4-digit models). If a present value exceeds 999,999 (9,999 for 4-digit models), FFFFFFFF (FFFFF for 4-digit models) will be displayed to indicate an overflow, and all counting will stop.

H7CX-A□-N Counter

Twin Counter Operation

Two independent counters are built in.

	Counter 1	Counter 2
Counter input	CP1	CP2
Reset input	Reset 1	Reset 2
Present value display and setting	<p>Counter 1 display Counter 2 display</p> <p>Counter 1 present value Counter 2 present value</p> <p>Counter 1 set value Counter 2 set value</p> <p>Switched with the [MODE] Key.</p>	
Reset Key	Only counters appearing on the display will be reset.	

- Note:**
1. Only 2-stage models
 2. Increment mode only for counters 1 and 2.
 3. The settings for prescaling and the decimal point are used by both counter 1 and 2.

Reset Function List

I/O Functions for Counter Operation

Function	1-stage/2-stage preset counter	Total and preset counter		Batch counter		Dual counter		Twin counter	
		Present value/set value	Total count value	Present value/set value	Batch count value/batch count set value	Dual count value/dual count set value	CP1 present value/CP2 present value	Present value 1/Set value 1	Present value 2/Set value 2
Reset/reset 1	Present value and output reset.	Present value and output reset.		Present value and output reset.		Only the CP1 present value is reset.		Only the CP1 present value is reset.	
Total reset or reset 2	No effect	Only the total count value is reset.		Batch count value and batch output reset.		Only the CP2 present value is reset.		Only the CP2 present value is reset.	
Reset Key	Present value and output reset.	Present value and output reset.	Present value, total count value, and output reset.	Present value and output reset.	Present value, batch count value, output and batch output reset.	CP1 present value, CP2 present value, dual count value, and output reset.		CP1 present value reset	CP2 present value reset

- The following table shows the delay from when the present value passes the set value until the output is produced.

Actual measurements in N and K-2 modes (Reference values)

Control output type	Max. counting speed	Output delay time
Contact output	30 Hz	16.5 to 24.0 ms
	5 kHz	3.7 to 5.6 ms
Transistor output	30 Hz	12.0 to 20.0 ms
	5 kHz	0.2 to 0.55 ms

Note: The above times may vary slightly depending on the mode or operating conditions.

Setting Procedure Guide

Tachometer Operation

Step1 The H7CX is factory-set to the 2-stage counter configuration (1-stage counter configuration for H7CX-AU□-N models).
Enter configuration selection mode using the following chart and set the tachometer mode.

Note: **Step2** can be performed first, followed by **Step1**.

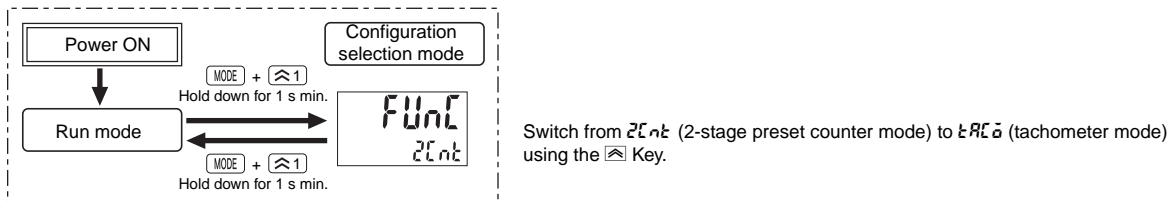

Step2 Set the basic parameters.
(If the desired I/O mode is not listed below or to set all parameters using the front panel keys, perform **Step3**, below.)

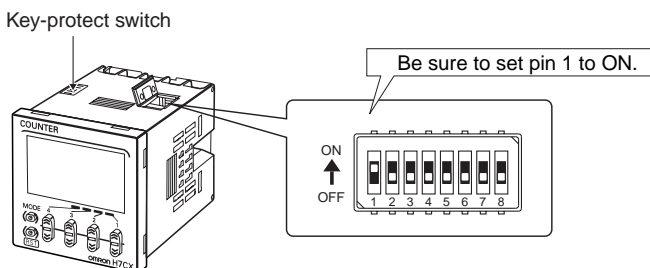

	Item	OFF	ON
1	DIP switch settings	Disabled	Enabled
2	Counting speed	30 Hz	10 kHz
3	Tachometer output mode	Refer to the table on the right.	
4			
5	Average processing	Refer to the table on the right.	
6			
7	---	---	---
8	Input selection	NPN	PNP

Pin 3	Pin 4	Tachometer output mode
OFF	OFF	Upper/lower limit output
ON	OFF	Range output
OFF	ON	Upper limit output
ON	ON	Lower limit output

Pin 5	Pin 6	Average processing
OFF	OFF	OFF
ON	OFF	2 times
OFF	ON	4 times
ON	ON	8 times

Note: All pins are factory-set to OFF.

- When setting functions using the DIP switch, be sure to set pin 1 of the DIP switch to ON.
- DIP switch settings are effective when the power is turned ON again. (Perform DIP switch settings while the power is OFF.)

After making DIP switch settings for basic operations, advanced functions can be added using the operation keys.
For details, refer to page page 28.

Step3 Parameters that cannot be set with the DIP switch are set with the operation keys on the front panel.

Change to Function Setting Mode.

For details on operations and display in run mode, refer to page page 33.



*1 If the mode is switched to the function setting mode during operation, operation will continue.

*2 Changes made to settings in function setting mode are enabled for the first time when the mode is changed to run mode.

Also, when settings are changed, the counter is reset (measured value initialized and outputs turned OFF) on returning to run mode.

The characters displayed in reverse video are the default settings. When performing settings with operation keys only, set pin1 of the DIP switch to OFF (factory setting). If pin 1 of the DIP switch is set to ON, the setting items indicated by will not be displayed.



• Set the tachometer input mode using the Key.



*1 Set tachometer output modes 1 and 2 using the Key.

* Displayed only when the tachometer input mode is F2 (2 inputs).

• Set the tachometer output mode using the Key.

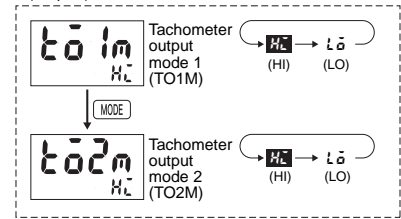

• Set the counting speed using the Key.

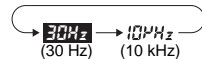

Note: Even if 10 kHz is selected when the tachometer input mode is F2 to F5, the counting speed will be 5 kHz.

• Set the decimal point position using the Key.



Note: "-.-.-.-" will be displayed when pulse width measurement is set or when the display unit is set to seconds.

• Set each digit using the individual Key.



• Set the averaging method using the Key.



• Set the number of averaging times using the Key.



• Set each digit using the individual Key.



• Set each digit using the individual Key.



From next page To next page

To previous page

From previous page

Function Setting Mode

MODE
Lmod
nPN

NPN/PNP input mode (IMOD)

• Set the NPN/PNP input mode using the Key.

nPN PnP
(NPN input) (PNP input)

MODE
COLr
rEd

Display color (COLR)

• Set the display color using the Key.

rEd Grn Orng RGrn GRed ROrng ORng GOrng ORGrn
(Red) (Green) (Orange) (Red-green) (Green-red) (Red-orange) (Orange-red) (Green-orange) (Orange-green)

MODE
dHLD
off

Peak/bottom hold enabled (DHLD)

• Enable or disable the peak/bottom hold using the Key.

off on
(Disabled) (Enabled)

MODE
HYS
0

Output hysteresis (HYS)

• Set the output hysteresis using the Key.

0 99999
(0) (99999)

Note: The measurement value after prescaling is set.

MODE
OFFd
0.00

Output OFF delay (OFFD)

• Set each digit using the individual Key.

0.00 19.99
(0.00 s) (19.99 s)

MODE
SL-H
999999

Set value upper limit (SL-H)

• Set each digit using the individual Key.

1 999999
(1) (999999)

MODE
aLSt
OFF

Output allocation change

OFF on
(OFF) (ON)

Note: Displayed only for "-AU□" models.
aLF: Output 1 = 12, 13, Output 2 = 3, 4, 5
aLr: Output 1 = 3, 4, 5, Output 2 = 12, 13
The numbers are the terminals numbers.

MODE
KYPT
KP-1

Key protect level (KYPT)

• Set the key protect level using the Key.

KP-1 KP-2 KP-3 KP-4 KP-5 KP-6 KP-7
(KP-1) (KP-2) (KP-3) (KP-4) (KP-5) (KP-6) (KP-7)

MODE
CALM
PHRS

Pulse cycle measurement/pulse width measurement (CALM)

• Set pulse cycle measurement or pulse width measurement using the Key.

PHRS PdE
(Pulse cycle measurement) (Pulse width measurement)

MODE
Unit
Hz

Display unit (UNIT)

• Set the display unit using the Key.

Hz s
(Hz) (s)

Note: Displayed only when pulse cycle measurement is used.

MODE
INTV
200ms

Measurement interval (INTV)

• Set each digit using the individual Key.

200ms Cont
(200 ms) (Cont (10 ms min.))

Note: Displayed only if the measurement speed is 10 kHz when pulse cycle measurement is used.

MODE
ONALM

Output ON count alarm set value/monitor value

*2 Set each digit using the individual Keys.

MODE
ON1A
0

Output 1 (OUT1) ON count alarm set value

0 9999
(0 x 1000 times) (9999 x 1000 times)

MODE
ON2A
0

Output 2 (OUT2) ON count alarm set value

0 9999
(0 x 1000 times) (9999 x 1000 times)

MODE
ON1M
0

Output 1 (OUT1) ON count monitor value

Note: The monitor value is only displayed. It cannot be set.

MODE
ON2M
0

Output 2 (OUT2) ON count monitor value

Note: The monitor value is only displayed. It cannot be set.

H7CX-A□-N Tachometer

Explanation of Functions

Tachometer Operation

Items marked with stars ★ can be set using the DIP switch.

Tachometer Input Mode (㉔㉒㉑)

Set the count input mode to one of the following: 1 input (㉔㉒), 2 inputs (㉔㉓), error (㉔㉔), absolute ratio (㉔㉕), or error ratio (㉔㉖).

Input mode	Input	Internal processing	Application
1 input	Count 1	None	Operation with only one input.
2 inputs	Counts 1 and 2	None	Operation with two independent inputs.
Error	Counts 1 and 2	Count 1 input – Count 2 input	Measuring the difference between two inputs (error in number of revolutions).
Absolute ratio	Counts 1 and 2	Count 1 input ÷ Count 2 input	Measuring the ratio of two inputs (ratio of number of revolutions).
Error ratio	Counts 1 and 2	(Count 1 input – Count 2 input) ÷ Count 2 input	Measuring the ratio of error for two inputs (measuring the error ratio of number of revolutions).

Tachometer Output Mode (㉔㉗㉘)★

Set the output method for control output based on the comparison value. Upper and lower limit (HI-LO), area (AREA), upper limit (HI-HI), and lower limit (LO-LO) can be set.

(For details on the output modes, refer to *Output Mode Settings and Operation* on page 34.)

Counting Speed (㉔㉙㉚)★

Set the maximum counting speed (30 Hz/10 kHz) for CP1 input. If contacts are used for input signals, set the counting speed to 30 Hz. Processing to eliminate chattering is performed for this setting.

Decimal Point Position (㉔㉛)★

Decide the decimal point position for the measurement value, OUT1 set value, and OUT2 set value.

Prescale Value (㉔㉜㉝)★

It is possible to display the rate of rotation or the speed of a device or machine to which the H7CX is mounted by converting input pulses to a desired unit.

If this prescaling function is not used, the input frequency (Hz) will be displayed.

It is also possible to specify time (seconds) as the display value. Refer to *Display Unit* on page 31 for details.

The relationship between display and input is determined by the following equation. Set the prescale value according to the unit to be displayed.

$$\text{Displayed value} = f \times \alpha$$

f: Input pulse frequency (number of pulses in 1 second)

α: Prescale value

(1) Displaying Rotation Rate

Display unit	Prescale value (α)
rpm	$1/N \times 60$
rps	$1/N$

N: Number of pulses per revolution

Example: To display the rate of rotation for a machine that outputs 5 pulses per revolution in the form □□.□ rpm:

- Set the decimal point position to 1 decimal places.
- Using the formula, set the prescale value (α) to $1/N \times 60 = 60/5 = 12$.

(2) Displaying Speed

Display unit	Prescale value (α)
m/min	$\pi d \times 1/N \times 60$
m/s	$\pi d \times 1/N$

N: Number of pulses per revolution

d: Diameter of rotating body (m)

πd: Circumference (m)



- Observe the following points when setting a prescale value. Set the set value to a value less than {Maximum countable value – Prescale value}. Example: If the prescale value is 1.25 and the counting range is 0.000 to 999.999, set the set value to a value less than 998.749 (= 999.999 – 1.25). If the set value is set to a value greater than this, output will not turn ON.

* Output will turn ON, however, if a present value overflow occurs (FFFFF or FFFF).

Note: If the prescale value setting is incorrect, a counting error will occur. Check that the settings are correct before using this function.

Averaging Method (㉔㉞㉟) (Only for Tachometer Operation)

A simple average or moving average can be selected for the averaging. With the moving average method, the average of the measurement values is displayed each sampling cycle, in contrast to a simple average, with which the the average of the set number of samples is displayed.

Number of Averaging Times (㉔㉟㊱)★

Flickering display and output chattering can be prevented using average processing. Average processing can be set to one of four levels: no average processing, 2 times (i.e., the average of 2 measurement values), 4 times, 8 times, or 16 times. The measurement cycle will be equal to the sampling cycle multiplied by the average processing setting (i.e., the number of times). Average processing enables stable displays even for fluctuating input signals. Set the optimum number of times for the application.

Auto-zero Time (㉔㊲㊳)★

The display can be force-set to 0 if there is no pulse for a certain period of time. This time is called the auto-zero time. Set the auto-zero time to a time slightly longer than the estimated interval between input pulses. Accurate measurement is not possible if the auto-zero time is set to a time shorter than the input pulse cycle. Setting a time that is too long may also result in problems, such as a time-lag between rotation stopping and the alarm turning ON. The auto-zero time is not applied to pulse width measurements.

Startup Time (㉔㊴㊵)★

To prevent undesired outputs resulting from unstable inputs immediately after the power supply is turned ON, it is possible to prohibit measurement for a set period of time, the startup time. It can also be used to stop measurements and disable outputs until the rotating body reaches the normal rate of rotation, after the power supply to the H7CX and rotating body are turned ON at the same time.

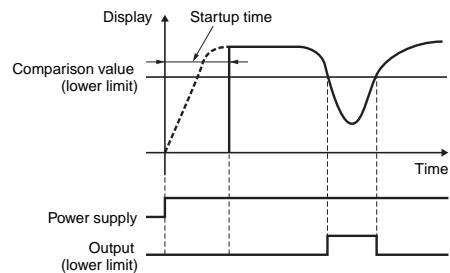

NPN/PNP Input Mode (ꠇꠇꠇꠇ)★

Select either NPN input (no-voltage input) or PNP input (voltage input) as the input format.

When using a two-wire sensor, select NPN input. The same setting is used for all external inputs.

For details on input connections, refer to *Input Connections* on page page 9.

Display Color (ꠇꠇꠇꠇ)

Set the color used for the measurement value.

	Control output OFF	Control output ON
ꠇꠇꠇꠇ	Red (fixed)	
ꠇꠇꠇꠇ	Green (fixed)	
ꠇꠇꠇꠇ	Orange (fixed)	
ꠇꠇꠇꠇ *1	Measured value is displayed in red when both control outputs 1 and 2 are OFF.	Measured value is displayed in green when either control output 1 or control output 2 is ON.
ꠇꠇꠇꠇ *2	Measured value is displayed in green when both control outputs 1 and 2 are OFF.	Measured value is displayed in red when either control output 1 or control output 2 is ON.
ꠇꠇꠇꠇ *3	Measured value is displayed in red when both control outputs 1 and 2 are OFF.	Measured value is displayed in orange when both control outputs 1 and 2 are OFF.
ꠇꠇꠇꠇ *4	Measured value is displayed in orange when both control outputs 1 and 2 are OFF.	Measured value is displayed in red when both control outputs 1 and 2 are OFF.
ꠇꠇꠇꠇ *5	Measured value is displayed in green when both control outputs 1 and 2 are OFF.	Measured value is displayed in orange when both control outputs 1 and 2 are OFF.
ꠇꠇꠇꠇ *6	Measured value is displayed in orange when both control outputs 1 and 2 are OFF.	Measured value is displayed in green when both control outputs 1 and 2 are OFF.

- *1. If the tachometer output mode is set to AREA, however, the measured value is displayed in red when control output 1 is OFF and in green when control output 1 is ON.
- *2. If the tachometer output mode is set to AREA, however, the measured value is displayed in green when control output 1 is OFF and in red when control output 1 is ON.
- *3. If the tachometer output mode is set to AREA, however, the measured value is displayed in red when control output 1 is OFF and in orange when control output 1 is ON.
- *4. If the tachometer output mode is set to AREA, however, the measured value is displayed in orange when control output 1 is OFF and in red when control output 1 is ON.
- *5. If the tachometer output mode is set to AREA, however, the measured value is displayed in green when control output 1 is OFF and in orange when control output 1 is ON.
- *6. If the tachometer output mode is set to AREA, however, the measured value is displayed in orange when control output 1 is OFF and in green when control output 1 is ON.

Peak/bottom Hold Enabled (ꠇꠇꠇꠇ)

This function records the peak and bottom (i.e., minimum) after counting starts (after turning ON the power supply or changing the configuration selection mode or function setting). The peak value is also held when the power supply is interrupted.

Output Hysteresis (ꠇꠇꠇꠇ)

This setting can be used to prevent output chattering if the measurement value fluctuates slightly near the set value. The measurement value after prescaling is set.



Output OFF Delay (ꠇꠇꠇꠇ)

This function delays the timing for turning OFF comparative output by a certain time.

The ON time can be held for the set time if the comparative result changes in a short time.

Operation will continue and outputs will not change when holding the value.

Set Value Upper Limit (ꠇꠇꠇꠇ)

Set the upper limit for the set value when it is set in run mode. The limit can be set to between 1 and 999999.

Output Allocation (ꠇꠇꠇꠇ)

When using an H7CX-AU□-N model as 2-stage counter, each output can be flexibly allocated to either stage 1 or 2.

The transistor output can be allocated to SV1 and the contact output to SV2 or vice versa, as in the following tables.

H7CX-AU-N/AUD1-N

	Output 1	Output 2
ꠇꠇꠇꠇ	Transistor (12-13)	Contact (3, 4, 5)
ꠇꠇꠇꠇ	Contact (3, 4, 5)	Transistor (12-13)

H7CX-AUSD1-N

	Output 1	Output 2
ꠇꠇꠇꠇ	Transistor (12-13)	Transistor with diode (3, 4, 5)
ꠇꠇꠇꠇ	Transistor with diode (3, 4, 5)	Transistor (12-13)

Key Protect Level (ꠇꠇꠇꠇ)

Set the key protect level.

Refer to *Key Protect Level* on page page 36.

Pulse Cycle Measurement/Pulse Width Measurement (ꠇꠇꠇꠇ)

Set the measurement mode to pulse cycle measurement or pulse width measurement.

With pulse cycle measurement, the number of pulse cycles that occur in 1 s is measured.

With pulse width measurement, the ON time for one pulse is measured.

An input OFF period of at least 20 ms is required for pulse width measurement.

If there is no input pulse during pulse width measurement, the previously measured value will be held.

Display Unit (ꠇꠇꠇꠇ)

When pulse cycle measurement is used, set the display unit to Hz (hertz) or s (seconds).

Counting Interval (ꠇꠇꠇꠇ)

If the measurement speed is 10 kHz when pulse cycle measurement is used, set the measurement interval to 200 ms or Cont (10 ms min.).

H7CX-A□-N Tachometer

ON Count Alarm Set Values for Outputs 1 and 2 (OUT1 and OUT2) (ON 1# and ON2#)

Set the ON count alarm values for the outputs 1 and 2.

The limit can be set to between 0 × 1000 (0 times) and 9999 × 1000 (9,999,000 times). Only the underlined values are set. The alarm will be disabled if 0 is set.

If the total ON count of instantaneous output 1 or 2 exceeds the alarm set value, E3 will be displayed on the Timer to indicate that the output ON count alarm value was exceeded. Refer to *Self-diagnostic Function* on page 36 for information on the E3 display.

ON Count Monitor Values for Outputs 1 and 2 (OUT1 and OUT2) (ON 1# and ON2#)

The monitor value for output 1 or 2 is only displayed. It cannot be set. The output ON count will be 1,000 times the displayed value.

Operation in Run Mode Tachometer Operation

- Set each digit using the individual  Keys.



- *1 Measurement value 1 for the 2-input input mode.
- *2 Measurement value 2 for the 2-input input mode.
- *3 Peak/bottom hold enabled

Displayed when the input mode is not 2 inputs.



Displayed for the 2-input input mode.



- **Peak/bottom hold value**
The peak (maximum) and bottom (minimum) values are displayed after counting starts.
- **Peak/bottom hold value 2**
Peaks (maximums) 1 and 2 and bottoms (minimums) 1 and 2 are displayed after counting starts.

Note: The held values will be initialized when the Reset Key (Hold Key) or reset 1 input is turned OFF while peak/bottom hold values 1 and 2 are being displayed. (The reset 2 input operates in the same way if the input mode is set to 2-input mode.)

Output Mode Setting and Operation

Tachometer Operation

Input mode setting	Output mode setting	Operation									
1 input Error Absolute ratio Error ratio	Upper and lower limit (HI-LO)	<p>ON condition for OUT1: Measurement value \leq Comparison value 1 ON condition for OUT2: Measurement value \geq Comparison value 2</p>									
	Area (AREA)	<table border="1"> <thead> <tr> <th>Condition</th> <th>Comparison value 1 \leq Comparison value 2</th> <th>Measurement value 1 > Comparison value 2</th> </tr> </thead> <tbody> <tr> <td>ON condition for OUT1</td> <td>Comparison value 1 \leq Measurement value \leq Comparison value 2</td> <td>Comparison value 2 \leq Measurement value \leq Comparison value 1</td> </tr> <tr> <td>ON condition for OUT2</td> <td>Measurement value < Comparison value 1 or Measurement value > Comparison value 2</td> <td>Measurement value < Comparison value 2 or Measurement value > Comparison value 1</td> </tr> </tbody> </table>	Condition	Comparison value 1 \leq Comparison value 2	Measurement value 1 > Comparison value 2	ON condition for OUT1	Comparison value 1 \leq Measurement value \leq Comparison value 2	Comparison value 2 \leq Measurement value \leq Comparison value 1	ON condition for OUT2	Measurement value < Comparison value 1 or Measurement value > Comparison value 2	Measurement value < Comparison value 2 or Measurement value > Comparison value 1
	Condition	Comparison value 1 \leq Comparison value 2	Measurement value 1 > Comparison value 2								
	ON condition for OUT1	Comparison value 1 \leq Measurement value \leq Comparison value 2	Comparison value 2 \leq Measurement value \leq Comparison value 1								
ON condition for OUT2	Measurement value < Comparison value 1 or Measurement value > Comparison value 2	Measurement value < Comparison value 2 or Measurement value > Comparison value 1									
Upper limit (HI-HI)	<p>ON condition for OUT1: Measurement value \geq Comparison value 1 ON condition for OUT2: Measurement value \geq Comparison value 2</p>										
Lower limit (LO-LO)	<p>ON condition for OUT1: Measurement value \leq Comparison value 1 ON condition for OUT2: Measurement value \leq Comparison value 2</p>										
2 inputs	Upper limit (HI)	<div style="display: flex; justify-content: space-around;"> <div style="text-align: center;"> <p>Output 1</p> <p>ON condition for output 1: CP1 present value (display value) \geq Comparison value 1</p> </div> <div style="text-align: center;"> <p>Output 2</p> <p>ON condition for output 2: CP2 present value (display value) \geq Comparison value 2</p> </div> </div>									
	Lower limit (LO)	<div style="display: flex; justify-content: space-around;"> <div style="text-align: center;"> <p>Output 1</p> <p>ON condition for output 1: CP1 present value (display value) \leq Comparison value 1</p> </div> <div style="text-align: center;"> <p>Output 2</p> <p>ON condition for output 2: CP2 present value (display value) \leq Comparison value 2</p> </div> </div>									

Switching between Preset Counter, Total and Preset Counter, Batch Counter, Dual Counter, Twin Counter, and Tachometer Operation

Select which H7CX configuration is used (i.e., preset counter, total and preset counter, batch counter, dual counter, twin counter, or tachometer) in configuration selection mode.

The H7CX is also equipped with a DIP switch monitor function, a convenient function that enables the settings of the DIP switch pins to be confirmed using the display on the front of the H7CX.



Note

To change the mode to configuration selection mode, hold down the ≈ 1 Key for 1 s min. with the MODE Key held down. The mode will not change if the ≈ 1 Key is pressed first.

Select the configuration using the MODE Key.



*The configurations that can be selected depend on the model.

Note: By default, the H7CX is set to the 1-stage preset counter configuration. (Two-stage models are set to the 2-stage preset counter configuration.)

Confirm the status of DIP switch pins 1 to 8 using the MODE Key.

*This display is possible only when DIP switch pin 1 (DIP switch settings enable/disable) is set to ON (enable).

Example



*1 When the mode is changed to configuration selection mode, the present value is reset, outputs turn OFF, and counting (measuring) stops.

*2 Setting changes made in configuration selection mode are enabled when the mode is changed to run mode. If the configuration is changed, the set value (or set value 1 and set value 2), comparison value 1 and comparison value 2 are initialized.

Hold Function

The measurement value (display value) and output are sustained while the hold input is ON.

Note: The output will maintain the current status when the hold key is pressed.

Example:



Key Protect Level

It is possible to prevent setting errors by prohibiting the use of certain operation keys by specifying the key protect level (KP-1 to KP-7) when the key-protect switch is set to ON.

The key protect level is set in the function setting mode. The key protect indicator is lit when the key-protect switch is ON.



Level	Description	Details			
		Changing modes*	Switching display during operation	Reset Key	Up/Down Keys
KP-1 (default setting)		Invalid	Valid	Valid	Valid
KP-2		Invalid	Valid	Invalid	Valid
KP-3		Invalid	Valid	Valid	Invalid
KP-4		Invalid	Valid	Invalid	Invalid
KP-5		Invalid	Invalid	Invalid	Invalid
KP-6		Invalid	Invalid	Valid	Valid
KP-7		Invalid	Invalid	Invalid	Valid

* Changing mode to configuration selection mode or function setting mode.

Self-diagnostic Function

The following displays will appear if an error occurs.

Main display	Sub-display	Description	Output status	Correction method	Set value after reset
----- (----)*1*5	No change	Present value underflow*3	No change	Either press the Reset Key or turn ON reset input.	No change
FFFFF (FFFF)*1*5	No change	Present value overflow*4	No change	Either press the Reset Key or turn ON reset input.*6	No change
E I	Not lit	CPU error	OFF	Either press the Reset Key or reset the power supply.	No change
E 2	Not lit	Memory error (RAM)	OFF	Turn ON the power again.	No change
E 2	5U _n	Memory error (EEPROM)*2	OFF	Reset Key	Factory setting
E 3*8	No change	Output Counter Overflow	No change	Reset Key*7	No change

*1. Displays for 4-digit models are given in parentheses.

*2. This includes times when the life of the EEPROM has expired.

*3. This occurs if the present value or total count value falls below -99999 (-999 for 4-digit models).

*4. This occurs in the following conditions if the present value (i.e., measurement value) exceeds 999999 (9999 for 4-digit models).

- For Output Modes K-2, D, L, or H
- Dual counter or tachometer operation is used.

*5. Display flashes.(1-second cycles)

*6. This does not apply when tachometer operation is used.

*7. This is displayed if the alarm value setting for either of the two outputs is exceeded if a model with two outputs is used.The total ON count will not be cleared by using the Reset Key.

*8. The normal display and E 3 will appear alternately.

When the Reset Key is pressed, E 3 will not be displayed even if the alarm set value is exceeded.
(Monitoring is possible, however, because the counter will continue without the output ON count being cleared.)

H7CX-R□-N Tachometer



- Tachometer-only model (DIN 48 × 48) for the H7CX (Supports display and alarm outputs for numbers of rotations, speed, and flow rate.)
- Socket design allows either flush or surface mounting.
- "-W" models added to provide two sets of measurement controls.
- Operation in any of the four following modes is possible with the same Unit: Upper and lower limit, upper limit, lower limit, and area.
- Equipped with auto-zero time, average processing, and startup time functions.

* The prescale value and auto-zero time settings are one.

For the most recent information on models that have been certified for safety standards, refer to your OMRON website.

Specifications

Ratings

Item	Classification Model	Tachometer			
		H7CX-R11□-N		H7CX-R11W□-N	
Input mode		1 input only		2 inputs only	
Ratings	Power supply voltage ^{*1}	<ul style="list-style-type: none"> • 100 to 240 VAC, 50/60 Hz • 12 to 24 VDC or 24 VAC, 50/60 Hz 			
	Operating voltage fluctuation range	85% to 110% of rated supply voltage (90% to 110% at 12 to 24 VDC)			
	Power consumption	Approx. 9.4 VA at 100 to 240 VAC, Approx. 7.2 VA/4.7 W at 24 VAC/12 to 24 VDC, Approx. 3.7 W at 12 to 24 VDC			
Mounting method		Flush mounting or surface mounting			
External connections		11-pin socket			
Degree of protection		IEC IP66, UL508 Type 4 (indoors) for panel surface only and when Y92S-29 Waterproof Packing is used			
Input signals		Count and hold		Count 1 and count 2	
Pulse measurement method		Tachometer mode (cycle measurement)	AMD-compatible mode (continuous measurement)		Tachometer mode (cycle measurement)
Maximum counting speed		30 Hz (minimum pulse width: 16.7 ms)	10 kHz (minimum pulse width: 0.05 ms)	---	
Minimum input signal width		---		10 ms	1 ms
Measuring ranges		0.001 Hz to 30.00Hz	0.001 Hz to 10 kHz	0.026 to 999999 s	0.003 to 999999 s
Sampling cycle		200 ms min.		Continuous measurement (minimum interval of 10 ms)	
Display refresh cycle		<ul style="list-style-type: none"> • Input pulse of 5 Hz min. Averaging not used: 200 ms • Averaging used: 200 multiplied by the averaging setting (ms) • Input pulse of less than 5 Hz • Averaging not used: Two times the maximum input pulse cycle • Using averaging: Two times the maximum of the input pulse cycle multiplied by the averaging setting. 			
Measuring accuracy		±0.1% FS ±1 digit max. (at 23 ±5°C)			
Output mode		HI-LO, AREA, HI-HI, LO-LO		HI-HI, LO-LO	
Auto-zero time		0.1 to 999.9 s (in Tachometer Mode)			
Startup time		0.0 to 99.9 s			
Averaging		Simple averaging/moving averaging selectable, Number of times: OFF, 2, 4, or 8 times			
Prescaling function		0.001 to 99.999 (in Tachometer Mode)			
Decimal point adjustment		Rightmost 3 digits		---	
Sensor waiting time		290 ms max. (Control output is turned OFF and no input is accepted during sensor waiting time.)			
Input	Input method	No-voltage Input Impedance when ON: 1 kΩ max. (Leakage current: 12 mA when 0 Ω) ON residual voltage: 3 V max. Impedance when OFF: 100 kΩ min. Voltage Input High (logic) level: 4.5 to 30 VDC Low (logic) level: 0 to 2 VDC (Input resistance: approx. 4.7 kΩ) No-voltage input/voltage input (selectable)			
	Hold input	Minimum input signal width: 20 ms		---	
External power supply		12 VDC (±10%), 100 mA * Refer to <i>Safety Precautions (Common)</i> on page 52 for details.			
Control output		Contact output: 3 A at 250 VAC/30 VDC, resistive load (cosφ=1) Minimum applied load: 10 mA at 5 VDC (failure level: P, reference value)			
Display*2		7-segment, negative transmissive LCD Character height Present value: 10 mm (red), comparison value: 6 mm (green)			
Digits		6 digits (0 to 999999)			
Memory backup		EEPROM (overwrites: 100,000 times min.) that can store data for 10 years min.			
Operating temperature range		-10 to 55°C (-10 to 50°C if Counter/Tachometers are mounted side by side) (with no icing or condensation)			
Storage temperature range		-25 to 70°C (with no icing or condensation)			
Operating humidity range		25% to 85%			
Case color		Black (N1.5)			

*1. Do not use the output from an inverter as the power supply. The ripple must be 20% maximum for CC power.

*2. The display is lit only when the power is ON. Nothing is displayed when power is OFF.

Characteristics

Insulation resistance	100 MΩ min. (at 500 VDC) between current-carrying terminal and exposed non-current-carrying metal parts, and between non-continuous contacts
Dielectric strength	2,000 VAC, 50/60 Hz for 1 min between current-carrying metal parts and non-current-carrying metal parts 2,000 VAC (for 100 to 240 VAC), 50/60 Hz for 1 min between power supply and input circuit (1,000 VAC for 24 VAC/12 to 24 VDC) 2,000 VAC 50/60 Hz for 1 min between control output, power supply, and input circuit 1,000 VAC, 50/60 Hz for 1 min between non-continuous contacts
Impulse withstand voltage	3.0 kV (between power terminals) for 100 to 240 VAC, 1.0 kV for 24 VAC/12 to 24 VDC 4.5 kV (between current-carrying terminal and exposed non-current-carrying metal parts) for 100 to 240 VAC, 1.5 kV for 24 VAC/12 to 24 VDC
Noise immunity	±1.5 kV (between power terminals) ±600 V (between input terminals) Square-wave noise by noise simulator (pulse width: 100 ns/1 μs, 1-ns rise)
Static immunity	Destruction: 15 kV, Malfunction: 8 kV
Vibration resistance	Destruction 10 to 55 Hz with 0.75-mm single amplitude, each in three directions for 2 hours Malfunction 10 to 55 Hz with 0.35-mm single amplitude, each in three directions for 10 min
Shock resistance	Destruction 300m/s ² each in three directions, three cycles Malfunction 100m/s ² each in three directions, three cycles
Life expectancy	Mechanical: 10,000,000 operations min. Electrical: 100,000 operations min. (3 A at 250 VAC, resistive load, ambient temperature condition: 23°C) *
Weight	Approx. 110 g (Tachometer only)

* See Life-test Curve (Reference Values) on the right.

Applicable Standards

Approved safety standards	cULus (or cURus): UL508/CSA C22.2 No. 14* Conforms to EN 61010-1 (IEC 61010-1): Pollution degree 2/overvoltage category II, B300 PILOT DUTY, 1/4 HP 120 VAC, 1/3 HP, 240 VAC, 3-A resistive load	
EMC	(EMI)	EN61326
	Emission Enclosure:	EN55011 Group 1 classA
	Emission AC mains:	EN55011 Group 1 classA
	(EMS)	EN61326
	Immunity ESD:	EN61000-4-2: 4 kV contact discharge (level 2); 8 kV air discharge (level 3)
	Immunity RF-interference:	EN61000-4-3: 10 V/m (Amplitude-modulated, 80 MHz to 1 GHz) (level 3); 10 V/m (Pulse-modulated, 900 MHz ±5 MHz) (level 3)
	Immunity Conducted Disturbance:	EN61000-4-6: 10 V (0.15 to 80 MHz) (level 3)
	Immunity Burst:	EN61000-4-4: 2 kV power-line (level 3); 1 kV I/O signal-line (level 4)
	Immunity Surge:	EN61000-4-5: 1 kV line to lines (power and output lines) (level 2); 2 kV line to ground (power and output lines) (level 3)
	Immunity Voltage Dip/Interruption:	EN61000-4-11: 0.5 cycle, 100% (rated voltage)

* The following safety standards apply to the H7CX-R11□.
cUL (Listing): Applicable when an OMRON P2CF(-E) Socket is used.
cUR (Recognition): Applicable when any other socket is used.

I/O Functions

Inputs	Count, count 1, count 2	Reads counting signals.
	Hold	<ul style="list-style-type: none"> • Holds the measurement value and outputs. • The hold indicator is lit during hold.*
Outputs	OUT	Outputs signals according to the specified output mode when a comparison value is reached.

* Refer to page 50 for details on the hold function.

- The following table shows the delay from when the reset signal is input until the output is turned OFF. (Reference values)

Minimum reset signal width	Output delay time
1 ms	0.8 to 1.2 ms
20 ms	15 to 25 ms

Life-test Curve (Reference Values) Resistive Load



Inductive Load



A current of 0.15 A max. can be switched at 125 VDC (cosφ=1) (Life expectancy: 100,000 operations)
A current of 0.1 A max. can be switched if L/R=7 ms. (Life expectancy: 100,000 operations)

Connections

Terminal Arrangement

H7CX-R11-N
H7CX-R11D1-N



* The hold function is the same whichever terminal is connected. Terminals are not connected internally, and so do not use them for cross-over wiring.

H7CX-R11W-N
H7CX-R11WD1-N



Block Diagram



Input Circuits

Count and Hold Inputs

No-voltage Inputs (NPN Inputs)



Voltage Inputs (PNP Inputs)



Input Connections

The inputs of the H7CX-R are no-voltage (short-circuit or open) inputs or voltage inputs. They are set for use as voltage inputs at the time of delivery.

No-voltage Inputs (NPN Inputs)

Open Collector

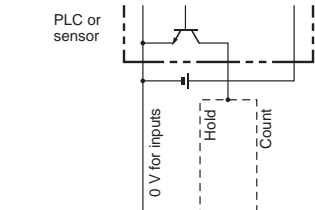

H7CX-R11□	3	4	5	7	6
H7CX-R11W□	3	---	---	---	6

Note: Operates when the transistor turns ON.

Voltage Output



H7CX-R11□	3	4	5	7	6
H7CX-R11W□	3	---	---	---	6

Note: Operates when the transistor turns ON.

Contact Input

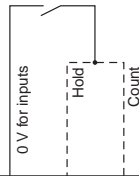

H7CX-R11□	3	4	5	7	6
H7CX-R11W□	3	---	---	---	6

Note: Operate when the contact turns ON.

DC Two-wire Sensor

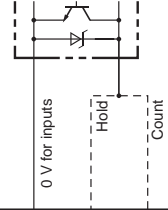

H7CX-R11□	3	4	5	7	6
H7CX-R11W□	3	---	---	---	6

Note: Operates when the transistor turns ON.

No-voltage Input Signal Levels

No-contact input	Short-circuit level (Transistor ON)
	<ul style="list-style-type: none"> Residual voltage: 3 V max. Impedance when ON: 1 kΩ max. (The leakage current is approx. 12 mA when the impedance is 0 Ω.)
Contact input	Open level (Transistor OFF)
	<ul style="list-style-type: none"> Impedance when OFF: 100 kΩ min.

Note: The DC voltage must be 30 VDC max.

Applicable Two-wire Sensor

- Leakage current: 1.5 mA max.
- Switching capacity: 5 mA min.
- Residual voltage: 3 VDC max.
- Operating voltage: 10 VDC

Voltage Inputs (PNP Inputs)

No-contact Input (NPN Transistor)

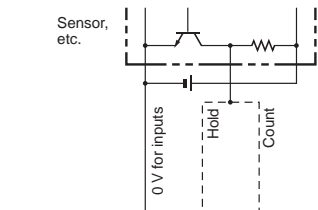

H7CX-R11□	3	4	5	7	6
H7CX-R11W□	3	---	---	---	6

Note: Operate when the transistor turns OFF.

No-contact Input (PNP Transistor)

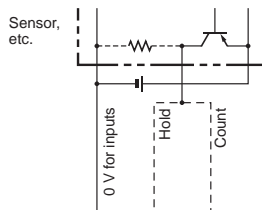

H7CX-R11□	3	4	5	7	6
H7CX-R11W□	3	---	---	---	6

Note: Operate when the transistor turns ON.

Contact Input

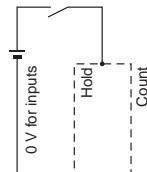

H7CX-R11□	3	4	5	7	6
H7CX-R11W□	3	---	---	---	6

Note: Operate when the contact turns ON.

Voltage Input Signal Levels

High level (Input ON): 4.5 to 30 VDC
Low level (Input OFF): 0 to 2 VDC

- Note:**
- The DC voltage must be 30 VDC max.
 - Input resistance: Approx. 4.7 kΩ

Nomenclature

Display Section

1. **Hold Indicator** (orange)
(Lit when the hold input or hold key is ON.)
2. **Key Protect Indicator** (orange)
Lit when the key protect switch is ON.
3. **Control Output Indicator** (orange)
OUT (1-output models)
OUT 1 2 (2-output models)
4. **Comparison Value 1, 2 Stage Indicator**
5. **Present Value (Main Display)**
Character height: 10 mm (red)
6. **Comparison Value (Sub-display)**
Character height: 6 mm (green)

Character Size for Main Display



Character Size for Sub-display

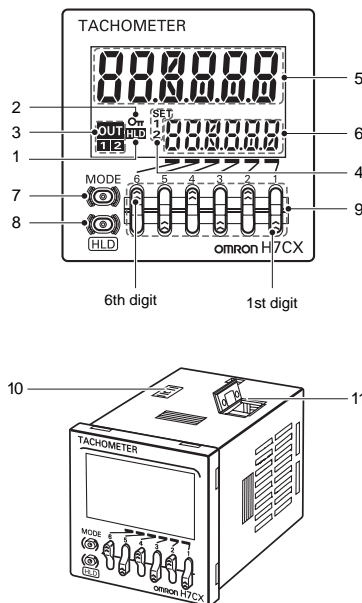

Operation Keys

7. **Mode Key**
(Used to switch mode and setting items.)
8. **Hold Key**
(Used to sustain the measurement value and output.)
9. **Up Keys** 1 to 6

Switches

10. Key-protect Switch

(Factory setting) OFF ← ON
(Disable) (Enable)



11. DIP Switch

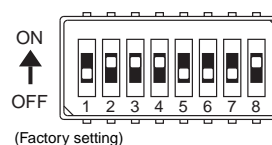

Dimensions

(Unit: mm)

Tachometers

Dimensions without Flush Mounting Adapter

H7CX-R□-N

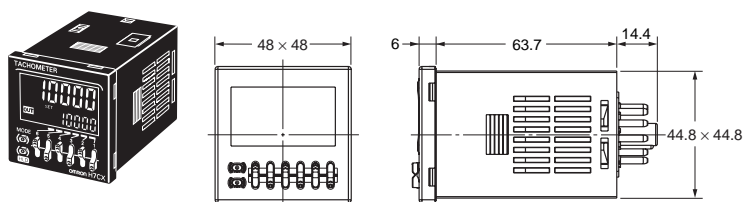

Panel Cutouts

Panel cutouts are as shown below (according to DIN43700).

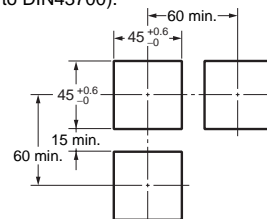

- Note:**
1. The mounting panel thickness should be 1 to 5 mm.
 2. To allow easier operation, it is recommended that Adapters be mounted so that the gap between sides with hooks is at least 15 mm (i.e., with the panel cutouts separated by at least 60 mm).
 3. It is possible to horizontally mount Timers side by side. Attach the Flush Mounting Adapters so that the surfaces without hooks are on the sides of the Timers. If Counters/Tachometers are mounted side by side, however, water resistance will be lost.

Dimensions with Flush Mounting Adapter (Adapter and Waterproof Packing Ordered Separately)

H7CX-R□-N

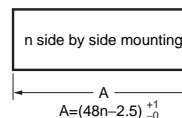
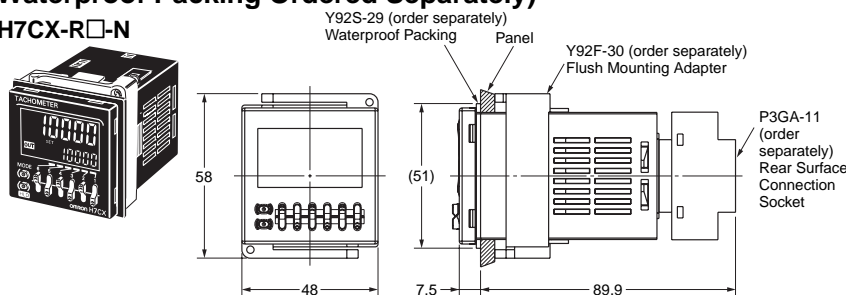

With Y92A-48F1 attached.
 $A = (48n - 2.5 + (n-1) \times 4) +1 -0$
 With Y92A-48 attached.
 $A = (51n - 5.5) +1 -0$

Dimensions with Front Connecting Socket

H7CX-R□-N

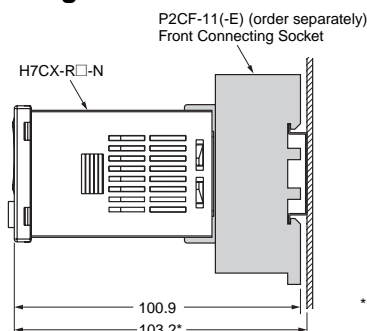

* These dimensions vary with the kind of DIN track (reference value).

Accessories (Order Separately)

Note: Depending on the operating environment, the condition of resin or rubber products may deteriorate, or they may shrink or become harder. Therefore, it is recommended that resin products be replaced regularly.

Soft Cover

Y92A-48F1

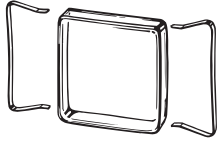

Protecting the Timer in Environments Subject to Oil

The H7CX's panel surface is water-resistant (conforming to IP□6, UL Type 4X) and so even if drops of water penetrate the gaps between the keys, there will be no adverse effect on internal circuits. If, however, there is a possibility of oil being present on the operator's hands, use the Soft Cover. The Soft Cover ensures protection equivalent to IP54 against oil. Do not, however, use the H7CX in locations where it would come in direct contact with oil.

Hard Cover

Y92A-48

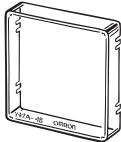

Flush Mounting

Adapter

Y92F-30

Order a Flush Mounting Adapter separately if the product is to be flush-mounted.

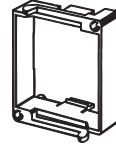

Y92F-45

Use this Adapter to install the Counter/Tachometer in a cutout previously made for a DIN 72 × 72 mm device (panel cutout: 68 × 68 mm).

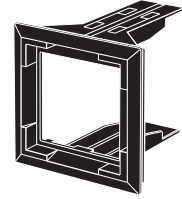

Waterproof Packing

Y92S-29

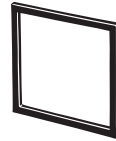

Order the Waterproof Packing separately if it is lost or damaged. The Waterproof Packing can be used to achieve protection equivalent to IP66.

(The Waterproof Packing will deteriorate, harden, and shrink depending on the application environment. To ensure maintaining the NEMA4 waterproof level, periodically replace the Waterproof Packing. The periodic replacement period will depend on the application environment. You must confirm the proper replacement period. Use 1 year or less as a guideline. If the Waterproof Packing is not replaced periodically, the waterproof level will not be maintained.) It is not necessary to mount the Waterproof Packing if waterproof construction is not required.

Connection Sockets

Refer to *Connection Sockets* on page page 13 for details.

Optional Products for Track Mounting

Refer to *Optional Products for Track Mounting* on page page 14 for details.

Operating Procedures

Parameters must be set using both the DIP switch and the operation keys on the front panel. Refer to the following for the detailed procedure.

Step1

Set the basic parameters.



	Item	OFF	ON
1	Input mode ^{*1}		
2	Counting speed/ Minimum input signal width	Refer to the table on the right.	
3	Output mode ^{*2}	Refer to the table on the right.	
5	Average processing	Refer to the table on the right.	
7	---	---	---
8	NPN/PNP input mode	NPN	PNP

Note: The characters displayed in reverse video are the default settings.

The settings made using the DIP switch can be checked in the DIP switch monitor mode.

Pin 1	Pin 2	Input mode	Counting speed/ minimum input signal width
OFF	OFF	Tachometer	30 Hz
ON	OFF	AMD compatible	10 ms
OFF	ON	Tachometer	10 kHz ^{*3}
ON	ON	AMD compatible	1 ms

Pin 6	Pin 4	Output mode
OFF	OFF	Upper and lower limit
ON	OFF	Area
OFF	ON	Upper limit
ON	ON	Lower limit

Pin 5	Pin 6	Average processing
OFF	OFF	OFF (no average processing)
ON	OFF	2 times
OFF	ON	4 times
ON	ON	8 times

*1. The setting of Pin 1 is disabled (OFF) for the H7CX-R11W□.

*2. For the H7CX-R11W□.

	Item	OFF	ON
3	Output 1 mode	Refer to the table on the right.	
4	Output 2 mode	Refer to the table on the right.	

Note: The characters displayed in reverse video are the default settings.

*3. For the H7CX-R11W□, the counting speed will be 5 kHz even if 10 kHz is selected.

Pin 3	Output mode
OFF	Upper limit
ON	Lower limit

Pin 4	Output mode
OFF	Upper limit
ON	Lower limit

• DIP switch settings are effective when the power is turned ON again. (Perform DIP switch settings while the power is OFF.)

Step2

Change to Function Setting Mode.



For details on operations in run mode, refer to page page 47.

- *1 If the mode is switched to the function setting mode during operation, operation will continue.
- *2 Changes made to settings in function setting mode are enabled for the first time when the mode is changed to run mode. Also, when settings are changed, the counter is reset (measured values initialized and output turned OFF) on returning to run mode.



The characters displayed in reverse video are the default settings.

• Set the decimal point position using the Key.
 (No decimal point) (One digit after decimal point) (Two digits after decimal point) (Three digits after decimal point)

• Set each digit using the individual Key.
 (0.001) (1.000) (99.999)

Note: Not displayed in AMD-compatible mode.

• Set the averaging method using the Key.
 (SMP) (MV)

Note: SMP: Simple averaging, MV: Moving average

• Set each digit using the individual Key.
 (0.1 s) (999.9 s)

Note: Not displayed in AMD-compatible mode.

• Set each digit using the individual Key.
 (0.0 s) (99.9 s)

• Enable or disable peak/bottom hold using the Key.
 (Disabled) (Enabled)

• Set the output hysteresis using the Key.
 (0) (99999)

Note: The measurement value after prescaling is set.

• Set each digit using the individual Key.
 (0.00 s) (19.99 s)

• Set each digit using the individual Key.
 (1) (999999)

• Set the key protect level using the Key.
 (KP-1) (KP-2) (KP-3) (KP-4) (KP-5) (KP-6) (KP-7)

*1 Set each digit using the individual Key.

Procedure for Models Other than "R11W□" Models



Procedure for "R11W□" Models

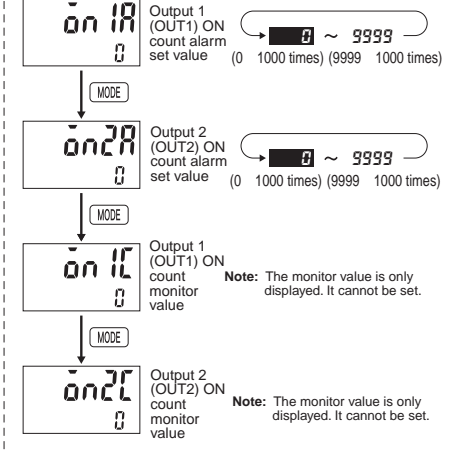

Explanation of Functions

Basic Functions

Input Mode

The mode can be switched between tachometer mode and AMD-compatible mode.

Tachometer Mode

Use this mode to measure the pulse frequency (Hz).

AMD-compatible Mode

Use this mode to measure the pulse cycle (s).



Counting Speed

Set the maximum counting speed (30 Hz/10 kHz) for input. If contacts are used for input signals, set the counting speed to 30 Hz. Processing to eliminate chattering is performed for this setting.

Output Mode

Set the output method for control output based on the comparison value.

Upper and lower limit (HI-LO), area (AREA), upper limit (HI), and lower limit (LO) can be set. For the H7CX-RW□, the upper limit (HI-HI) and lower limit (LO-LO) can be set. (For details on the operation of the output modes, refer to *Output Mode Settings* on page page 49.)

Averaging Method (平均法)

Simple averaging (SMP) or a moving average (MV) can be selected for the averaging method.

With a moving average, the average measurement value is displayed every sampling cycle or pulse cycle, in contrast to simple averaging, for which the average value is displayed for the set number of samples.

Number of Averaging Times

Flickering display and output chattering can be prevented using average processing. Average processing can be set to one of four levels: no average processing, 2 times (i.e., the average of 2 measurement values), 4 times, or 8 times.

For a measurement frequency of 5 Hz or higher using a tachometer, the average will be equal to the sampling cycle (200 ms) multiplied by the averaging setting (i.e., the number of times).

For less than 5 Hz, the frequency will be measured when the input pulse comes. Average processing produces a stable display even for fluctuating input signals. Set the optimum number of times for the application.

If AMD-compatible mode is used, the measurement cycle will be measured when the input pulse is received. The output will change, however, when the comparison value is exceeded even if averaging is enabled.

NPN/PNP Input Mode

Select either NPN input (no-voltage input) or PNP input (voltage input) as the input format. When using a two-wire sensor, select NPN input.

The same setting is used for all external inputs.

For details on input connections, refer to *Input Connections* on page page 40.

Advanced Functions

Decimal Point Position (dP)

Decide the decimal point position for the measurement value and comparison value.

Prescale Value (P5L)

It is possible to display the rate of rotation or the speed of a device or machine to which the H7CX is mounted by converting input pulses to a desired unit.

If the default prescaling value (1,000) is used, the input frequency (Hz) will be displayed.

The relationship between display and input is determined by the following equation. Set the prescale value according to the unit to be displayed.

$$\text{Displayed value} = f \times \alpha$$

f: Input pulse frequency (number of pulses in 1 second)

α : Prescale value

(1) Displaying Rotation Rate

Display unit	Prescale value (α)
rpm	$1/N \times 60$
rps	$1/N$

N: Number of pulses per revolution

Example: In order to display the rate of rotation for a machine that outputs 5 pulses per revolution in the form □□.□ rpm:

1. Set the decimal point position to 1 decimal places.

2. Using the formula, set the prescale value (α) to

$$1/N \times 60 = 60/5 = 12.$$

(2) Displaying Speed

Display unit	Prescale value (α)
m/min	$\pi d \times 1/N \times 60$
m/s	$\pi d \times 1/N$

N: Number of pulses per revolution

d: Diameter of rotating body (m)

πd : Circumference (m)



- Observe the following points when setting a prescale value.

Set the set value to a value less than {Maximum countable value – Prescale value}.

Example: If the prescale value is 1.25 and the counting range is 0.000 to 999.999, set the set value to a value less than 998.749 (= 999.999 – 1.25).

If the set value is set to a value greater than this, output will not turn ON.

Note: If the prescale value setting is incorrect, a counting error will occur. Check that the settings are correct before using this function.

Auto-zero Time (R0T00)

It is possible to make the settings so that the frequency will be forced to 0 if there is no pulse for a specified period of time. This time is called the auto-zero time.

Note: Set the auto-zero time to a time slightly longer than the estimated interval between input pulses. It will not be possible to make accurate measurements if the auto-zero time is set to a time shorter than the input pulse cycle. Setting a time that is too long may also result in problems, such as a time-lag between rotation stopping and the alarm turning ON.

Startup Time (5t nr)

In order to prevent undesired output resulting from unstable input immediately after the power supply is turned ON, measurement can be prohibited for a set time at startup.

It can also be used to stop measurement and disable output until the rotating body reaches the normal rate of rotation, after the power supply to the H7CX and rotating body are turned ON at the same time.



Peak/bottom Hold Enabled (dHL d)

This function records the peak and bottom (i.e., minimum) values after counting starts (after turning ON the power supply or changing the configuration selection mode or function setting).

The peak value is also held when the power supply is interrupted.

Output Hysteresis (HY5)

This setting can be used to prevent output chattering if the measurement value fluctuates slightly near the set value.

In Thachometer Mode, the measurement value after prescaling is set.



Output OFF Delay (OFF d)

This function delays the timing for turning OFF comparative output by a certain time.

The ON time can be held for the set time if the comparative result changes in a short time.

Operation will continue and outputs will not change while holding the value.

Set Value Upper Limit (5L -H)

Set the upper limit for the set value when it is set in run mode.

Key Protect Level (YPL)

Set the key protect level.

Refer to *Key Protect Level* on page 48.

Output ON Count Alarm Set Value (ON-R)

Set the alarm value for the output ON count.

The limit can be set to between 0×1000 (0 times) and 9999×1000 (9,999,000 times). Only the underlined values are set. The alarm will be disabled if 0 is set.

If the total ON count of the output exceeds the alarm set value, E3 will be displayed on the Timer to indicate that the output ON count alarm value was exceeded. Refer to *Self-diagnostic Function* on page 48 for information on the E3 display.

ON Count Alarm Set Values for Outputs 1 and 2 (OUT1 and OUT2) (ON-R and ON-R)

Set the ON count alarm values for the outputs 1 and 2.

The limit can be set to between 0×1000 (0 times) and 9999×1000 (9,999,000 times). Only the underlined values are set. The alarm will be disabled if 0 is set.

If the total ON count of instantaneous output 1 or 2 exceeds the alarm set value, E3 will be displayed on the Timer to indicate that the output ON count alarm value was exceeded. Refer to *Self-diagnostic Function* on page 48 for information on the E3 display.

Output ON Count Monitor Value (ON-L)

The monitor value is only displayed. It cannot be set.

The output ON count will be 1,000 times the displayed value.

ON Count Monitor Values for Outputs 1 and 2 (OUT1 and OUT2) (ON-L and ON-L)

The monitor value for output 1 or 2 is only displayed. It cannot be set.

The output ON count will be 1,000 times the displayed value.

Operation in Run Mode

- Set each digit using the individual  Keys.

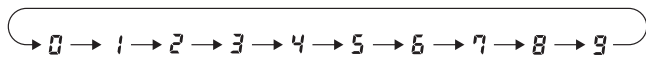

H7CX-R11□-N

Output Mode: HI or LO

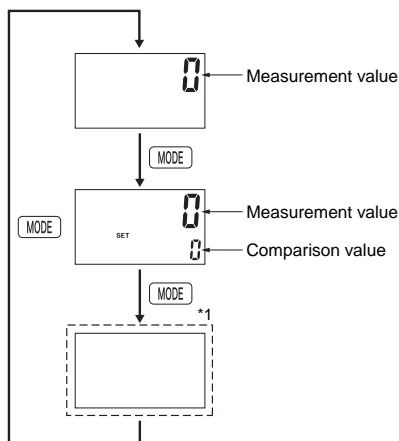

Output Mode: HI-LO or AREA

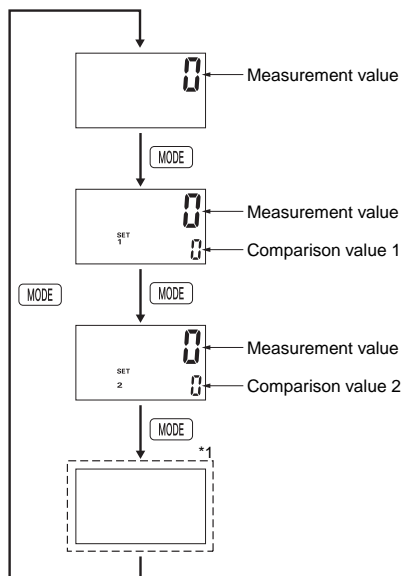

- **Measurement Value**
Displays the currently measured value.
- **Comparison Value, Comparison Value 1, and Comparison Value 2**
Set the comparison value, comparison value 1, and comparison value 2.
The measurement value is compared to comparison value, comparison value 1, and comparison value 2 and an output is made according to the selected output mode.

H7CX-R11W□-N

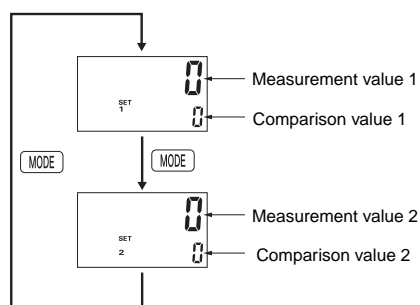

*1 Peak/bottom hold enabled

Displayed for Models Other Than "-W" Models



Displayed for "-W" Models

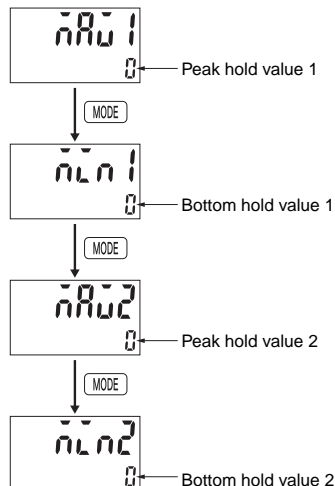

- **Peak/bottom hold value**
The peak (maximum) and bottom (minimum) values are displayed after counting starts.
 - **Peak/bottom hold value 2**
Peaks (maximums) 1 and 2 and bottoms (minimums) 1 and 2 are displayed after counting starts.
- Note:** The held values will be initialized when the Hold Key or reset 1 input is turned OFF while peak/bottom hold values 1 and 2 are being displayed. (The reset 2 input operates in the same way if the input mode is set to 2-input mode.)

Key Protect Level

When the key-protect switch is set to ON, it is possible to prevent setting errors by prohibiting the use of certain operation keys by specifying the key protect level (KP-1 to KP-7). The key protect level is set in the function setting mode. The key protect indicator is lit when the key-protect switch is ON.



Level	Meaning	Details			
		Changing mode*	Switching display during operation	Hold Key	Up Key
KP-1 (default setting)		Invalid	Valid	Valid	Valid
KP-2		Invalid	Valid	Invalid	Valid
KP-3		Invalid	Valid	Valid	Invalid
KP-4		Invalid	Valid	Invalid	Invalid
KP-5		Invalid	Invalid	Invalid	Invalid
KP-6		Invalid	Invalid	Valid	Valid
KP-7		Invalid	Invalid	Invalid	Valid

* Changing mode to DIP switch monitor mode or function setting mode.

Self-diagnostic Function

The following displays will appear if an error occurs.

Main display	Sub-display	Error	Output status	Correction method	Set value after reset
FFFFF *3	No change	Measurement value overflow*2	No change	Measurement value ≤ 999999	No change
E1	Not lit	CPU	OFF	Either press the hold key or reset the power supply.	No change
E2	Not lit	Memory error (RAM)	OFF	Turn ON the power again.	No change
E2	5U _m	Memory error (EEP)*1	OFF	Hold Key	Factory setting
E3 *4	No change	Output Counter Overflow	No change	Hold Key	No change

*1. This includes times when the life of the EEPROM has expired.

*2. Occurs when the measurement value reaches 999,999.

*3. Display flashes (1-second cycles).

*4. The normal display and E3 will appear alternately.

When the Hold Key is pressed, E3 will not be displayed even if the alarm set value is exceeded. (Monitoring is possible, however, because the counter will continue without clearing the output ON count.)

Output Mode Settings

Models Other Than H7CX-R11W□ in Tachometer Mode

Output mode setting	Operation						
Upper and lower limit	<p>ON condition: Measurement value \leq Comparison value 1 or Measurement value \geq Comparison value 2 Note: When comparison value 1 \geq comparison value 2, the output is always ON regardless of the comparison value.</p>						
Area	<table border="1"> <tr> <td>Condition</td> <td>Comparison value 1 \leq Comparison value 2</td> <td>Comparison value 1 $>$ Comparison value 2</td> </tr> <tr> <td>ON condition</td> <td>Comparison value 1 \leq measurement value \leq Comparison value 2</td> <td>Comparison value 2 \leq measurement value \leq Comparison value 1</td> </tr> </table>	Condition	Comparison value 1 \leq Comparison value 2	Comparison value 1 $>$ Comparison value 2	ON condition	Comparison value 1 \leq measurement value \leq Comparison value 2	Comparison value 2 \leq measurement value \leq Comparison value 1
Condition	Comparison value 1 \leq Comparison value 2	Comparison value 1 $>$ Comparison value 2					
ON condition	Comparison value 1 \leq measurement value \leq Comparison value 2	Comparison value 2 \leq measurement value \leq Comparison value 1					
Upper limit	<p>ON condition: Measurement value \geq Comparison value</p>						
Lower limit	<p>ON condition: Measurement value \leq Comparison value</p>						

Models Other Than H7CX-R11W□ in AMD-compatible Mode

Output mode setting	Operation						
Upper and lower limit	<p>ON condition: Measurement value $<$ Comparison value 1 or Measurement value \geq Comparison value 2 Note: When comparison value 1 \geq comparison value 2, the output is always ON regardless of the comparison value.</p>						
Area	<table border="1"> <tr> <td>Condition</td> <td>Comparison value 1 \leq Comparison value 2</td> <td>Comparison value 1 $>$ Comparison value 2</td> </tr> <tr> <td>ON condition</td> <td>Comparison value 1 \leq measurement value $<$ Comparison value 2</td> <td>Comparison value 2 \leq measurement value $<$ Comparison value 1</td> </tr> </table>	Condition	Comparison value 1 \leq Comparison value 2	Comparison value 1 $>$ Comparison value 2	ON condition	Comparison value 1 \leq measurement value $<$ Comparison value 2	Comparison value 2 \leq measurement value $<$ Comparison value 1
Condition	Comparison value 1 \leq Comparison value 2	Comparison value 1 $>$ Comparison value 2					
ON condition	Comparison value 1 \leq measurement value $<$ Comparison value 2	Comparison value 2 \leq measurement value $<$ Comparison value 1					
Upper limit	<p>ON condition: Measurement value \geq Comparison value</p>						
Lower limit	<p>ON condition: Measurement value $<$ Comparison value</p>						

Note: If time "a" is exceeded during operation, the output will turn ON. If time "b" is exceeded during operation, the output will turn OFF. (If average processing is enabled, the output operation will be performed when the time is exceeded once.)

H7CX-R11W□

Output mode setting	Operation
Upper limit (HI)	<p>ON condition for output 1: CP1 present value (display value) \geq Comparison value 1 ON condition for output 2: CP2 present value (display value) \geq Comparison value 2</p>
Lower limit (LO)	<p>ON condition for output 1: CP1 present value (display value) \leq Comparison value 1 ON condition for output 2: CP2 present value (display value) \leq Comparison value 2</p>

Precautions for the H7CX-R

In upper and lower limit output mode, if the comparison value setting is such that comparison value 1 \geq comparison value 2, the output will always be ON.

Hold Function

The measurement value (display value) and output are sustained while the hold input is ON.

Note: The output will maintain the current status when the hold key is pressed.

Example:



* The H7CX-R11W□-N does not have a hold input.

Operation in DIP Switch Monitor Mode

The H7CX-R is also equipped with a DIP switch monitor function, a convenient function that enables the settings of the DIP switch pins to be confirmed using the front display.



Precautions on Replacing the AMD-S

The H7CX-R11-N is the recommended model for replacing the AMD-S-series Motion Detector. Refer to the following precautions before replacing the AMD-S.

Terminal Arrangement and Wiring Connections

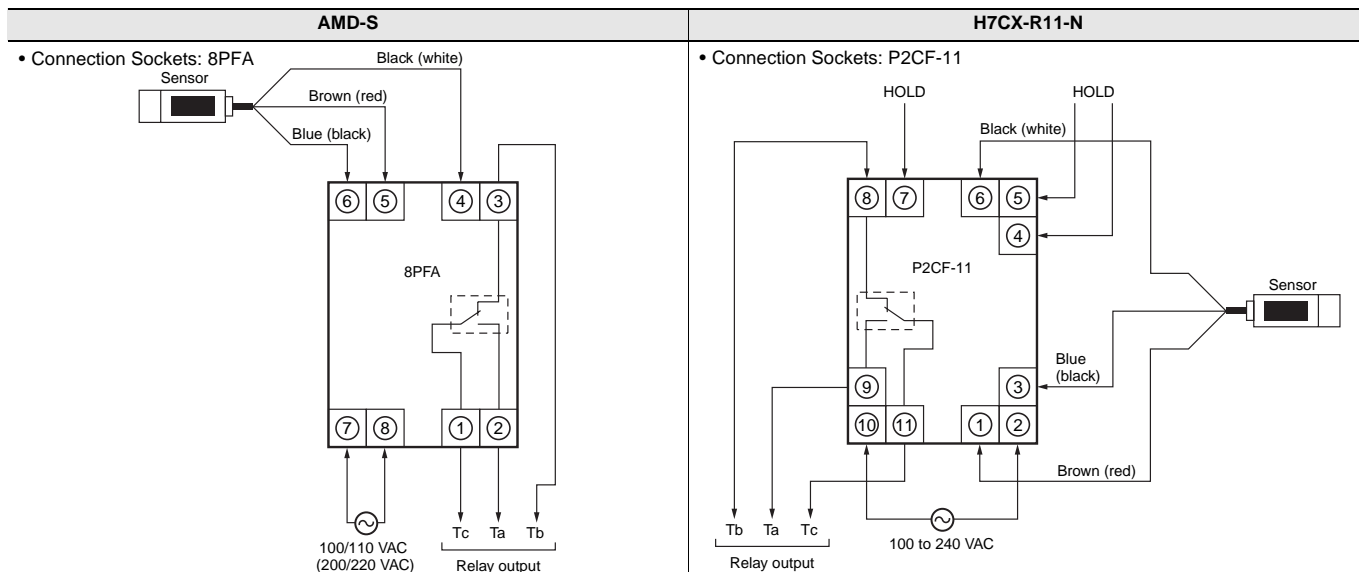

- Note:**
1. Wiring must be changed from an 8-pin socket to an 11-pin socket.
 2. Take into consideration the length of the wires and the terminal numbers.
 3. Order the P2CF-11 Connecting Socket separately.

Setting Procedure

Perform the following settings to achieve the functions of the AMD-S using the H7CX-R11-N.

DIP Switch Settings

Model	AMD-S	H7CX-R11-N	Set value												
Item	AMD-S	DIP switch pin status *													
Measuring ranges	0.01 to 0.1 s (AMD-S□1), 0.1 to 1 s (AMD-S□2), 1 to 10 s (AMD-S□3)	<p>Set DIP switch pin 1 to ON for AMD-compatible mode.</p> <table border="1" style="font-size: small;"> <tr> <th>Pin 1</th> <th>Pin 2</th> <th>Input mode</th> <th>Counting Speed / Minimum input signal width</th> </tr> <tr> <td>ON</td> <td>OFF</td> <td>AMD compatible</td> <td>10 ms</td> </tr> <tr> <td>ON</td> <td>ON</td> <td>AMD compatible</td> <td>1 ms</td> </tr> </table>	Pin 1	Pin 2	Input mode	Counting Speed / Minimum input signal width	ON	OFF	AMD compatible	10 ms	ON	ON	AMD compatible	1 ms	1 ms 10 ms
Pin 1	Pin 2	Input mode	Counting Speed / Minimum input signal width												
ON	OFF	AMD compatible	10 ms												
ON	ON	AMD compatible	1 ms												
Output mode	Rotation increase detection (AMD-SU□) Rotation decrease detection (AMD-SL□)		Lower limit Upper limit												
Average processing	None		OFF												
Input mode	Voltage Input		PNP												

Note: The characters displayed in reverse video are the default settings.

* Refer to page 43 for information on DIP switch settings.

Operation Key Settings

Model	AMD-S	H7CX-R11-N		
		Parameter s	Setting range	Set value
Startup time	Fixed (0.1 to 10 s)	<i>Stmr</i> (STMR)	0.0 ~ 99.9 (0.0 s) (99.9 s)	0.0

Note: The characters displayed in reverse video are the default settings.

Characteristics

Model	AMD-S	H7CX-R11-N
Item		
Supply voltage	-100 to 110 VAC -200 to 220 VAC	-100 to 240 VAC
Input method	Voltage input (high: 4 to 14 V, low: 0 to 1 V)	No-voltage input/voltage input (high: 4.5 to 30 V, low: 0 to 2 V)
External power supply	12 VDC ±1 V, 12 mA	12 VDC (±10%), 100 mA
Relay output	5 A at 200 VAC (resistive load)	3 A at 250 VAC/30 VDC (resistive load)
Output mode	Rotation increase (AMD-SU□) Rotation decrease (AMD-SL□)	HI-LO, AREA, HI-HI, LO-LO (Set using DIP switch.)
Setting method	Input pulse interval (s)	Input pulse interval (s) *
Detection rotation rate range	6 to 6,000 rpm (for 1 pulse/rotation)	0.00006 to 20,000 rpm * (for 1 pulse/rotation)
Startup time	Always from 0.1 to 10 s (Always 10 s if not specified.)	Setting range: 0.0 to 99.9 s
Life expectancy	Output relay electrical operations of 500,000 min.	Output relay electrical operations of 100,000 min.
Memory back-up	None	EEPROM (overwrites: 100,000 times min.)

* When set to AMD mode.

Safety Precautions for All H7CX Series (Common)

⚠ CAUTION

Do not allow pieces of metal, wire clippings, or fine metallic shavings or fillings from installation to enter the product. Doing so may occasionally result in electric shock, fire, or malfunction.



Minor injury due to explosion may occasionally occur. Do not use the Counter where subject to flammable or explosive gas.



Fire may occasionally occur. Tighten the terminal screws to the rated torque.
H7CX terminals: 6.55 to 7.97 lb-in (0.74 to 0.90 N-m)
P2CF Socket terminals: 4.4 lb-in (0.5 N-m)



Minor injury due to electric shock may occasionally occur. Do not touch any of the terminals while power is being supplied. Be sure to mount the terminal cover after wiring.



The life expectancy of the output relay varies considerably according to its usage. Use the output relay within its rated load and electrical life expectancy. If the output relay is used beyond its life expectancy, its contacts may become fused or there may be a risk of fire. Also, be sure that the load current does not exceed the rated load current and when using a heater, be sure to use a thermal switch in the load circuit.



Minor electric shock, fire, or malfunction may occasionally occur. Do not disassemble, modify, or repair the Counter or touch internal components.



Precautions for Safe Use

- The panel surface of the H7CX-A/-R is water-resistant (conforming to NEMA4, IP66, UL Type 4X (Indoor Use Only). To protect the internal circuits from water penetration through the space between the H7CX and operating panel, waterproof packing is included. Attach the Y92F-30 Adapter with sufficient pressure with the reinforcing screws so that water does not penetrate the panel.



- When mounting the Counter to a panel, tighten the two mounting screws alternately, a little at a time, so as to keep them at an equal tightness. If the panel screws are tightened unequally, water may enter the panel.
- Store the Counter at the specified temperature. If the Counter has been stored at a temperature of less than -10°C , allow the Counter to stand at room temperature for at least 3 hours before use.
- Mounting the Counter side-by-side may reduce the life expectancies of internal components.
- Use the Counter within the specified ranges for the ambient operating temperature and humidity.
- Do not use in the following locations:
 - Locations subject to sudden or extreme changes in temperature.
 - Locations where high humidity may result in condensation.
- Do not use the Counter outside of the rated ranges for vibration, shock, water exposure, and oil exposure.
- Do not use this Counter in dusty environments, in locations where corrosive gasses are present, or in locations subject to direct sunlight.
- Install the Counter well away from any sources of static electricity, such as pipes transporting molding materials, powders, or liquids.

- Internal elements may be destroyed if a voltage outside the rated voltage range is applied.
- Be sure that polarity is correct when wiring the terminals.
- Separate the Counter from sources of noise, such as devices with input signals from power lines carrying noise, and wiring for I/O signals.
- Do not connect more than two crimp terminals to the same terminal.
- Up to two wires of the same size and type can be inserted into a single terminals.
- Use the specified wires for wiring. Applicable Wires: AWG 18 to AWG 22, solid or twisted, copper
- Install a switch or circuit breaker that allows the operator to immediately turn OFF the power, and label it to clearly indicate its function.
- When the Counter is operated with no-voltage input (NPN input), approximately 14 V is output from the input terminals. Use a sensor that contains a diode.

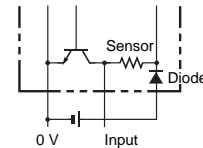

- Use a switch, relay, or other contact so that the rated power supply voltage will be reached within 0.1 seconds. If the power supply voltage is not reached quickly enough, the Counter may malfunction or outputs may be unstable.
- Use a switch, relay, or other contact to turn the power supply OFF instantaneously. Outputs may malfunction and memory errors may occur if the power supply voltage is decreased gradually.
- When changing the set value during operation, because the H7CX uses a constant read-in system, output will turn ON if the set value is equal to the present value.
- When changing the comparison value during operation, because the H7CX uses a constant read-in system, the output status will change if the comparison value is changed to a value on the other side of the present value. (when using as a tachometer)
- If the set value and present value are both 0, the output will turn ON for the default setting. The output will turn OFF during a reset operation. (when using as a counter)
- When the power is turned ON using the factory settings, the output will turn ON after 999.9 s if no pulses are received as count input.
- Do not use organic solvents (such as paint thinners or benzene), strong alkali, or strong acids. They will damage the external finish.
- Confirm that indications are working normally, including the backlight LED, and LCD. The indicator LEDs, LCD, and resin parts may deteriorate more quickly depending on the application environment, preventing normal indications. Periodic inspection and replacement are required.
- The waterproof packing may deteriorate, shrink, or harden depending on the application environment. Periodic inspection and replacement are required.

Precautions for Correct Use

- H7CX models with a 12 to 24-VDC power supply use a transformer-free power supply method in which the power supply terminals are not isolated from the signal input terminals. If a non-isolating DC power supply is used, unwanted current paths may occasionally burn or destroy internal components depending on the wiring. Always check the wiring sufficiently before use.
- An inrush current of approx. 10 A will flow for a short time when the power supply is turned ON. If the capacity of the power supply is not sufficient, the Counter may not start. Be sure to use a power supply with sufficient capacity.
- Maintain voltage fluctuations in the power supply within the specified operating voltage range.
- When turning the power ON and OFF, input signal reception is possible, unstable, or impossible as shown in the diagram below.



- Inrush current generated by turning ON or OFF the power supply may deteriorate contacts on the power supply circuit. Turn ON or OFF to a device with the rated current of more than 10 A.
- The capacity of the external power supply is 100 mA at 12 V. When using a 24 VAC/12 to 24 VDC power supply, reduce the load with the power supply voltage, as shown in the following diagram (DC power supplies only).



- If the prescale value setting is incorrect, a counting error will occur. Check that the settings are correct before using this function.
- Make sure that all settings are appropriate for the application. Unexpected operation resulting in property damage or accidents may occur if the settings are not appropriate.
- Do not leave the Counter for long periods at a high temperature with output current in the ON state. Doing so may result in the premature deterioration of internal components (e.g., electrolytic capacitors).
- EEPROM is used as backup memory when the power is interrupted. The write life of the EEPROM is 100,000 writes. The EEPROM is written at the following times:
 - When the power supply is turned OFF
 - When switching from Configuration Selection Mode or Function Setting Mode to Run Mode
- Dispose of the product according to local ordinances as they apply.

- Attach the front panel when using the Counter. The tabs in the middle of each of four sides secure the front panel to the main body. To remove the panel, widen the four tabs and pull the panel toward you. To mount the panel, fit all four tabs correctly into the grooves on the main body.



Conformance to EN/IEC Standards

- When conforming to EMC standards, refer to the information provided in this datasheet for cable selection and other conditions.
- This is a class A product. In residential areas it may cause radio interference, in which case the user may be required to take adequate measures to reduce interference.
- H7CX-A□-N: Basic insulation is provided between power supply and input terminals, between power supply and output terminals, and between input and output terminals. (However, no insulation is provided between the power supply and input terminals for the H7CX-A□D-N.)
- H7CX-R□-N: Basic insulation is provided between power supply and input terminals and between input and output terminals.
- When double insulation or reinforced insulation is required, apply double insulation or reinforced insulation as defined in IEC 60664 that is suitable for the maximum operating voltage with clearances or solid insulation.
- Connect the input and output terminals to devices that do not have any exposed charged parts.

Warranty and Application Considerations

Read and Understand This Catalog

Please read and understand this catalog before purchasing the products. Please consult your OMRON representative if you have any questions or comments.

Warranty and Limitations of Liability

WARRANTY

OMRON's exclusive warranty is that the products are free from defects in materials and workmanship for a period of one year (or other period if specified) from date of sale by OMRON.

OMRON MAKES NO WARRANTY OR REPRESENTATION, EXPRESS OR IMPLIED, REGARDING NON-INFRINGEMENT, MERCHANTABILITY, OR FITNESS FOR PARTICULAR PURPOSE OF THE PRODUCTS. ANY BUYER OR USER ACKNOWLEDGES THAT THE BUYER OR USER ALONE HAS DETERMINED THAT THE PRODUCTS WILL SUITABLY MEET THE REQUIREMENTS OF THEIR INTENDED USE. OMRON DISCLAIMS ALL OTHER WARRANTIES, EXPRESS OR IMPLIED.

LIMITATIONS OF LIABILITY

OMRON SHALL NOT BE RESPONSIBLE FOR SPECIAL, INDIRECT, OR CONSEQUENTIAL DAMAGES, LOSS OF PROFITS, OR COMMERCIAL LOSS IN ANY WAY CONNECTED WITH THE PRODUCTS, WHETHER SUCH CLAIM IS BASED ON CONTRACT, WARRANTY, NEGLIGENCE, OR STRICT LIABILITY.

In no event shall the responsibility of OMRON for any act exceed the individual price of the product on which liability is asserted.

IN NO EVENT SHALL OMRON BE RESPONSIBLE FOR WARRANTY, REPAIR, OR OTHER CLAIMS REGARDING THE PRODUCTS UNLESS OMRON'S ANALYSIS CONFIRMS THAT THE PRODUCTS WERE PROPERLY HANDLED, STORED, INSTALLED, AND MAINTAINED AND NOT SUBJECT TO CONTAMINATION, ABUSE, MISUSE, OR INAPPROPRIATE MODIFICATION OR REPAIR.

Application Considerations

SUITABILITY FOR USE

OMRON shall not be responsible for conformity with any standards, codes, or regulations that apply to the combination of products in the customer's application or use of the products.

Take all necessary steps to determine the suitability of the product for the systems, machines, and equipment with which it will be used.

Know and observe all prohibitions of use applicable to this product.

NEVER USE THE PRODUCTS FOR AN APPLICATION INVOLVING SERIOUS RISK TO LIFE OR PROPERTY WITHOUT ENSURING THAT THE SYSTEM AS A WHOLE HAS BEEN DESIGNED TO ADDRESS THE RISKS, AND THAT THE OMRON PRODUCTS ARE PROPERLY RATED AND INSTALLED FOR THE INTENDED USE WITHIN THE OVERALL EQUIPMENT OR SYSTEM.

Disclaimers

PERFORMANCE DATA

Performance data given in this catalog is provided as a guide for the user in determining suitability and does not constitute a warranty. It may represent the result of OMRON's test conditions, and the users must correlate it to actual application requirements. Actual performance is subject to the OMRON *Warranty and Limitations of Liability*.

CHANGE IN SPECIFICATIONS

Product specifications and accessories may be changed at any time based on improvements and other reasons. Consult with your OMRON representative at any time to confirm actual specifications of purchased product.

DIMENSIONS AND WEIGHTS

Dimensions and weights are nominal and are not to be used for manufacturing purposes, even when tolerances are shown.

ALL DIMENSIONS SHOWN ARE IN MILLIMETERS.

To convert millimeters into inches, multiply by 0.03937. To convert grams into ounces, multiply by 0.03527.

OMRON Corporation Industrial Automation Company

Tokyo, JAPAN

Contact: www.ia.omron.com

Regional Headquarters

OMRON EUROPE B.V.

Wegalaan 67-69-2132 JD Hoofddorp
The Netherlands

Tel: (31)2356-81-300/Fax: (31)2356-81-388

OMRON ELECTRONICS LLC

One Commerce Drive Schaumburg,
IL 60173-5302 U.S.A.

Tel: (1) 847-843-7900/Fax: (1) 847-843-7787

OMRON ASIA PACIFIC PTE. LTD.

No. 438A Alexandra Road # 05-05/08 (Lobby 2),
Alexandra Technopark,
Singapore 119967

Tel: (65) 6835-3011/Fax: (65) 6835-2711

OMRON (CHINA) CO., LTD.

Room 2211, Bank of China Tower,
200 Yin Cheng Zhong Road,
PuDong New Area, Shanghai, 200120, China

Tel: (86) 21-5037-2222/Fax: (86) 21-5037-2200

Authorized Distributor:

© OMRON Corporation 2009 All Rights Reserved.
In the interest of product improvement,
specifications are subject to change without notice.

CSM_12_1_0115

Cat. No. M079-E1-01

Printed in Japan

0709

Mouser Electronics

Authorized Distributor

Click to View Pricing, Inventory, Delivery & Lifecycle Information:

Omron:

[H7CX-AD-G](#) [H7CX-AU AC100-240](#) [H7CX-A4W-AC100-240](#) [H7CX-AS-N-AC100-240](#) [H7CX-A4-AC100-240](#) [H7CX-A114-N-AC100-240](#) [H7CX-A-AC100-240](#) [H7CX-A114-AC100-240](#) [H7CX-AW-N-AC100-240](#) [H7CX-A4D-N-DC12-24](#) [H7CX-AW-AC100-240](#) [H7CX-A11D1-DC12-24/AC24](#) [H7CX-A114D1-N-DC12-24/AC24](#) [H7CX-A114D1-DC12-24/AC24](#) [H7CX-AWD1-DC12-24/AC24](#) [H7CX-A11-AC100-240](#) [H7CX-AWSD-N-DC12-24](#) [H7CX-A4WSD-N DC12-24](#) [H7CX-ASD-N-DC12-24](#) [H7CX-AUD1-N DC12-24/AC24](#) [H7CX-A11D1-N DC12-24/AC24](#) [H7CX-A4SD-N DC12-24](#) [H7CX-R11WD1-N DC12-24/AC24](#) [H7CX-AWSD1-N DC12-24/AC24](#) [H7CX-R11W-N AC100-240](#) [H7CX-A11SD1-N DC12-24/AC24](#) [H7CX-R11D1-N DC12-24/AC24](#) [H7CX-R11-N AC100-240](#) [H7CX-A4-N-AC100-240](#) [H7CX-A11S-N AC100-240](#) [H7CX-AWS-N AC100-240](#) [H7CX-AU-N AC100-240](#) [H7CX-AWD1-N-DC12-24/AC24](#) [H7CX-A11-N AC100/240](#) [H7CX-A4W-N-AC100-240](#) [H7CX-AUSD1-N DC12-24/AC24](#) [H7CX-A114S-N AC100-240](#) [H7CX-A4S-N AC100-240](#)

Компания «Life Electronics» занимается поставками электронных компонентов импортного и отечественного производства от производителей и со складов крупных дистрибьюторов Европы, Америки и Азии.

С конца 2013 года компания активно расширяет линейку поставок компонентов по направлению коаксиальный кабель, кварцевые генераторы и конденсаторы (керамические, пленочные, электролитические), за счёт заключения дистрибьюторских договоров

Мы предлагаем:

- Конкуренеспособные цены и скидки постоянным клиентам.
- Специальные условия для постоянных клиентов.
- Подбор аналогов.
- Поставку компонентов в любых объемах, удовлетворяющих вашим потребностям.
- Приемлемые сроки поставки, возможна ускоренная поставка.
- Доставку товара в любую точку России и стран СНГ.
- Комплексную поставку.
- Работу по проектам и поставку образцов.
- Формирование склада под заказчика.
- Сертификаты соответствия на поставляемую продукцию (по желанию клиента).
- Тестирование поставляемой продукции.
- Поставку компонентов, требующих военную и космическую приемку.
- Входной контроль качества.
- Наличие сертификата ISO.

В составе нашей компании организован Конструкторский отдел, призванный помогать разработчикам, и инженерам.

Конструкторский отдел помогает осуществить:

- Регистрацию проекта у производителя компонентов.
- Техническую поддержку проекта.
- Защиту от снятия компонента с производства.
- Оценку стоимости проекта по компонентам.
- Изготовление тестовой платы монтаж и пусконаладочные работы.



Тел: +7 (812) 336 43 04 (многоканальный)

Email: org@lifeelectronics.ru