

CAT3604

4-Channel Regulated Charge Pump White LED Driver

Description

The CAT3604 is a charge pump operating in either 1x (LDO) mode or 1.5x fractional mode regulating current through each of the 4 LED pins. Operation at a fixed high frequency of 1 MHz typical allows the use of very small value ceramic capacitors.

The CAT3604 drives white light-emitting diodes (LEDs) connected in parallel and provides tightly matched regulated current to achieve uniformity of brightness in LCD backlighting applications. An external resistor R_{SET} controls the output current level. LED currents of up to 30 mA are supported over a range of input supply voltages from 3 V to 5.5 V, making the device ideal for battery-powered applications.

LED dimming can be accomplished by several methods including using a DC voltage to set the RSET pin current, applying a PWM signal on the Control signals, or adding a switched resistor in parallel with RSET. The Enable input pin allows the device to be placed in power-down mode with “zero” quiescent current.

The CAT3604 features short circuit and overcurrent limiting protection. The device is available in a 16-pad TQFN package with a max height of 0.8 mm.

Features

- Drives Individually up to 4 LEDs
- Output Current up to 30 mA per LED
- Digital Control On/Off of Each LED
- Compatible with Supply Voltage of 3 V to 5.5 V
- Power Efficiency up to 93%
- 2 Modes of Operation 1x and 1.5x
- Automatic Short Circuit Detect/Disable
- High-frequency Operation at 1 MHz
- Low Value Ceramic Capacitors
- “604” Compatible Pinout
- Soft Start and Current Limiting
- TQFN 16-pad Package, 4 x 4 mm, 0.8 mm Max Height
- These Devices are Pb-Free, Halogen Free/BFR Free and are RoHS Compliant

Applications

- Color LCD and Keypad Backlighting
- Cellular Phones
- Handheld Devices
- Digital Cameras
- PDAs
- Portable MP3 Players



ON Semiconductor®

<http://onsemi.com>



TQFN-16
HV4 SUFFIX
CASE 510AE

PIN CONNECTIONS (Note 1)

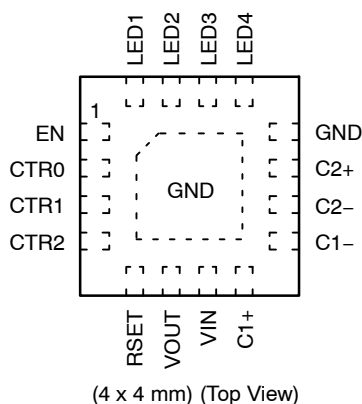

MARKING DIAGRAMS



G364 = CAT3604HV4-T2
CDBA = CAT3604HV4-GT2

ORDERING INFORMATION

Device	Package	Shipping
CAT3604HV4-T2	TQFN-16 (Note 2)	2,000/ Tape & Reel
CAT3604HV4-GT2	TQFN-16 (Note 3)	

1. The package exposed pad is electrically connected inside the package to GND and to pin 12.
2. Matte-Tin Plated Finish (RoHS-compliant).
3. NiPdAu Plated Finish (RoHS-compliant).

CAT3604

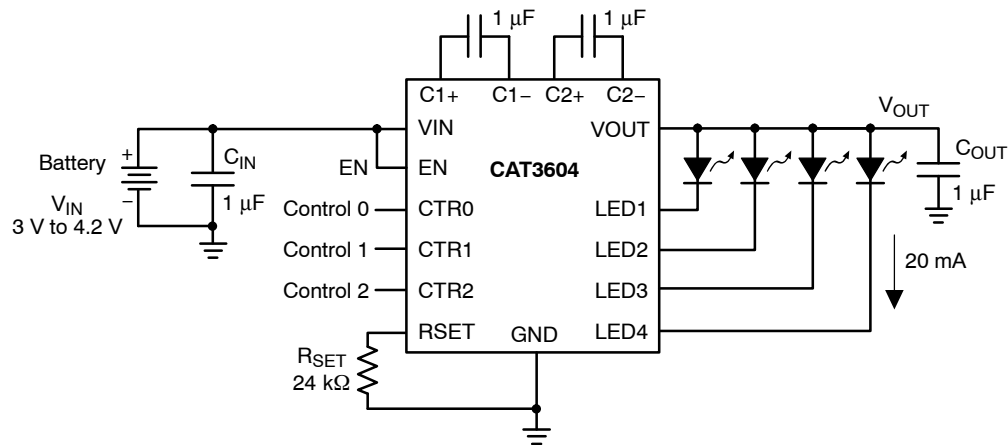

Figure 1. Typical Application Circuit

Table 1. PIN DESCRIPTION

Pin #	Name	Function
1	EN	Enable input, active HIGH
2	CTR0	Digital control input 0
3	CTR1	Digital control input 1
4	CTR2	Digital control input 2
5	RSET	The LED output current is set by the current sourced out of the RSET pin
6	VOUT	Charge pump output connected to the LED anodes
7	VIN	Supply voltage
8	C1+	Bucket capacitor 1 terminal
9	C1-	Bucket capacitor 1 terminal
10	C2-	Bucket capacitor 2 terminal
11	C2+	Bucket capacitor 2 terminal
12	GND	Ground reference
13	LED4	LED 4 cathode terminal
14	LED3	LED 3 cathode terminal
15	LED2	LED 2 cathode terminal
16	LED1	LED 1 cathode terminal
Pad	GND Pad	Ground reference

CAT3604

Table 2. ABSOLUTE MAXIMUM RATINGS

Parameter	Rating	Unit
VIN, VOUT, LEDx voltage	-0.3 to 7.0	V
EN, CTRx voltage	-0.3 to VIN	V
RSET voltage	-0.3 to VIN	V
RSET current	±1	mA
Ambient Temperature Range	-40 to +85	°C
Storage Temperature Range	-65 to +160	°C
Lead Temperature	300	°C
ESD Rating HBM (Human Body Model)	2,000	V
ESD Rating MM (Machine Model) (Note 4)	200	V

Stresses exceeding Maximum Ratings may damage the device. Maximum Ratings are stress ratings only. Functional operation above the Recommended Operating Conditions is not implied. Extended exposure to stresses above the Recommended Operating Conditions may affect device reliability.

4. Machine model is with 200 pF capacitor discharged directly into each pin.

Table 3. RECOMMENDED OPERATING CONDITIONS

Parameter	Range	Unit
VIN	3.0 to 5.5	V
Ambient Temperature Range	-40 to +85	°C
Input/Output/Bucket Capacitors	1 ±20% typical	µF
I _{LED} per LED pin	0 to 30	mA

5. Typical application circuit with external components is shown on page 2.

Table 4. ELECTRICAL OPERATING CHARACTERISTICS

(Limits over recommended operating conditions unless specified otherwise. Typical values at T_A = 25°C, V_{IN} = 3.5 V, I_{RSET} = 5 µA)

Symbol	Parameter	Conditions	Min	Typ	Max	Units
I _Q	Quiescent Current	V _{EN} = 0 V, Shutdown Mode		0.05	1	µA
		1x Mode, No Load		0.3	1	mA
		1.5x Mode, No Load		2.6	5	mA
V _{RSET}	RSET Regulated Voltage		1.17	1.2	1.23	V
I _{LED}	Programmed LED Current	I _{RSET} = 5 µA		2.4		mA
		I _{RSET} = 37 µA		15.0		
		I _{RSET} = 78 µA		30.0		
I _{LED-ACC}	LED Current Accuracy	0.5 mA ≤ I _{LED} ≤ 3 mA		±15		%
		3 mA ≤ I _{LED} ≤ 30 mA		±5		
I _{LED-DEV}	LED Channel Matching	(I _{LED} - I _{LEDAVG}) / I _{LEDAVG}		±3		%
R _{OUT}	Output Resistance (Open Loop)	1x Mode		1.4	2.5	Ω
		1.5x Mode, I _{OUT} = 100 mA		6.5	10	
f _{OSC}	Charge Pump Frequency		0.8	1.0	1.3	MHz
T _{DROPOUT}	1x to 1.5x Mode Transition Dropout Delay		0.4	0.6	0.9	ms
I _{EN-CTR}	Input Leakage Current	On Inputs EN, CTR0, 1 & 2		0.001	1	µA
V _{EN-CTR}	High Detect Threshold Low	On Inputs EN, CTR0, 1 & 2	0.4	0.8	1.3	V
I _{SC}	Input Current Limit	V _{OUT} = GND	30	45	60	mA
I _{LIM}	Maximum Input Current	V _{OUT} > 1 V	200	400	600	mA

CAT3604

Block Diagram

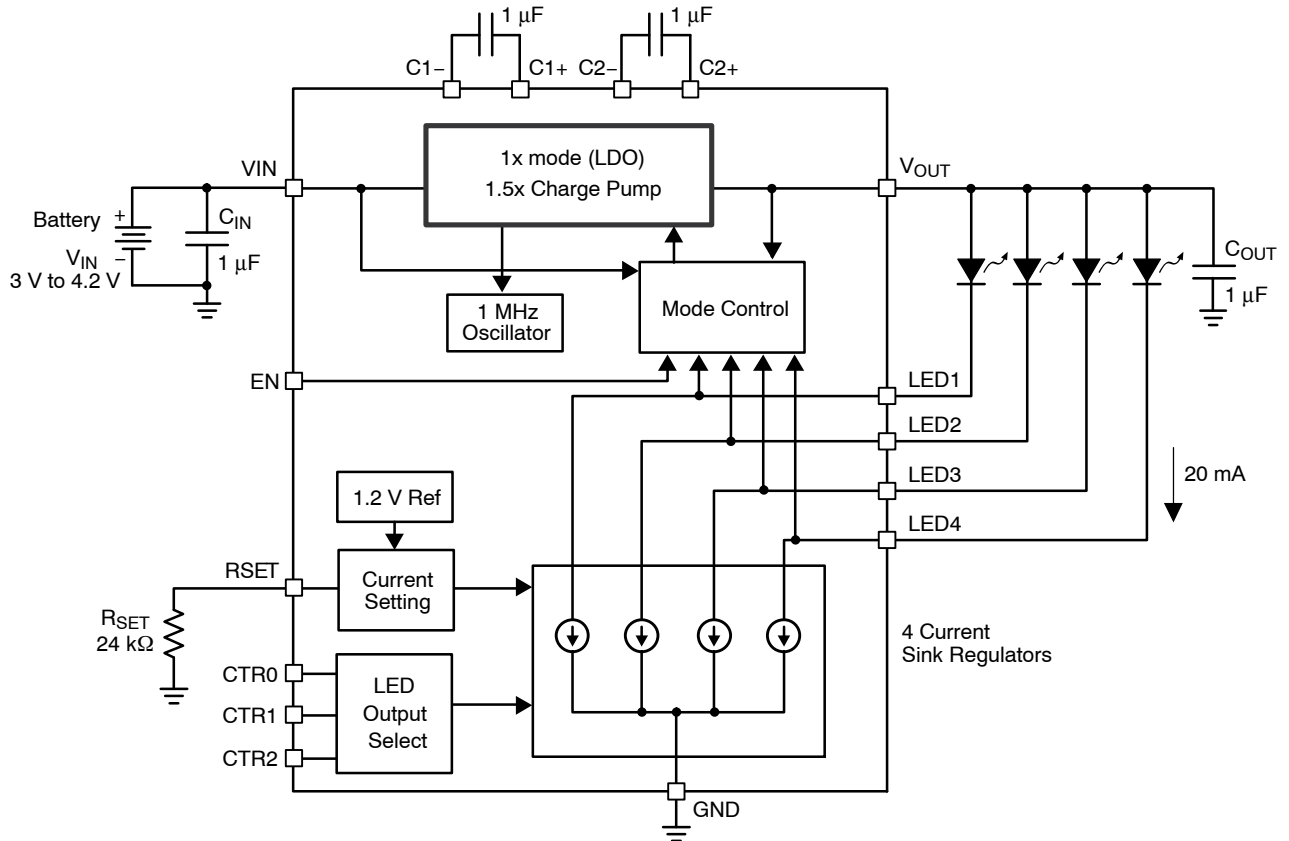

Figure 2. CAT3604 Functional Block Diagram

Basic Operation

At power-up, the CAT3604 starts operation in 1x mode. If it is able to drive the programmed LED current, it continues in 1x mode. If the battery voltage drops to a level where the LED current cannot be met, the driver automatically switches into 1.5x mode. The 1.5x charge pump will boost the output voltage accordingly to achieve the nominal LED current.

The operating mode is reinitialized each and every time the chip is powered up or is taken out of shutdown mode (via EN pin). The use of the control pins (CTR0, CTR1, CTR2) does not reconfigure the mode of operation.

LED Current Setting

The LED current is set by the external resistor R_{SET} connected between the RSET pin and ground. Table 5 lists various LED currents and the associated R_{SET} resistor value for standard 1% precision surface mount resistors.

The digital control lines CTR0, CTR1 and CTR2 allow to turn On or Off a combination of LEDs as shown in Table 6.

Short Circuit Detect/Disables

The unused LED channels can also be turned off by connecting the respective LED pins to VOUT. In which case, the corresponding LED driver is disabled and the typical LED sink current is only about 20 μ A. When the following equation is true on any channel, the driver turns off the LED channel:

$$V_{OUT} - V_{LED} \leq 1 \text{ V (LED channel OFF)}$$

Note: The CAT3604 is designed to drive LEDs with forward voltage greater than 1 V and is not compatible with resistive loads.

Table 5. RSET Resistor Selection

LED Current (mA)	R_{SET} (k Ω)
1	649
2	287
5	102
10	49.9
15	32.4
20	23.7
30	15.4

Table 6. LED Selection

Control Lines			LED Outputs			
CTR2	CTR1	CTR0	LED4	LED3	LED2	LED1
0	0	0	–	–	–	ON
0	0	1	–	–	ON	–
0	1	0	–	ON	–	–
0	1	1	ON	–	–	–
1	0	0	–	–	ON	ON
1	0	1	–	ON	ON	ON
1	1	0	ON	ON	ON	ON
1	1	1	–	–	–	–

NOTE: 1 = logic high (or VIN)
 0 = logic low (or GND)
 – = LED output OFF

TYPICAL CHARACTERISTICS

($V_{IN} = 3.6\text{ V}$, $EN = V_{IN}$, $C_{IN} = C_{OUT} = 1\ \mu\text{F}$, $R_{SET} = 24\ \text{k}\Omega$, $T_{AMB} = 25^\circ\text{C}$, unless otherwise specified.)

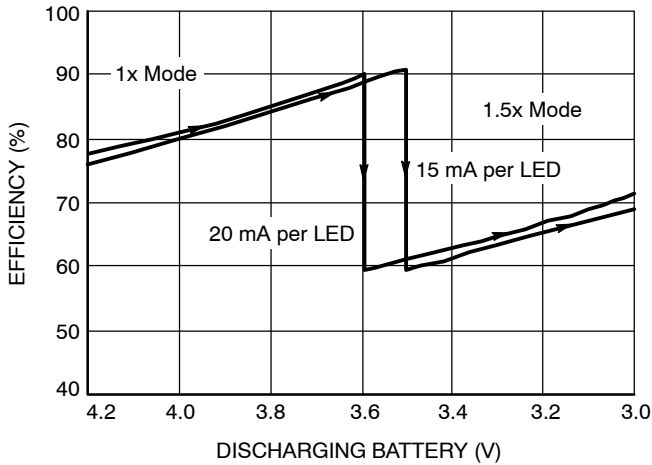

Figure 3. Efficiency vs. Input Voltage (4 LEDs)

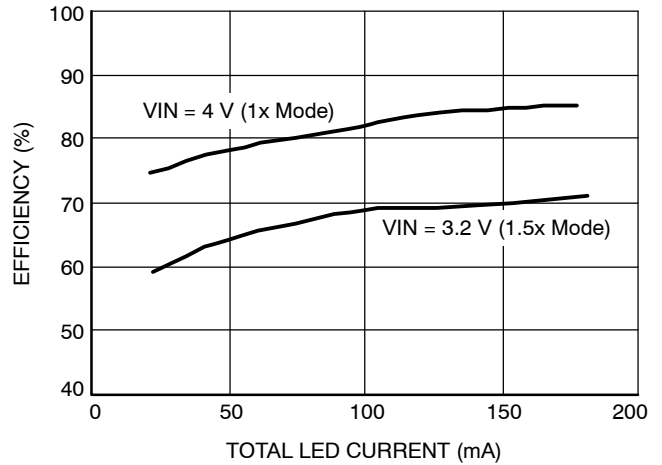

Figure 4. Efficiency vs. Total LED Current (4 LEDs)

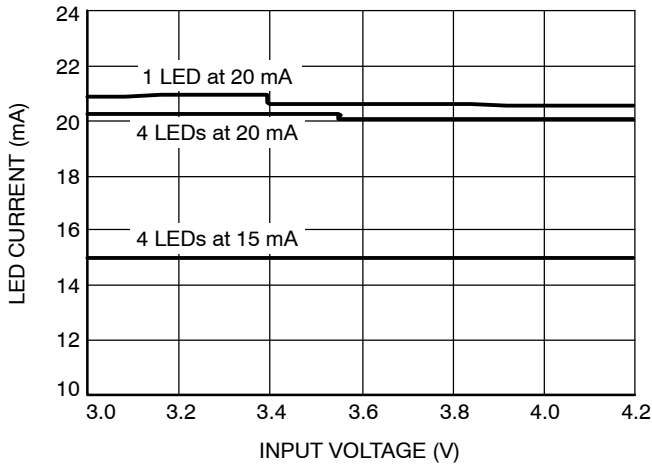

Figure 5. LED Current vs. Input Voltage

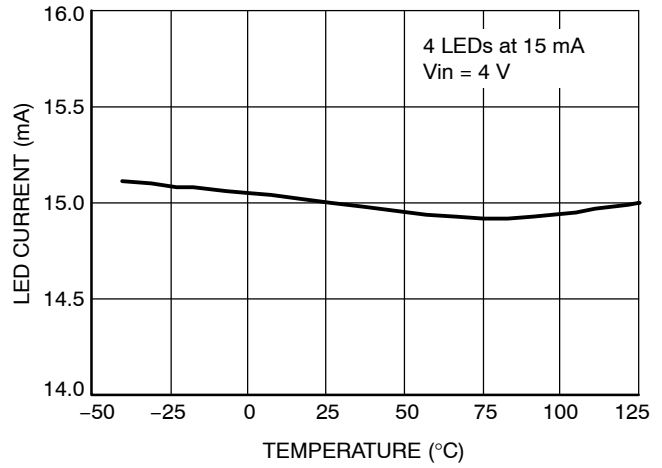

Figure 6. LED Current vs. Temperature

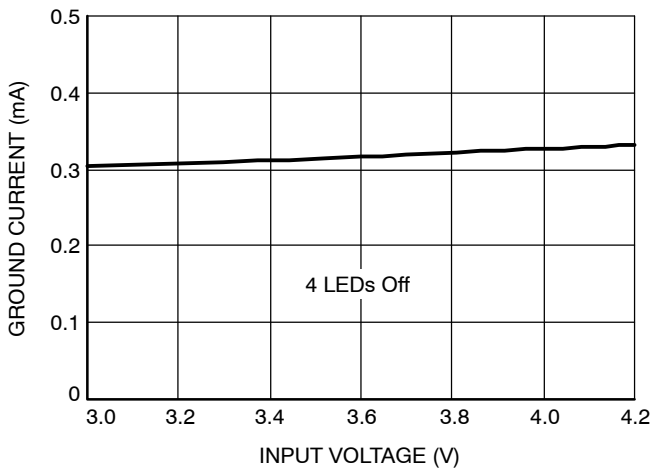

Figure 7. Ground Current vs. Input Voltage (1x Mode)

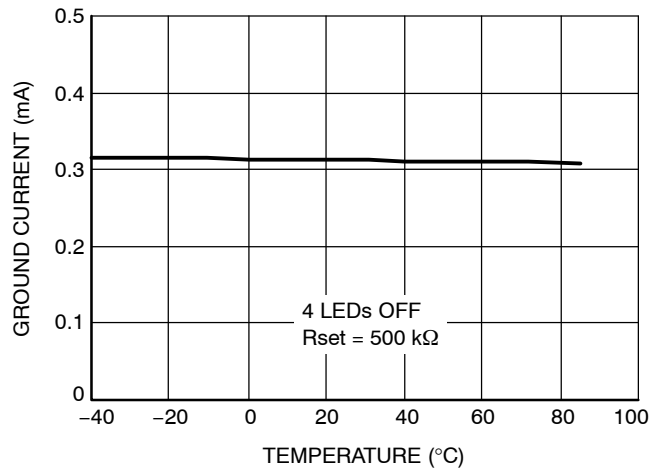

Figure 8. Ground Current vs. Temperature (1x Mode)

CAT3604

TYPICAL CHARACTERISTICS

($V_{IN} = 3.6\text{ V}$, $EN = V_{IN}$, $C_{IN} = C_{OUT} = 1\ \mu\text{F}$, $R_{SET} = 24\ \text{k}\Omega$, $T_{AMB} = 25^\circ\text{C}$, unless otherwise specified.)

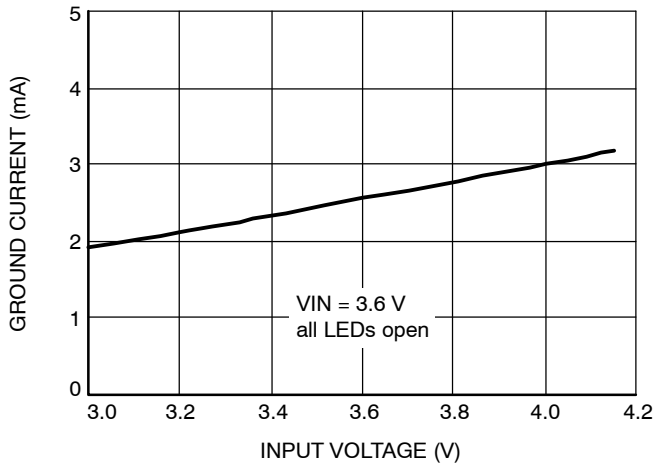

Figure 9. Ground Current vs. Input Voltage (1.5x Mode)

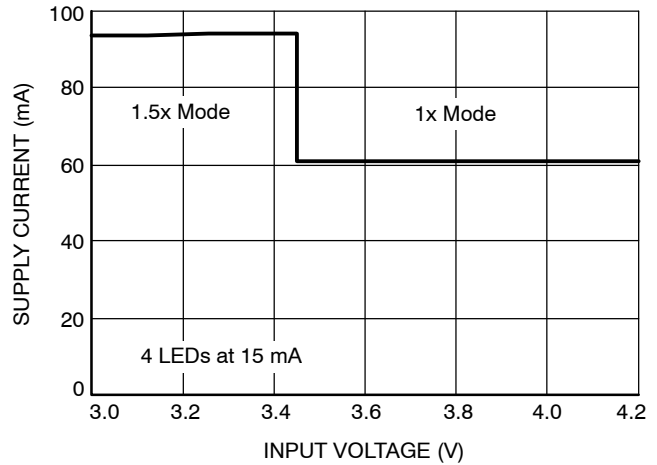

Figure 10. Supply Current vs. Input Voltage

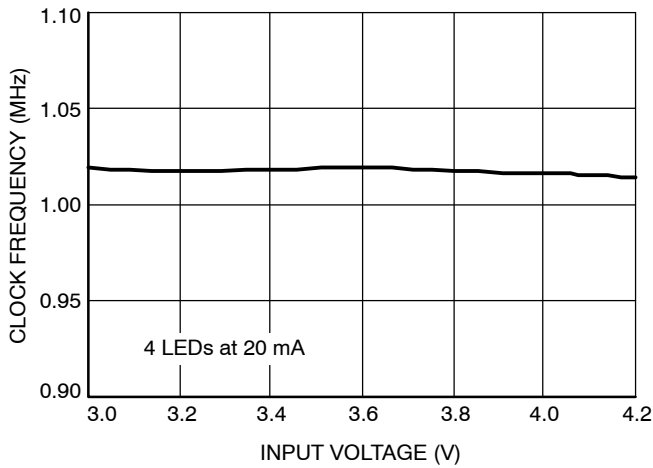

Figure 11. Oscillator Frequency vs. Input Voltage

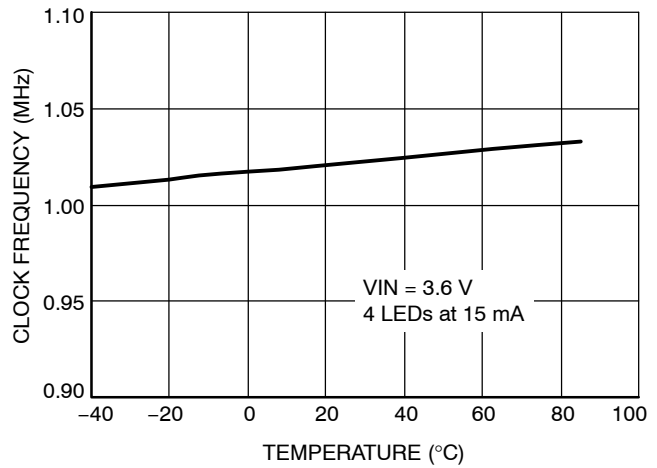

Figure 12. Oscillator Frequency vs. Temperature

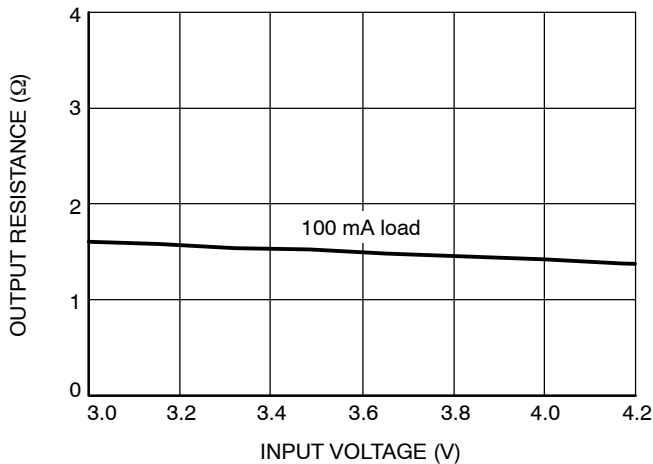

Figure 13. Output Resistance vs. Input Voltage (1x Mode)

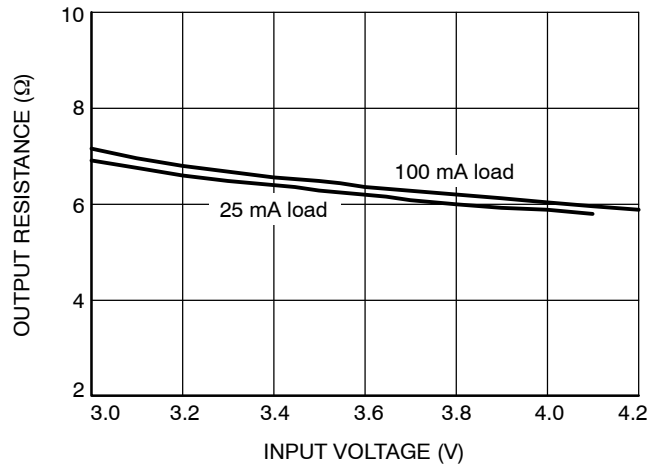

Figure 14. Output Resistance vs. Input Voltage (1.5x Mode)

CAT3604

TYPICAL CHARACTERISTICS

($V_{IN} = 3.6\text{ V}$, $EN = V_{IN}$, $C_{IN} = C_{OUT} = 1\ \mu\text{F}$, $R_{SET} = 24\ \text{k}\Omega$, $T_{AMB} = 25^\circ\text{C}$, unless otherwise specified.)

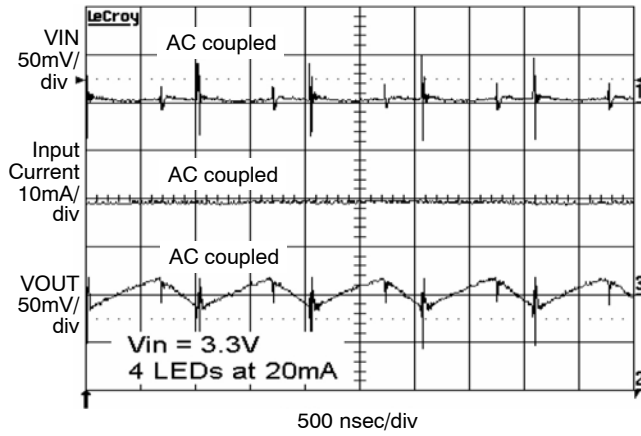

Figure 15. Switching Waveforms in 1.5x Mode

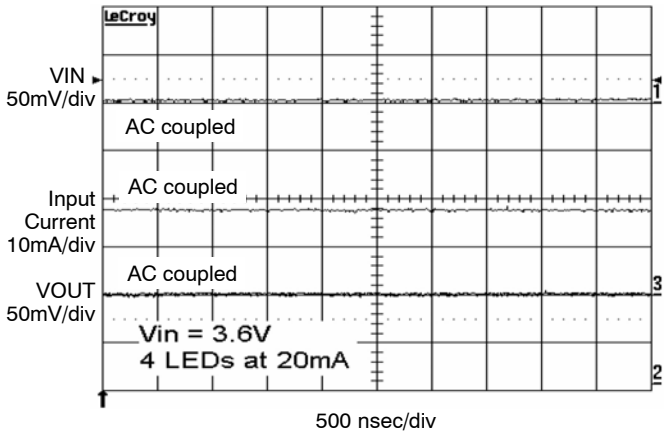

Figure 16. Operating Waveforms in 1x Mode

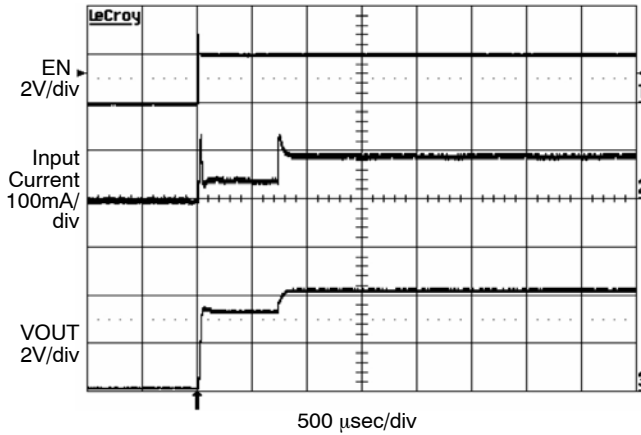

Figure 17. Power Up 4 LEDs at 15 mA, $V_{in} = 3\text{ V}$ (1.5x Mode)

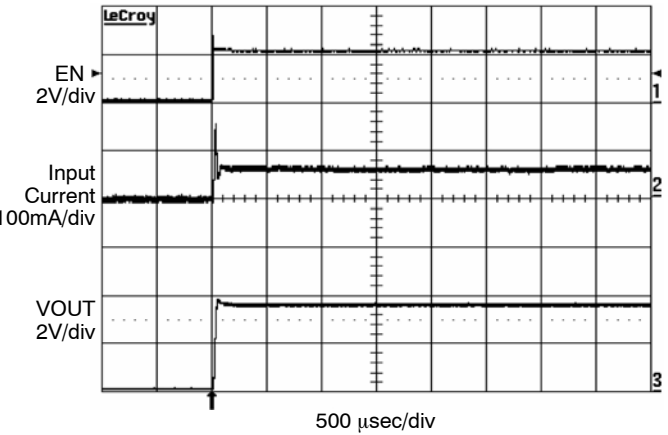

Figure 18. Power Up 4 LEDs at 15 mA, $V_{in} = 3.6\text{ V}$ (1x Mode)

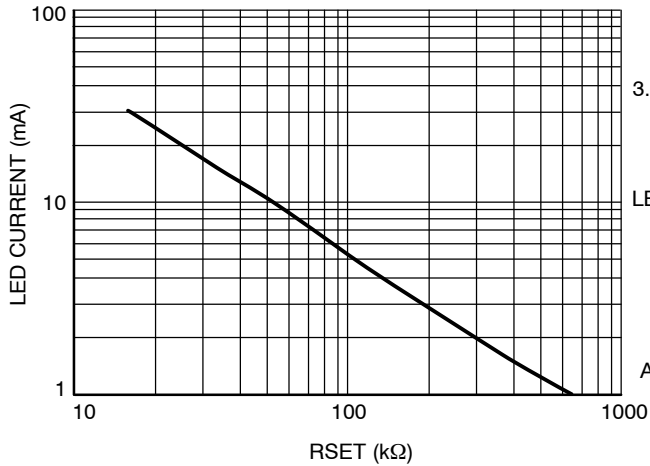

Figure 19. LED Current vs. R_{SET}

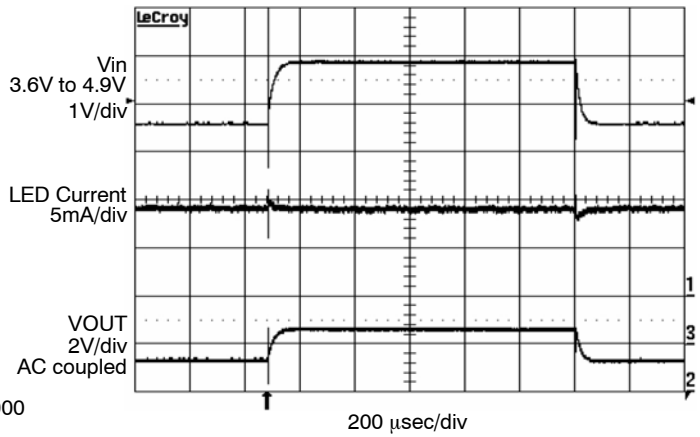

Figure 20. Line Transient Response in 1x Mode

CAT3604

TYPICAL CHARACTERISTICS

($V_{IN} = 3.6\text{ V}$, $EN = V_{IN}$, $C_{IN} = C_{OUT} = 1\ \mu\text{F}$, unless otherwise specified.)

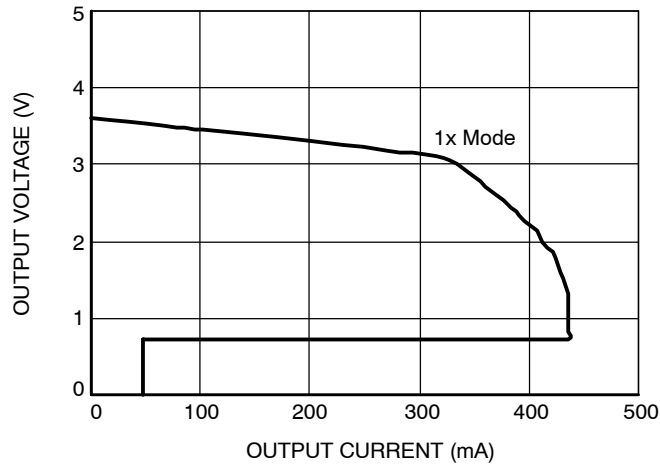

Figure 21. Foldback Current Limiting

Recommended Layout

When the driver is in the 1.5x charge pump mode, the 1 MHz switching frequency operation requires to minimize trace length and impedance to ground on all 4 capacitors. A ground plane should cover the area on the bottom side of the PCB opposite to the IC and the bypass capacitors. Capacitors C_{in} and C_{out} require short connection to ground which can be done with multiple vias as shown on Figure 22.

A square copper area matches the QFN16 exposed pad (GND) which is connected by a trace to the pin 12 pad (GND). A large via (metalized hole) centered in the square pad provides a low impedance connection to the ground plane on the opposite side of the PCB and allows the heat dissipated by the driver IC to spread out resulting in excellent thermal performance.

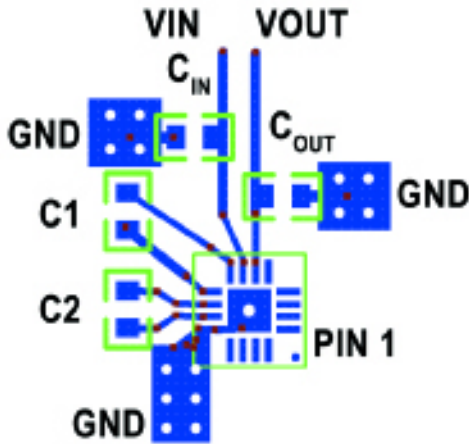

Figure 22. PCB Layout

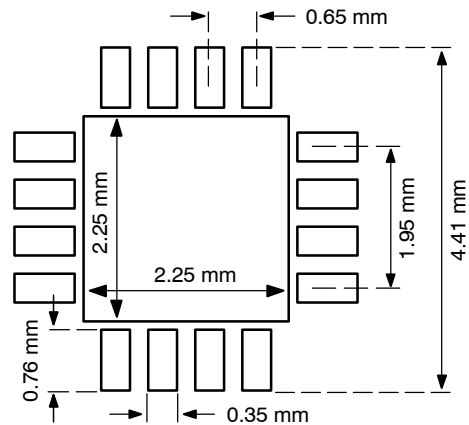
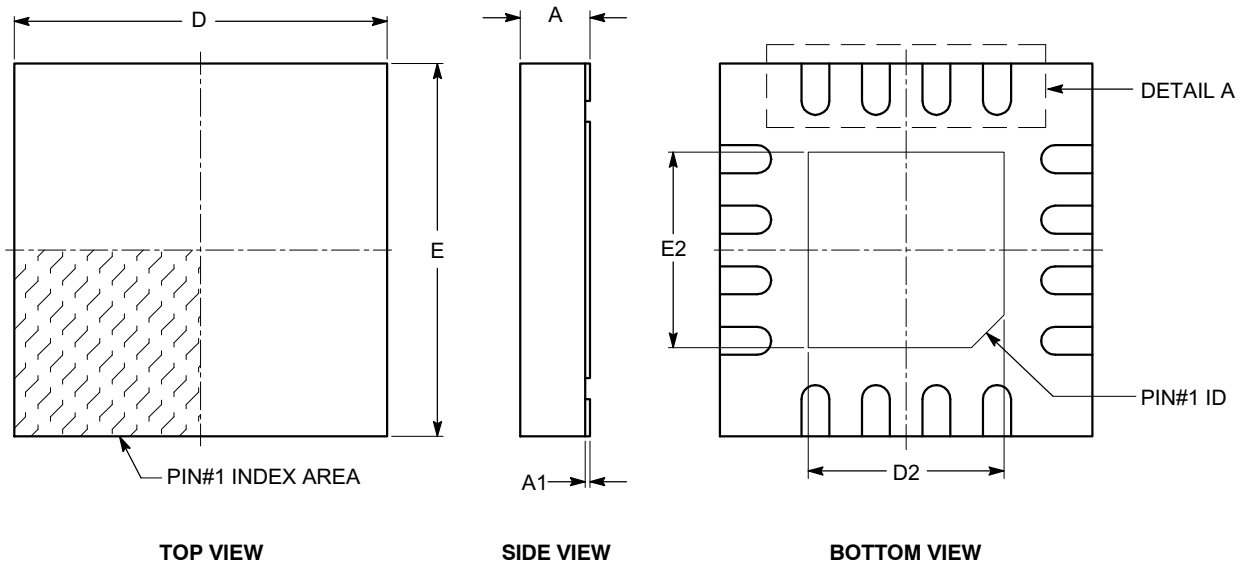

Figure 23. Recommended QFN 16 Package Land Pattern

CAT3604

PACKAGE DIMENSIONS

TQFN16, 4x4
CASE 510AE-01
ISSUE A



SYMBOL	MIN	NOM	MAX
A	0.70	0.75	0.80
A1	0.00	0.02	0.05
A3	0.20 REF		
b	0.25	0.30	0.35
D	3.90	4.00	4.10
D2	2.00	---	2.25
E	3.90	4.00	4.10
E2	2.00	---	2.25
e	0.65 BSC		
L	0.45	---	0.65

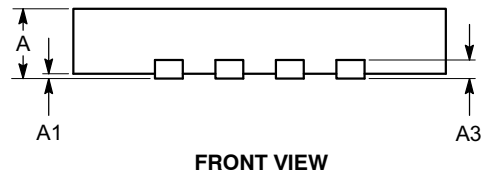
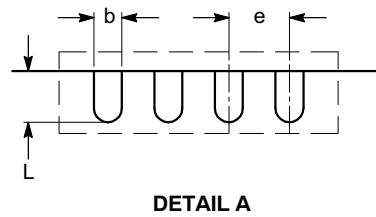

Notes:

- (1) All dimensions are in millimeters.
- (2) Complies with JEDEC MO-220.

CAT3604

Example of Ordering Information (Notes 6, 7)

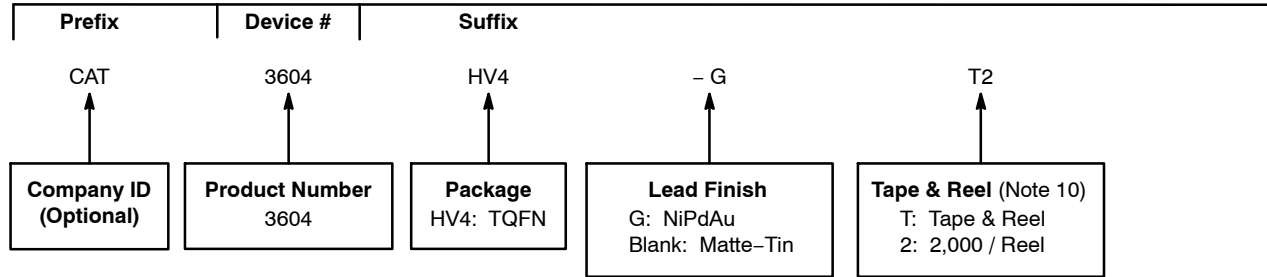

- The device used in the above example is a CAT3604HV4-GT2 (TQFN, NiPdAu Plated Finish, Tape & Reel, 2,000/Reel).
- All packages are RoHS-compliant (Lead-free, Halogen-free).
- The standard lead finish is NiPdAu.
- For additional package and temperature options, please contact your nearest ON Semiconductor Sales office.
- For information on tape and reel specifications, including part orientation and tape sizes, please refer to our Tape and Reel Packaging Specifications Brochure, BRD8011/D.

ON Semiconductor and  are registered trademarks of Semiconductor Components Industries, LLC (SCILLC). SCILLC reserves the right to make changes without further notice to any products herein. SCILLC makes no warranty, representation or guarantee regarding the suitability of its products for any particular purpose, nor does SCILLC assume any liability arising out of the application or use of any product or circuit, and specifically disclaims any and all liability, including without limitation special, consequential or incidental damages. "Typical" parameters which may be provided in SCILLC data sheets and/or specifications can and do vary in different applications and actual performance may vary over time. All operating parameters, including "Typicals" must be validated for each customer application by customer's technical experts. SCILLC does not convey any license under its patent rights nor the rights of others. SCILLC products are not designed, intended, or authorized for use as components in systems intended for surgical implant into the body, or other applications intended to support or sustain life, or for any other application in which the failure of the SCILLC product could create a situation where personal injury or death may occur. Should Buyer purchase or use SCILLC products for any such unintended or unauthorized application, Buyer shall indemnify and hold SCILLC and its officers, employees, subsidiaries, affiliates, and distributors harmless against all claims, costs, damages, and expenses, and reasonable attorney fees arising out of, directly or indirectly, any claim of personal injury or death associated with such unintended or unauthorized use, even if such claim alleges that SCILLC was negligent regarding the design or manufacture of the part. SCILLC is an Equal Opportunity/Affirmative Action Employer. This literature is subject to all applicable copyright laws and is not for resale in any manner.

PUBLICATION ORDERING INFORMATION

LITERATURE FULFILLMENT:

Literature Distribution Center for ON Semiconductor
P.O. Box 5163, Denver, Colorado 80217 USA
Phone: 303-675-2175 or 800-344-3860 Toll Free USA/Canada
Fax: 303-675-2176 or 800-344-3867 Toll Free USA/Canada
Email: orderlit@onsemi.com

N. American Technical Support: 800-282-9855 Toll Free
USA/Canada
Europe, Middle East and Africa Technical Support:
Phone: 421 33 790 2910
Japan Customer Focus Center
Phone: 81-3-5773-3850

ON Semiconductor Website: www.onsemi.com

Order Literature: <http://www.onsemi.com/orderlit>

For additional information, please contact your local Sales Representative

Компания «Life Electronics» занимается поставками электронных компонентов импортного и отечественного производства от производителей и со складов крупных дистрибьюторов Европы, Америки и Азии.

С конца 2013 года компания активно расширяет линейку поставок компонентов по направлению коаксиальный кабель, кварцевые генераторы и конденсаторы (керамические, пленочные, электролитические), за счёт заключения дистрибьюторских договоров

Мы предлагаем:

- Конкуренспособные цены и скидки постоянным клиентам.
- Специальные условия для постоянных клиентов.
- Подбор аналогов.
- Поставку компонентов в любых объемах, удовлетворяющих вашим потребностям.
- Приемлемые сроки поставки, возможна ускоренная поставка.
- Доставку товара в любую точку России и стран СНГ.
- Комплексную поставку.
- Работу по проектам и поставку образцов.
- Формирование склада под заказчика.
- Сертификаты соответствия на поставляемую продукцию (по желанию клиента).
- Тестирование поставляемой продукции.
- Поставку компонентов, требующих военную и космическую приемку.
- Входной контроль качества.
- Наличие сертификата ISO.

В составе нашей компании организован Конструкторский отдел, призванный помогать разработчикам, и инженерам.

Конструкторский отдел помогает осуществить:

- Регистрацию проекта у производителя компонентов.
- Техническую поддержку проекта.
- Защиту от снятия компонента с производства.
- Оценку стоимости проекта по компонентам.
- Изготовление тестовой платы монтаж и пусконаладочные работы.



Тел: +7 (812) 336 43 04 (многоканальный)

Email: org@lifeelectronics.ru