

## 1 Form A Solid-State Relay

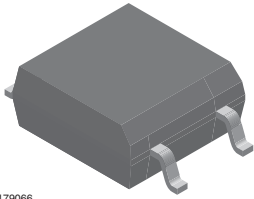

i179066

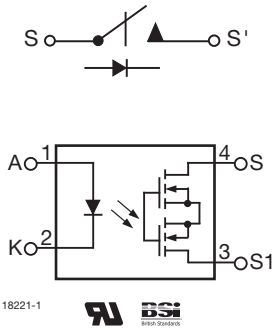

18221-1



### DESCRIPTION

The LH1546AEF (4 pin SOP) is robust, ideal for telecom and ground fault applications. It is an SPST normally open switch (1 form A) that replaces electromechanical relays in many applications. It is constructed using a GaAs LED for actuation control and an integrated monolithic die for the switch output. The die, fabricated in a high-voltage dielectrically isolated BCDMOS technology, is comprised of a photodiode array, switch control circuitry and MOSFET switches. In addition, it employs current-limiting circuitry which meets lightning surge testing as per ANSI/TIA-968-B and other regulatory voltage surge requirements when overvoltage protection is provided.

### FEATURES

- Current limit protection
- Isolation test voltage 3000 V<sub>RMS</sub>
- Typical R<sub>ON</sub> 28 Ω
- Load voltage 350 V
- Load current 120 mA
- High surge capability
- Clean bounce free switching
- Low power consumption
- High reliability monolithic receptor
- SMD lead available on tape and reel
- Equivalent to CPC1035N
- Compliant to RoHS Directive 2002/95/EC and in accordance to WEEE 2002/96/EC



RoHS  
COMPLIANT

### APPLICATIONS

- General telecom switching
  - On/off hook control
  - Ring relay
  - Dial pulse
  - Ground start
  - Ground fault protection
- Instrumentation
- Industrial controls

### Note

- See "solid-state relays" (application note 56)

### AGENCY APPROVALS

UL1577: file no. E52744 system code O

BSI/BABT: certification no. 8500 issue 2

ORDERING INFORMATION										
L	H	1	5	4	6	A	#	#	T	#
PART NUMBER						ELECTR. VARIATION	PACKAGE CONFIG.		TAPE AND REEL	
SOP-#										
PACKAGE					UL, BSI					
SOP-4, tape and reel (product rotated in tape)					LH1546AEFT2					
SOP-4, tape and reel					LH1546AEFTR					
SOP-4, tubes					LH1546AEF					



ABSOLUTE MAXIMUM RATINGS ( $T_{amb} = 25\text{ }^{\circ}\text{C}$ , unless otherwise specified)				
PARAMETER	TEST CONDITION	SYMBOL	VALUE	UNIT
<b>INPUT</b>				
LED continuous forward current		$I_F$	50	mA
LED reverse voltage	$I_R \leq 10\text{ }\mu\text{A}$	$V_R$	6	V
<b>OUTPUT</b>				
DC or peak AC load voltage	$I_L \leq 50\text{ }\mu\text{A}$	$V_L$	350	V
Continuous DC load current at 25 °C, bidirectional		$I_L$	120	mA
<b>SSR</b>				
SSR output power dissipation (continuous)		$P_{diss}$	550	mW
Ambient temperature range		$T_{amb}$	- 40 to + 85	$^{\circ}\text{C}$
Storage temperature range		$T_{stg}$	- 40 to + 150	$^{\circ}\text{C}$
Soldering temperature <sup>(1)</sup>	$t = 10\text{ s max.}$	$T_{sld}$	260	$^{\circ}\text{C}$
Isolation test voltage	$t = 1\text{ s}$	$V_{ISO}$	3000	$V_{RMS}$
Isolation resistance	$V_{IO} = 500\text{ V}, T_{amb} = 25\text{ }^{\circ}\text{C}$	$R_{IO}$	$\geq 10^{12}$	$\Omega$
	$V_{IO} = 500\text{ V}, T_{amb} = 100\text{ }^{\circ}\text{C}$	$R_{IO}$	$\geq 10^{11}$	$\Omega$

**Notes**

- Stresses in excess of the absolute maximum ratings can cause permanent damage to the device. Functional operation of the device is not implied at these or any other conditions in excess of those given in the operational sections of this document. Exposure to absolute maximum ratings for extended periods of the time can adversely affect reliability.

(1) Refer to reflow profile for soldering conditions for surface mounted devices.

ELECTRICAL CHARACTERISTICS ( $T_{amb} = 25\text{ }^{\circ}\text{C}$ , unless otherwise specified)						
PARAMETER	TEST CONDITION	SYMBOL	MIN.	TYP.	MAX.	UNIT
<b>INPUT</b>						
LED forward current, switch turn-on	$I_L = 100\text{ mA}, t = 10\text{ ms}$	$I_{Fon}$		1.1	2	mA
LED forward current, switch turn-off	$V_L = \pm 300\text{ V}$	$I_{Foff}$	0.2	0.6		mA
LED forward voltage	$I_F = 10\text{ mA}$	$V_F$	1	1.18	1.45	V
<b>OUTPUT</b>						
On-resistance, AC/DC: pin 3 ( $\pm$ ) to 4 ( $\pm$ )	$I_F = 5\text{ mA}, I_L = 50\text{ mA}$	$R_{ON}$		28	35	$\Omega$
Off-resistance	$I_F = 0\text{ mA}, V_L = \pm 100\text{ V}$	$R_{OFF}$	0.5	5000		$\text{G}\Omega$
Off-state leakage current	$I_F = 0\text{ mA}, V_L = \pm 100\text{ V}$	$I_O$		0.32	200	nA
	$I_F = 0\text{ mA}, V_L = \pm 350\text{ V}$	$I_O$			1	nA
Output capacitance pin 3 to 4	$I_F = 0\text{ mA}, V_L = 1\text{ V}$	$C_O$		55		pF
	$I_F = 0\text{ mA}, V_L = 50\text{ V}$	$C_O$		10		pF
Current limit	$I_F = 5\text{ mA}, t = 5\text{ ms}, V_L = \pm 6\text{ V}$	$I_{limit}$	170	210	250	mA
<b>TRANSFER</b>						
Capacitance (input to output)	$V_{ISO} = 1\text{ V}$	$C_{IO}$		0.6		pF

**Note**

- Minimum and maximum values are testing requirements. Typical values are characteristics of the device and are the result of engineering evaluations. Typical values are for information only and are not part of the testing requirements.

SWITCHING CHARACTERISTICS ( $T_{amb} = 25\text{ }^{\circ}\text{C}$ , unless otherwise specified)						
PARAMETER	TEST CONDITION	SYMBOL	MIN.	TYP.	MAX.	UNIT
Turn-on time	$I_F = 5\text{ mA}, I_L = 50\text{ mA}$	$t_{on}$		2	3	ms
Turn-off time	$I_F = 5\text{ mA}, I_L = 50\text{ mA}$	$t_{off}$		0.08	3	ms



TYPICAL CHARACTERISTICS (T<sub>amb</sub> = 25 °C, unless otherwise specified)

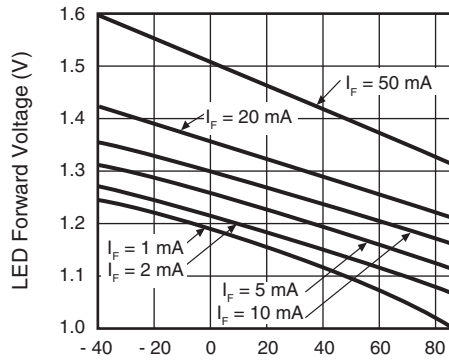

ih1546aef\_01 T<sub>A</sub> - Ambient Temperature (°C)

Fig. 1 - LED Voltage vs. Temperature

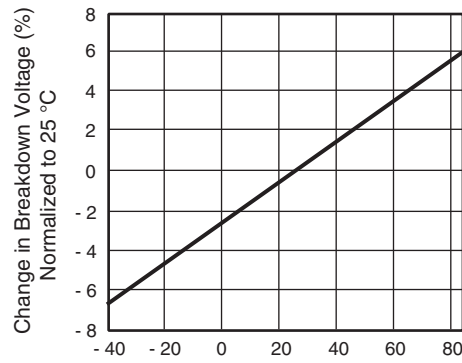

ih1546aef\_05

Fig. 4 - Switch Breakdown Voltage vs. Temperature

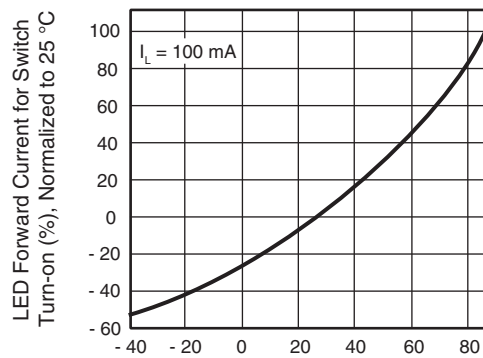

ih1546aef\_02

Fig. 2 - LED Current for Switch Turn-on vs. Temperature

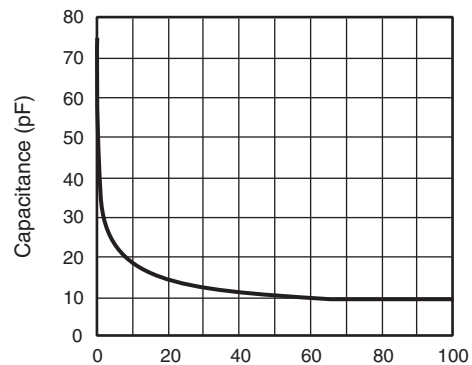

ih1546aef\_06

Fig. 5 - Switch Capacitance vs. Applied Voltage

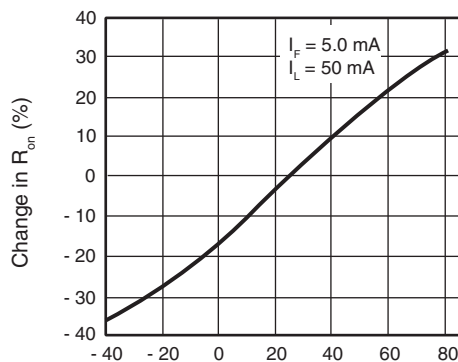

ih1546aef\_03

Fig. 3 - On-Resistance vs. Temperature

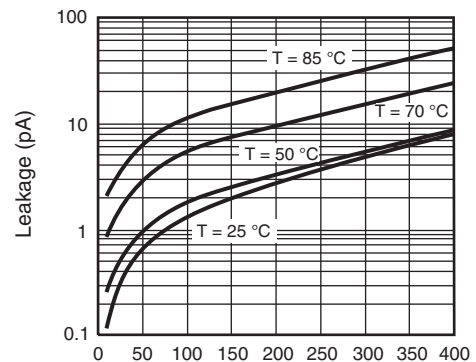

ih1546aef\_07

Fig. 6 - Leakage Current vs. Applied Voltage

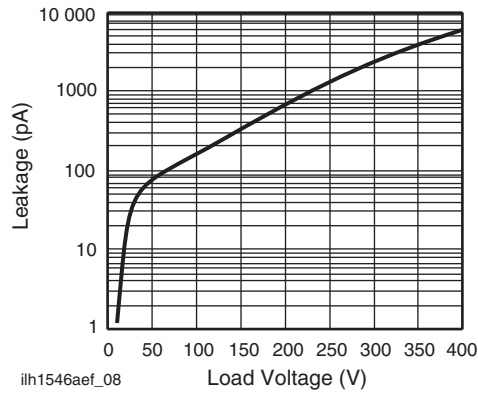

Fig. 7 - Leakage Current vs. Applied Voltage

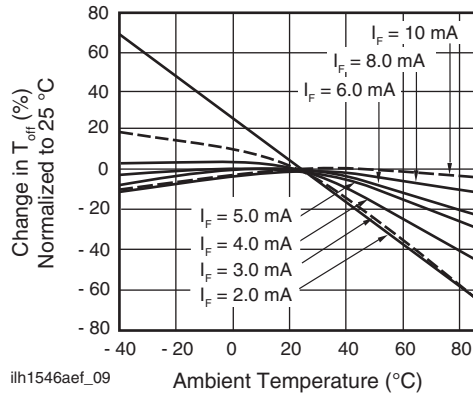

Fig. 8 - Turn-off Time vs. Temperature

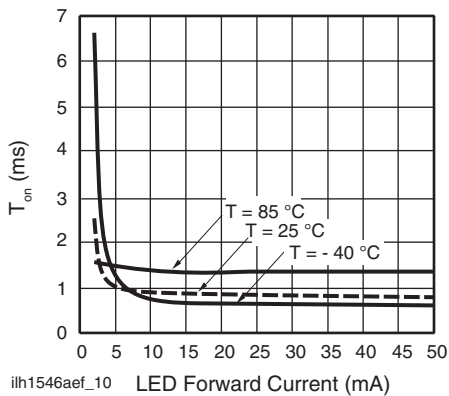
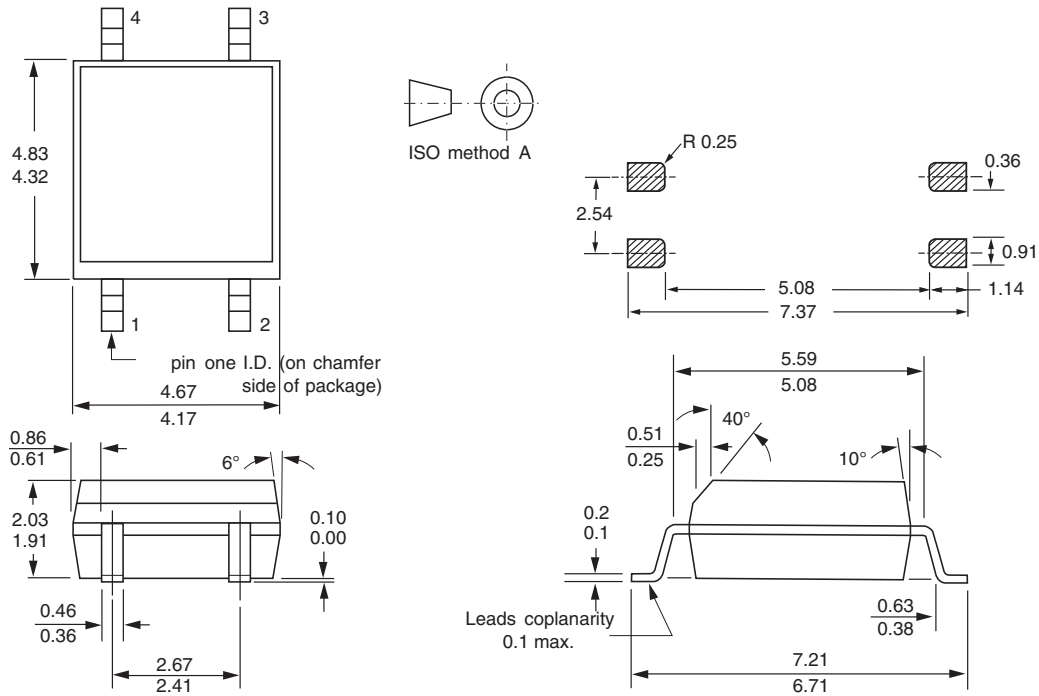

Fig. 9 - Turn-on Time vs. LED Current



## PACKAGE DIMENSIONS in millimeters



i178030

## PACKAGE MARKING (example)

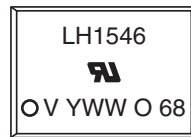

### Note

- Tape and reel suffix (TR) is not part of the package marking.



## Disclaimer

ALL PRODUCT, PRODUCT SPECIFICATIONS AND DATA ARE SUBJECT TO CHANGE WITHOUT NOTICE TO IMPROVE RELIABILITY, FUNCTION OR DESIGN OR OTHERWISE.

Vishay Intertechnology, Inc., its affiliates, agents, and employees, and all persons acting on its or their behalf (collectively, "Vishay"), disclaim any and all liability for any errors, inaccuracies or incompleteness contained in any datasheet or in any other disclosure relating to any product.

Vishay makes no warranty, representation or guarantee regarding the suitability of the products for any particular purpose or the continuing production of any product. To the maximum extent permitted by applicable law, Vishay disclaims (i) any and all liability arising out of the application or use of any product, (ii) any and all liability, including without limitation special, consequential or incidental damages, and (iii) any and all implied warranties, including warranties of fitness for particular purpose, non-infringement and merchantability.

Statements regarding the suitability of products for certain types of applications are based on Vishay's knowledge of typical requirements that are often placed on Vishay products in generic applications. Such statements are not binding statements about the suitability of products for a particular application. It is the customer's responsibility to validate that a particular product with the properties described in the product specification is suitable for use in a particular application. Parameters provided in datasheets and/or specifications may vary in different applications and performance may vary over time. All operating parameters, including typical parameters, must be validated for each customer application by the customer's technical experts. Product specifications do not expand or otherwise modify Vishay's terms and conditions of purchase, including but not limited to the warranty expressed therein.

Except as expressly indicated in writing, Vishay products are not designed for use in medical, life-saving, or life-sustaining applications or for any other application in which the failure of the Vishay product could result in personal injury or death. Customers using or selling Vishay products not expressly indicated for use in such applications do so at their own risk and agree to fully indemnify and hold Vishay and its distributors harmless from and against any and all claims, liabilities, expenses and damages arising or resulting in connection with such use or sale, including attorneys fees, even if such claim alleges that Vishay or its distributor was negligent regarding the design or manufacture of the part. Please contact authorized Vishay personnel to obtain written terms and conditions regarding products designed for such applications.

No license, express or implied, by estoppel or otherwise, to any intellectual property rights is granted by this document or by any conduct of Vishay. Product names and markings noted herein may be trademarks of their respective owners.

Компания «Life Electronics» занимается поставками электронных компонентов импортного и отечественного производства от производителей и со складов крупных дистрибьюторов Европы, Америки и Азии.

С конца 2013 года компания активно расширяет линейку поставок компонентов по направлению коаксиальный кабель, кварцевые генераторы и конденсаторы (керамические, пленочные, электролитические), за счёт заключения дистрибьюторских договоров

Мы предлагаем:

- Конкуренспособные цены и скидки постоянным клиентам.
- Специальные условия для постоянных клиентов.
- Подбор аналогов.
- Поставку компонентов в любых объемах, удовлетворяющих вашим потребностям.
- Приемлемые сроки поставки, возможна ускоренная поставка.
- Доставку товара в любую точку России и стран СНГ.
- Комплексную поставку.
- Работу по проектам и поставку образцов.
- Формирование склада под заказчика.
- Сертификаты соответствия на поставляемую продукцию (по желанию клиента).
- Тестирование поставляемой продукции.
- Поставку компонентов, требующих военную и космическую приемку.
- Входной контроль качества.
- Наличие сертификата ISO.

В составе нашей компании организован Конструкторский отдел, призванный помогать разработчикам, и инженерам.

Конструкторский отдел помогает осуществить:

- Регистрацию проекта у производителя компонентов.
- Техническую поддержку проекта.
- Защиту от снятия компонента с производства.
- Оценку стоимости проекта по компонентам.
- Изготовление тестовой платы монтаж и пусконаладочные работы.



Тел: +7 (812) 336 43 04 (многоканальный)  
Email: [org@lifeelectronics.ru](mailto:org@lifeelectronics.ru)