

# Telpower® Fused Disconnect Switch TP15900-4

## DC Distribution/Protection System - Rear Access



**SYSTEM:** TP15900-4 Fused Disconnect Switch and TPA Series Fuses

**CATALOG SYMBOL:** TP15900-4

**ELECTRICAL RATING:** 4-poles, 40A per pole at 145V DC  
50A per pole at 80V DC

**APPROVALS:**

U.L. recognized as a disconnect switch for interruption of load current by means of withdrawing the fuse carrier.

U.L. recognized as a component for telecommunication power distribution equipment (U.L. category QPQY2).

U.L. recognized fuses for branch circuit protection.

C.S.A. component acceptance for the system.

**FUSE TYPE:**

Fuse Type	TPA	TPA-B
Current	3, 5, 10, 15, 20, 25, 30, 40, 50	20, 25
Voltage	170V DC	65V DC
Interrupting	100 kA	20 kA

UL Recognized Guide JFHR2, File E56412,

CSA Certified Class 1422-30, File 53787

**FEATURES:**

- Recognized branch circuit protection device.
- Modular design - 4 poles per module.
- Ease of installation-Connection directly to bus bar.
- Eliminates external wiring per pole.
- LED alarm signaling (LED current 30mA max.).
- Blown fuse indication.
- Alarm test probe point, to allow on-site checking of alarm circuitry.
- Standard 0.25" QC terminal for alarm circuit connections.
- Bi-polar LED provides capability for both -48V DC and +24V DC applications.
- Fuse presence indication.
- Fuse orientation rejection feature.
- Rear accessibility for line and load terminations.
- Totally enclosed module - no moving parts.
- Material: U.L. rated 94V-0, 140°C rated.

**Dimensional Data:**

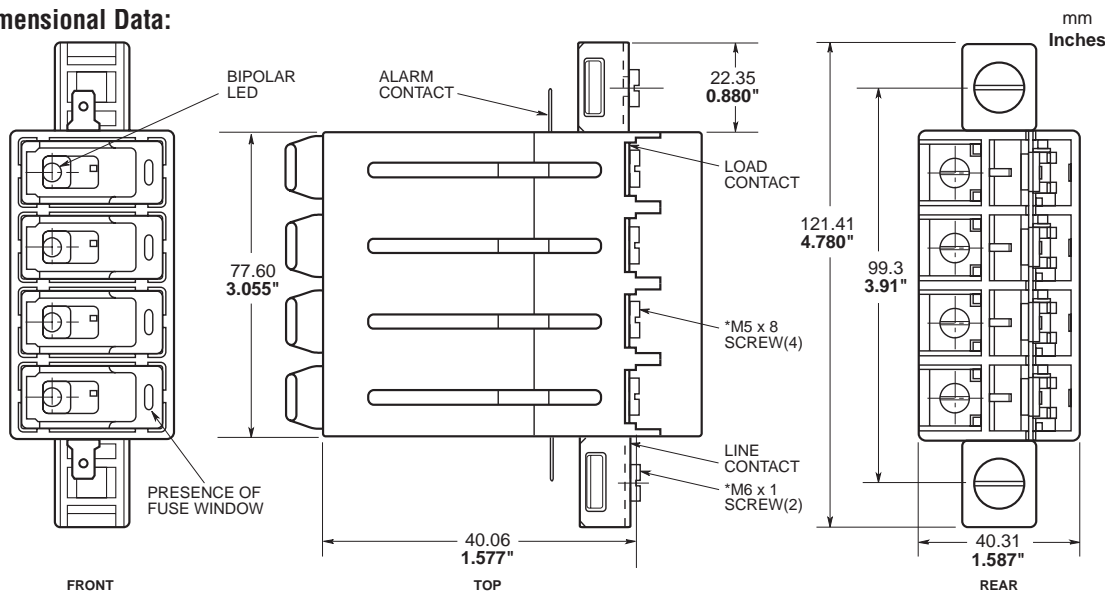

\*Recommended screw size (not included).

The only controlled copy of this BIF document is the electronic read-only version located on the Bussmann Network Drive. All other copies of this BIF document are by definition uncontrolled. This bulletin is intended to clearly present comprehensive product data and provide technical information that will help the end user with design applications. Bussmann reserves the right, without notice, to change design or construction of any products and to discontinue or limit distribution of any products. Bussmann also reserves the right to change or update, without notice, any technical information contained in this bulletin. Once a product has been selected, it should be tested by the user in all possible applications.

# Telpower® Fused Disconnect Switch DC Distribution/Protection System

## TP15900-4

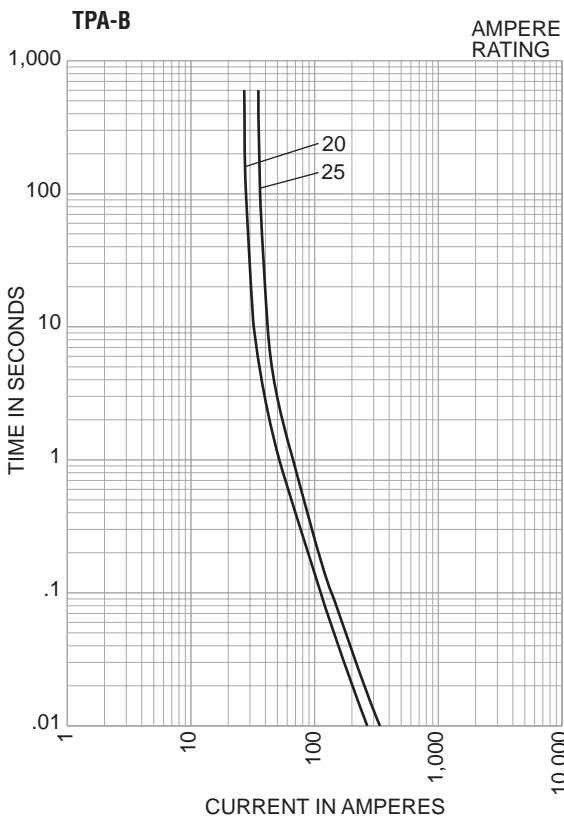
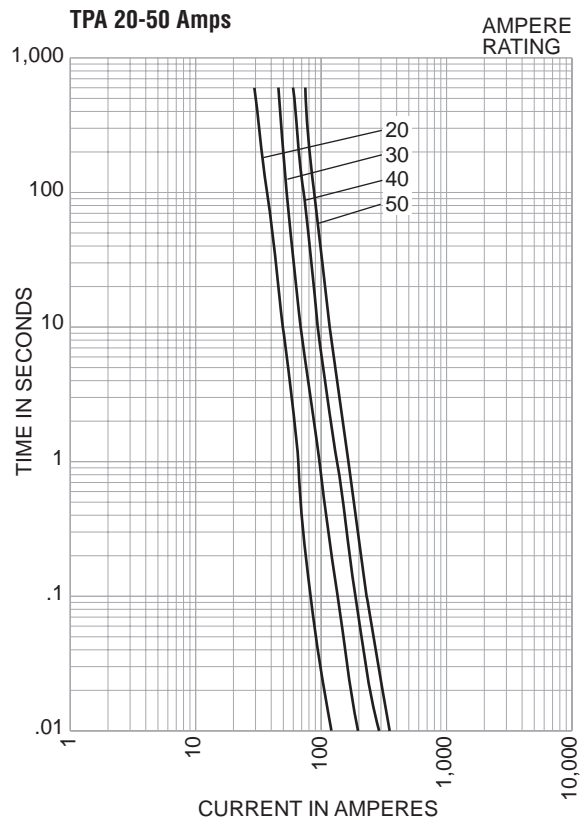
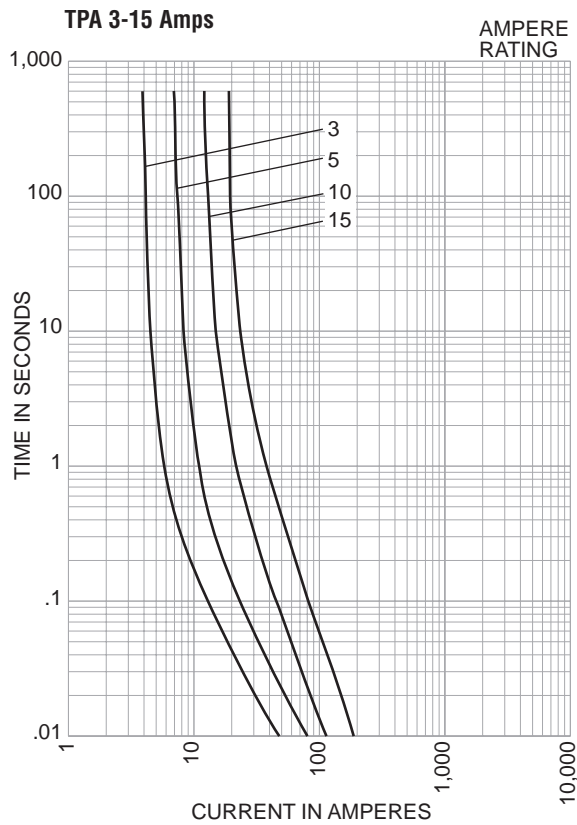

**Dimensional Data for TPA Fuses**

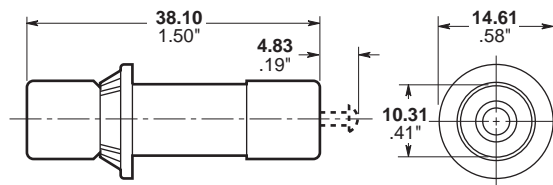

**Five Position Spare Fuseholder Part No. 5TPH**

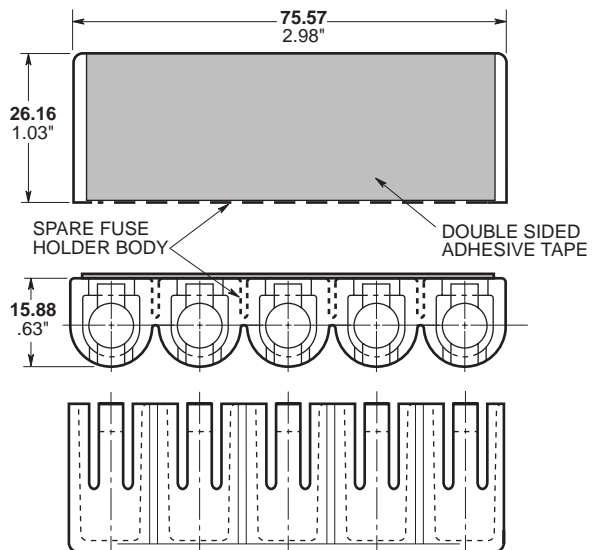

# Telpower® Fused Disconnect Switch

## DC Distribution/Protection System

# TP15900-4

Proper sizing of the current limiting resistor, referred to as  $R_{ALARM}$  in the diagram below, is essential to prevent excessive current, which could cause damage to the LED in the disconnect head, from passing through the remote alarm circuit. Because the LED is in series with the remote alarm circuit, the maximum available alarm circuit current should be limited to no more than 30 mA. This is the maximum sustained current that can be tolerated by the LED. It is important to note that when calculating the size of the resistor, the number of circuits in parallel on the remote alarm circuit is irrelevant. The resistor value should always be calculated assuming that the total available alarm circuit current is conducted through a single LED. This will insure that the 30 mA limitation is not exceeded. The calculations required to determine both the resistance and the wattage rating of  $R_{ALARM}$  are shown below.

By calculating the minimum value of  $R_{ALARM}$  as described above, the maximum available remote alarm circuit current will not exceed 30 mA. In the event of multiple fuse blows, where the fuses are connected in parallel on the same remote alarm bus, the total available remote alarm circuit current will be evenly divided between each of the LED's. For example, if three fuses blow, each LED, indicating the presence of a blown fuse, will conduct approximately 10 mA each, assuming the total available remote alarm circuit current is 30mA.

METHOD FOR CALCULATING THE MINIMUM SERIES RESISTANCE VALUE NECESSARY TO LIMIT THE AVAILABLE ALARM CIRCUIT CURRENT TO  $\leq 30\text{mA}$ . THE MINIMUM RESISTOR WATTAGE CALCULATIONS IS ALSO SHOWN.

$$R_{ALARM} = \frac{V_{SYSTEM}}{I_{LED}} \quad (\text{where } I_{LED} - 30 \text{ mA max.})$$

$$P_{RALARM} = (V_{SYSTEM})(I_{LED}) \quad (\text{where } I_{LED} - 30 \text{ mA max.})$$

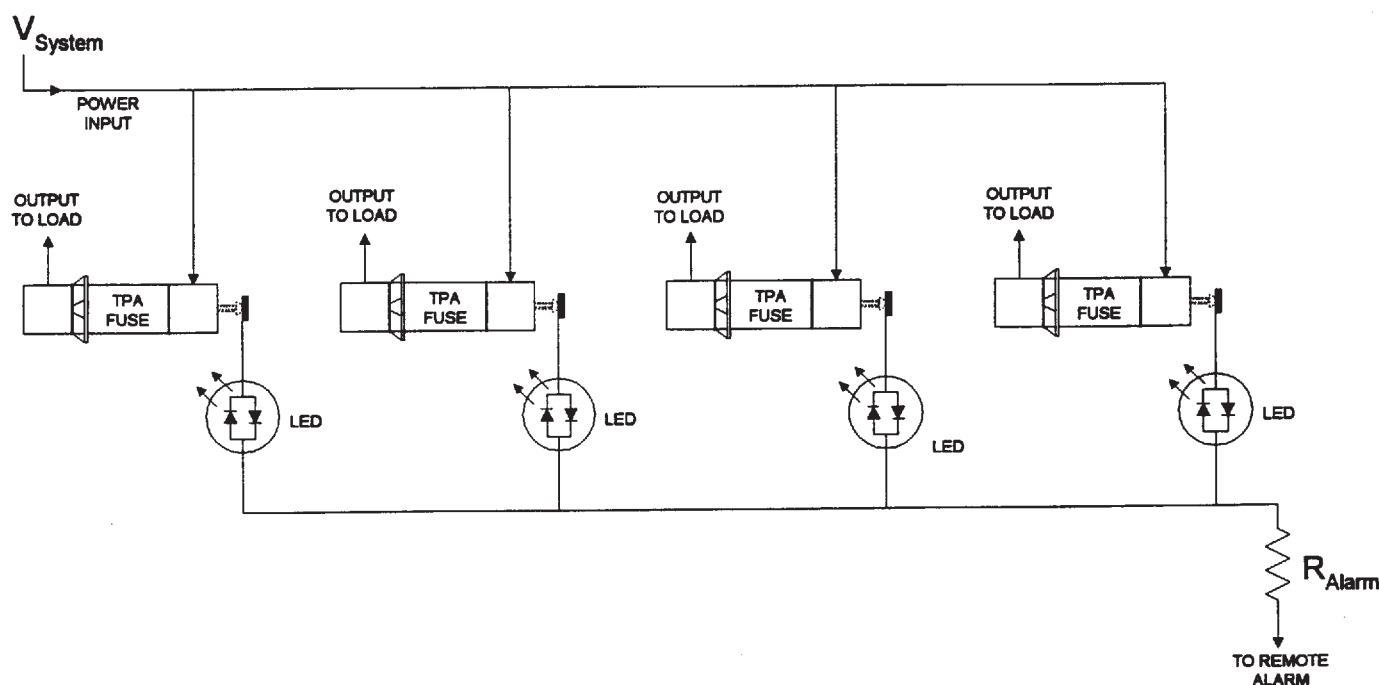

Компания «Life Electronics» занимается поставками электронных компонентов импортного и отечественного производства от производителей и со складов крупных дистрибьюторов Европы, Америки и Азии.

С конца 2013 года компания активно расширяет линейку поставок компонентов по направлению коаксиальный кабель, кварцевые генераторы и конденсаторы (керамические, пленочные, электролитические), за счёт заключения дистрибьюторских договоров

Мы предлагаем:

- Конкурентоспособные цены и скидки постоянным клиентам.
- Специальные условия для постоянных клиентов.
- Подбор аналогов.
- Поставку компонентов в любых объемах, удовлетворяющих вашим потребностям.
- Приемлемые сроки поставки, возможна ускоренная поставка.
- Доставку товара в любую точку России и стран СНГ.
- Комплексную поставку.
- Работу по проектам и поставку образцов.
- Формирование склада под заказчика.
- Сертификаты соответствия на поставляемую продукцию (по желанию клиента).
- Тестирование поставляемой продукции.
- Поставку компонентов, требующих военную и космическую приемку.
- Входной контроль качества.
- Наличие сертификата ISO.

В составе нашей компании организован Конструкторский отдел, призванный помогать разработчикам, и инженерам.

Конструкторский отдел помогает осуществить:

- Регистрацию проекта у производителя компонентов.
- Техническую поддержку проекта.
- Защиту от снятия компонента с производства.
- Оценку стоимости проекта по компонентам.
- Изготовление тестовой платы монтаж и пусконаладочные работы.



Тел: +7 (812) 336 43 04 (многоканальный)  
Email: [org@lifeelectronics.ru](mailto:org@lifeelectronics.ru)