



THERMALCARE FAN TRAYS



MODEL NUMBER	PART NUMBER	VOLTAGE	FANS	CFM
AC FAN TRAYS				
OA300S	FTA-03115-014(BK)	115VAC	3	330
OA600S	FTA-06115-014(BK)		6	660
OA300	FTA-03115-018(BK)		3	330
OA300-A	expansion module		3	330
OA600	FTA-06115-018(BK)		6	660
OA900	FTA-09115-018(BK)		9	990
OA302S	FTA-03220-014(BK)	230VAC	3	330
OA602S	FTA-06220-014(BK)		6	660
OA302	FTA-03220-018(BK)		3	330
OA302-A	expansion module		3	330
OA602	FTA-06220-018(BK)		6	660
OA902	FTA-09220-018(BK)		9	990
DUAL VOLTAGE AC TRAYS				
OA300S-DV	FTA-03DV-014(BK)	115/230VAC	3	330
OA600S-DV	FTA-06DV-014(BK)		6	660
OA300-DV	FTA-03DV-018(BK)		3	330
OA300DV-A	expansion module		3	330
OA600-DV	FTA-06DV-018(BK)		6	660
OA900-DV	FTA-09DV-018(BK)		9	990
DC FAN TRAYS				
OD300S-12	FTD-03012-014(BK)	12VDC	3	330
OD600S-12	FTD-06012-014(BK)		6	660
OD300-12	FTD-03012-018(BK)		3	330
OD300-12-A	expansion module		3	330
OD600-12	FTD-06012-018(BK)		6	660
OD900-12	FTD-09012-018(BK)		9	990
OD300S-24	FTD-03024-014(BK)	24VDC	3	330
OD600S-24	FTD-06024-014(BK)		6	660
OD300-24	FTD-03024-018(BK)		3	330
OD300-24-A	expansion module		3	330
OD600-24	FTD-06024-018(BK)		6	660
OD900-24	FTD-09024-018(BK)		9	990
OD300S-48	FTD-03048-014(BK)	48VDC	3	330
OD300-48-A	expansion module		3	330
OD600S-48	FTD-06048-014(BK)		6	660
OD300-48	FTD-03048-018(BK)		3	330
OD600-48	FTD-06048-018(BK)		6	660
OD900-48	FTD-09048-018(BK)		9	990

Fan trays are UL listed by the part number only. Model numbers are assigned as configuration descriptors only and do not affect UL certifications.

BASIC FAN TRAY SPECIFICATIONS...

FRAME

Heavy Duty steel construction with extruded aluminum side rails. Black color standard, gray available by special order.

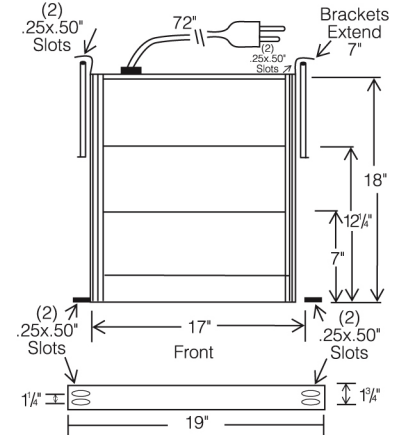

HARDWARE

EZ-mount clip nuts and fasteners

CONFIGURATION

Standard trays have 3, 6 or 9 fans installed. Our ADD-a-MODULE feature allows the user to easily increase or decrease the amount of cooling in 3-fan increments.

OPTIONS

Ultrashort 3-fan Tray available. Lighted on/off rocker switch. Dual voltage selector switch. Fan monitor and alarm. MEDIUM AND LOW SPEED FANS CAN BE SUBSTITUTED FOR LOW-NOISE APPLICATIONS. Ultra high speed fans are available.

We use only top quality, ball bearing ORION FANS in our fan tray assemblies. For DC applications plastic fans are standard however diecast aluminum fans can be substituted on request. (Minimums apply.)

We can customize our fan trays to perform virtually any function required. If you need something which does not appear in this catalog just let us know. Our sales engineers will be happy to discuss your needs and provide a solution.



POWER CONNECTION

AC trays have standard 115 or 230 VAC power cords. DC trays come with standard DC screw terminals.



115VAC



230VAC



Dual Voltage
(IEC320 C14)

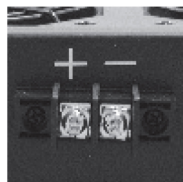

DC Power



ORION STANDARD TRAY

L=19" W=19" D=1.75" with IEC320, C14-type connector on back. 115/230 voltage selector included with dual voltage tray.

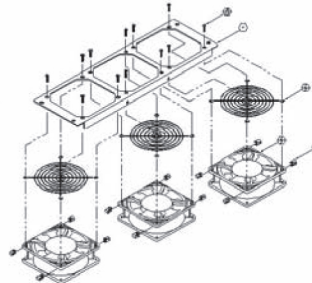
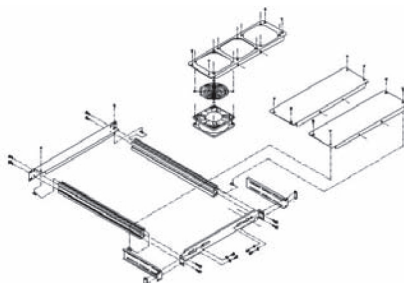
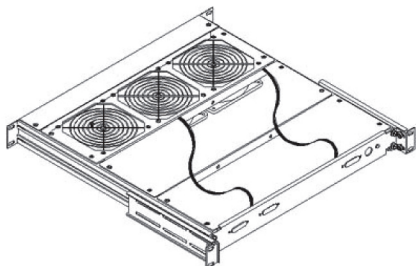

Standard trays are populated with high speed, ball bearing fans. We can substitute virtually any 120mm AC or DC fan for your special project. Just let your sales engineer know what your requirements are and he or she will be happy to provide a solution.

CUSTOM TRAYS

ORION FANS fan trays are available in dozens of stock configurations. If you cannot find what you are looking for give us a call. We can design and build your trays from scratch or we can help you come up with solutions for your toughest problems.



ORION SHORT TRAY

L=14" W=19" D=1.75". Optional lighted on/off rocker with IEC320, C14-type connector on back. 115/230 voltage selector included with dual voltage tray.



Dual Voltage Selector

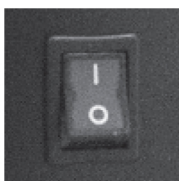

Lighted on/off rocker



Warning Lights

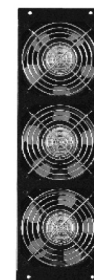
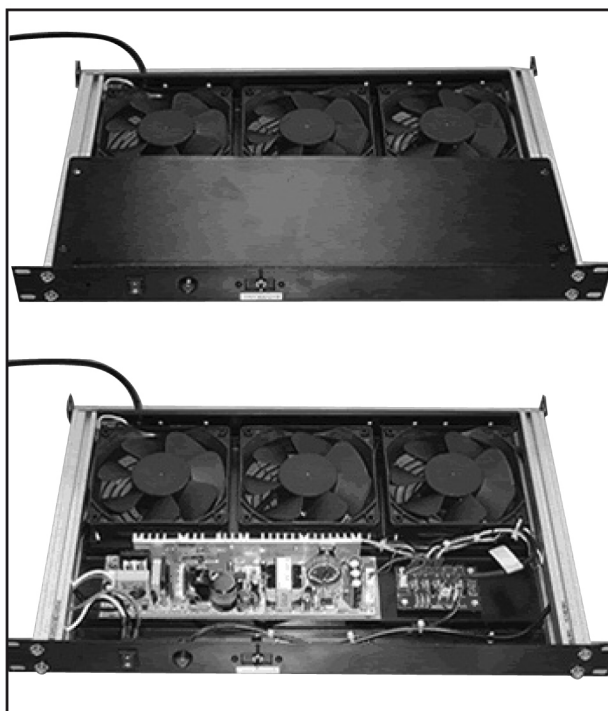

EXPANSION MODULE

Maximum flexibility - minimum effort. Add or subtract fan modules quickly and easily as your cooling needs change.

Компания «Life Electronics» занимается поставками электронных компонентов импортного и отечественного производства от производителей и со складов крупных дистрибьюторов Европы, Америки и Азии.

С конца 2013 года компания активно расширяет линейку поставок компонентов по направлению коаксиальный кабель, кварцевые генераторы и конденсаторы (керамические, пленочные, электролитические), за счёт заключения дистрибьюторских договоров

Мы предлагаем:

- Конкурентоспособные цены и скидки постоянным клиентам.
- Специальные условия для постоянных клиентов.
- Подбор аналогов.
- Поставку компонентов в любых объемах, удовлетворяющих вашим потребностям.
- Приемлемые сроки поставки, возможна ускоренная поставка.
- Доставку товара в любую точку России и стран СНГ.
- Комплексную поставку.
- Работу по проектам и поставку образцов.
- Формирование склада под заказчика.
- Сертификаты соответствия на поставляемую продукцию (по желанию клиента).
- Тестирование поставляемой продукции.
- Поставку компонентов, требующих военную и космическую приемку.
- Входной контроль качества.
- Наличие сертификата ISO.

В составе нашей компании организован Конструкторский отдел, призванный помогать разработчикам, и инженерам.

Конструкторский отдел помогает осуществить:

- Регистрацию проекта у производителя компонентов.
- Техническую поддержку проекта.
- Защиту от снятия компонента с производства.
- Оценку стоимости проекта по компонентам.
- Изготовление тестовой платы монтаж и пусконаладочные работы.



Тел: +7 (812) 336 43 04 (многоканальный)

Email: org@lifeelectronics.ru