

NL17SZ04

Single Inverter

The NL17SZ04 is an inverter in two tiny footprint packages. The device performs much as LCX multi-gate products in speed and drive.

Features

- Tiny SOT-353 and SOT-553 Packages
- 24 mA Sink and Source Output Capability
- Over-Voltage Tolerant Inputs and Outputs
- Pin For Pin with NC7SZ04P5X, TC7SZ04FU and TC7SZ04AFE
- Chip Complexity: FETs = 20
- Designed for 1.65 V to 5.5 V V_{CC} Operation
- NLV Prefix for Automotive and Other Applications Requiring Unique Site and Control Change Requirements; AEC-Q100 Qualified and PPAP Capable
- These Devices are Pb-Free and are RoHS Compliant

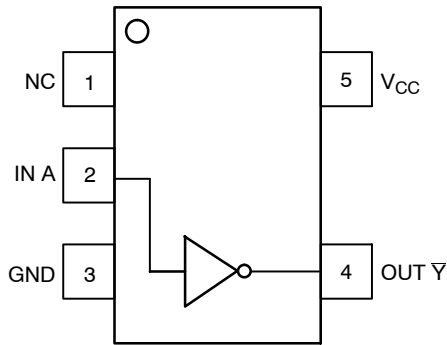

Figure 1. Pinout (Top View)

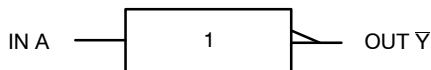
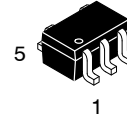

Figure 2. Logic Symbol



ON Semiconductor®

<http://onsemi.com>



SOT-353/SC70-5/SC-88A
DF SUFFIX
CASE 419A

MARKING DIAGRAMS

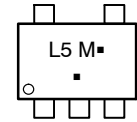

L5 = Specific Device Marking

M = Date Code*

▪ = Pb-Free Package

(Note: Microdot may be in either location)

*Date Code orientation and/or position may vary depending upon manufacturing location.

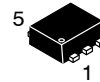

SOT-553
XV5 SUFFIX
CASE 463B

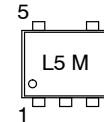

L5 = Specific Device Marking

M = Date Code

PIN ASSIGNMENT

| Pin | Function |
|-----|---------------|
| 1 | NC |
| 2 | IN A |
| 3 | GND |
| 4 | OUT \bar{Y} |
| 5 | V_{CC} |

FUNCTION TABLE

| A Input | \bar{Y} Output |
|---------|------------------|
| L | H |
| H | L |

ORDERING INFORMATION

See detailed ordering and shipping information in the package dimensions section on page 4 of this data sheet.

NL17SZ04

MAXIMUM RATINGS

| Symbol | Parameter | Value | Unit |
|----------------------|--|------------------------------|------|
| V _{CC} | DC Supply Voltage | -0.5 to +7.0 | V |
| V _I | DC Input Voltage | -0.5 ≤ V _I ≤ +7.0 | V |
| V _O | DC Output Voltage Output in Higher or Low State (Note 1) | -0.5 ≤ V _O ≤ +7.0 | V |
| I _{IK} | DC Input Diode Current V _I < GND | -50 | mA |
| I _{OK} | DC Output Diode Current V _O < GND | -50 | mA |
| I _O | DC Output Sink Current | ±50 | mA |
| I _{CC} | DC Supply Current per Supply Pin | ±100 | mA |
| I _{GND} | DC Ground Current per Supply Pin | ±100 | mA |
| T _{STG} | Storage Temperature Range | -65 to +150 | °C |
| T _L | Lead Temperature, 1 mm from Case for 10 Seconds | 260 | °C |
| T _J | Junction Temperature Under Bias | +150 | °C |
| θ _{JA} | Thermal Resistance SOT-353 (Note 2) SOT-553 | 350 496 | °C/W |
| P _D | Power Dissipation in Still Air at 85°C SOT-353 SOT-553 | 186 135 | mW |
| MSL | Moisture Sensitivity | Level 1 | |
| F _R | Flammability Rating Oxygen Index: 28 to 34 | UL 94 V-0 @ 0.125 in | |
| ESD | ESD Classification Human Body Model (Note 3) Machine Model (Note 4) Charged Device Model (Note 5) | Class 2 Class C N/A | |
| I _{LATCHUP} | Latchup Performance Above V _{CC} and Below GND at 125°C (Note 6) | ±100 | mA |

Stresses exceeding Maximum Ratings may damage the device. Maximum Ratings are stress ratings only. Functional operation above the Recommended Operating Conditions is not implied. Extended exposure to stresses above the Recommended Operating Conditions may affect device reliability.

1. IO absolute maximum rating must be observed.
2. Measured with minimum pad spacing on an FR4 board, using 10 mm-by-1 inch, 2-ounce copper trace with no air flow.
3. Tested to EIA/JESD22-A114-A, rated to EIA/JESD22-A114-B.
4. Tested to EIA/JESD22-A115-A, rated to EIA/JESD22-A115-A.
5. Tested to JESD22-C101-A.
6. Tested to EIA/JESD78.

RECOMMENDED OPERATING CONDITIONS

| Symbol | Parameter | Min | Max | Unit |
|---------------------------------|---|-------------|---------------|------|
| V _{CC} | DC Supply Voltage Operating Data Retention | 1.65 1.5 | 5.5 5.5 | V |
| V _{IN} | DC Input Voltage | 0 | 5.5 | V |
| V _{OUT} | DC Output Voltage (High or Low State) | 0 | 5.5 | V |
| T _A | Operating Temperature Range | -55 | +125 | °C |
| t _r , t _f | Input Rise and Fall Time V _{CC} = 2.5 V ± 0.2 V V _{CC} = 3.0 V ± 0.3 V V _{CC} = 5.0 V ± 0.5 V | 0 0 0 | 20 10 5 | ns/V |

NL17SZ04

DC ELECTRICAL CHARACTERISTICS

| Symbol | Parameter | Condition | V _{CC} (V) | T _A = 25°C | | | -55°C ≤ T _A ≤ 125°C | | Unit |
|------------------|--|---|----------------------------|---|-----------------|---|---|---|------|
| | | | | Min | Typ | Max | Min | Max | |
| V _{IH} | High-Level Input Voltage | | 1.65 to 1.95 2.3 to 5.5 | 0.75 V _{CC} 0.7 V _{CC} | | | 0.75 V _{CC} 0.7 V _{CC} | | V |
| V _{IL} | Low-Level Input Voltage | | 1.65 to 1.95 2.3 to 5.5 | | | 0.25 V _{CC} 0.3 V _{CC} | | 0.25 V _{CC} 0.3 V _{CC} | V |
| V _{OH} | High-Level Output Voltage V _{IN} = V _{IL} | I _{OH} = -100 μA | 1.65 to 5.5 | V _{CC} - 0.1 | V _{CC} | | V _{CC} - 0.1 | | V |
| | | I _{OH} = -3 mA | 1.65 | 1.29 | 1.52 | | 1.29 | | |
| | | I _{OH} = -8 mA | 2.3 | 1.9 | 2.1 | | 1.9 | | |
| | | I _{OH} = -12 mA | 2.7 | 2.2 | 2.4 | | 2.2 | | |
| | | I _{OH} = -16 mA | 3.0 | 2.4 | 2.7 | | 2.4 | | |
| | | I _{OH} = -24 mA | 3.0 | 2.3 | 2.5 | | 2.3 | | |
| | | I _{OH} = -32 mA | 4.5 | 3.8 | 4.0 | | 3.8 | | |
| V _{OL} | Low-Level Output Voltage V _{IN} = V _{IH} | I _{OL} = 100 μA | 1.65 to 5.5 | | 0.0 | 0.1 | | 0.1 | V |
| | | I _{OH} = 3 mA | 1.65 | | 0.08 | 0.24 | | 0.24 | |
| | | I _{OL} = 8 mA | 2.3 | | 0.20 | 0.3 | | 0.3 | |
| | | I _{OL} = 12 mA | 2.7 | | 0.22 | 0.4 | | 0.4 | |
| | | I _{OL} = 16 mA | 3.0 | | 0.28 | 0.4 | | 0.4 | |
| | | I _{OL} = 24 mA | 3.0 | | 0.38 | 0.55 | | 0.55 | |
| | | I _{OL} = 32 mA | 4.5 | | 0.42 | 0.55 | | 0.55 | |
| I _{IN} | Input Leakage Current | V _{IN} = 5.5 V or GND | 0 to 5.5 | | ±0.1 | | | ±1.0 | μA |
| I _{OFF} | Power Off Leakage Current | V _{IN} = 5.5 V or V _{OUT} = 5.5 V | 0 | | | 1 | | 10 | μA |
| I _{CC} | Quiescent Supply Current | V _{IN} = 5.5 V or GND | 5.5 | | | 1 | | 10 | μA |

AC ELECTRICAL CHARACTERISTICS t_R = t_F = 2.5 ns; C_L = 50 pF; R_L = 500 Ω

| Symbol | Parameter | Condition | V _{CC} (V) | T _A = 25°C | | | -55°C ≤ T _A ≤ 125°C | | Unit |
|---------------------------------------|---------------------------------------|--|---------------------|-----------------------|-----|------|--------------------------------|------|------|
| | | | | Min | Typ | Max | Min | Max | |
| t _{PLH} t _{PHL7} | Propagation Delay (Figure 3 and 4) | R _L = 1 MΩ, C _L = 15 pF | 1.65 | 2.0 | 5.3 | 11.4 | 2.0 | 12.0 | ns |
| | | | 1.8 | 2.0 | 4.4 | 9.5 | 2.0 | 10.0 | |
| | | R _L = 1 MΩ, C _L = 15 pF | 2.5 ± 0.2 | 0.2 | 3.5 | 6.5 | 0.8 | 7.0 | |
| | | R _L = 1 MΩ, C _L = 15 pF | 3.3 ± 0.3 | 0.8 | 2.1 | 4.5 | 0.5 | 4.7 | |
| | | R _L = 500 Ω, C _L = 50 pF | | 1.2 | 2.9 | 5.5 | 1.5 | 5.2 | |
| | | R _L = 1 MΩ, C _L = 15 pF | 5.0 ± 0.5 | 0.5 | 1.8 | 3.9 | 0.5 | 4.1 | |
| | | R _L = 500 Ω, C _L = 50 pF | | 0.8 | 2.4 | 4.3 | 0.8 | 4.5 | |

CAPACITIVE CHARACTERISTICS

| Symbol | Parameter | Condition | Typical | Unit |
|-----------------|--|--|---------|------|
| C _{IN} | Input Capacitance | V _{CC} = 5.5 V, V _I = 0 V or V _{CC} | > 2.5 | pF |
| C _{PD} | Power Dissipation Capacitance (Note 7) | 10 MHz, V _{CC} = 3.3 V, V _I = 0 V or V _{CC} 10 MHz, V _{CC} = 5.5 V, V _I = 0 V or V _{CC} | 9 11 | pF |

7. C_{PD} is defined as the value of the internal equivalent capacitance which is calculated from the operating current consumption without load. Average operating current can be obtained by the equation: I_{CC(OPR)} = C_{PD} • V_{CC} • f_{in} + I_{CC}. C_{PD} is used to determine the no-load dynamic power consumption; P_D = C_{PD} • V_{CC}² • f_{in} + I_{CC} • V_{CC}.

NL17SZ04

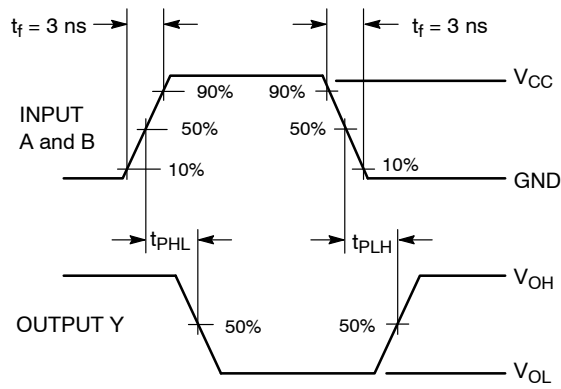
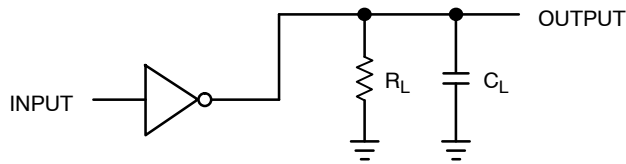

Figure 3. Switching Waveform



A 1-MHz square input wave is recommended for propagation delay tests.

Figure 4. Test Circuit

ORDERING INFORMATION

| Device | Package | Shipping [†] |
|-----------------|-------------------------------------|-----------------------|
| NL17SZ04DFT2G | SC-88A/SOT-353/SC-70-5 (Pb-Free) | 3000 / Tape & Reel |
| NLV17SZ04DFT2G* | SC-88A/SOT-353/SC-70-5 (Pb-Free) | 3000 / Tape & Reel |
| NL17SZ04XV5T2G | SOT-553 (Pb-Free) | 4000 / Tape & Reel |

[†]For information on tape and reel specifications, including part orientation and tape sizes, please refer to our Tape and Reel Packaging Specifications Brochure, BRD8011/D.

*NLV Prefix for Automotive and Other Applications Requiring Unique Site and Control Change Requirements; AEC-Q100 Qualified and PPAP Capable.

NL17SZ04

PACKAGE DIMENSIONS

SC-88A (SC-70-5/SOT-353)
CASE 419A-02
ISSUE L

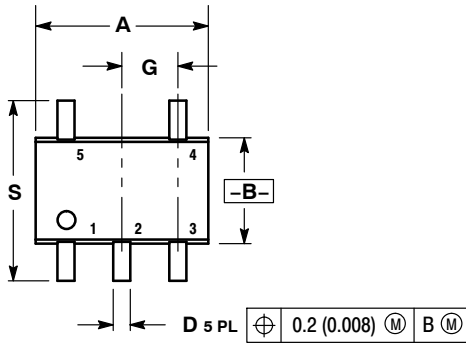

- NOTES:
1. DIMENSIONING AND TOLERANCING PER ANSI Y14.5M, 1982.
 2. CONTROLLING DIMENSION: INCH.
 3. 419A-01 OBSOLETE. NEW STANDARD 419A-02.
 4. DIMENSIONS A AND B DO NOT INCLUDE MOLD FLASH, PROTRUSIONS, OR GATE BURRS.

| DIM | INCHES | | MILLIMETERS | |
|-----|-----------|-------|-------------|------|
| | MIN | MAX | MIN | MAX |
| A | 0.071 | 0.087 | 1.80 | 2.20 |
| B | 0.045 | 0.053 | 1.15 | 1.35 |
| C | 0.031 | 0.043 | 0.80 | 1.10 |
| D | 0.004 | 0.012 | 0.10 | 0.30 |
| G | 0.026 BSC | | 0.65 BSC | |
| H | --- | 0.004 | --- | 0.10 |
| J | 0.004 | 0.010 | 0.10 | 0.25 |
| K | 0.004 | 0.012 | 0.10 | 0.30 |
| N | 0.008 REF | | 0.20 REF | |
| S | 0.079 | 0.087 | 2.00 | 2.20 |

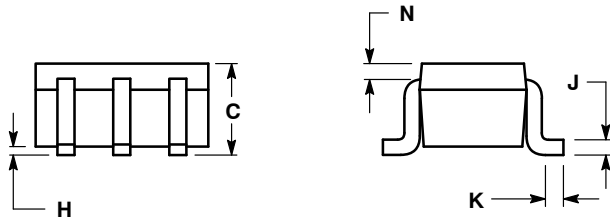

SOLDER FOOTPRINT*

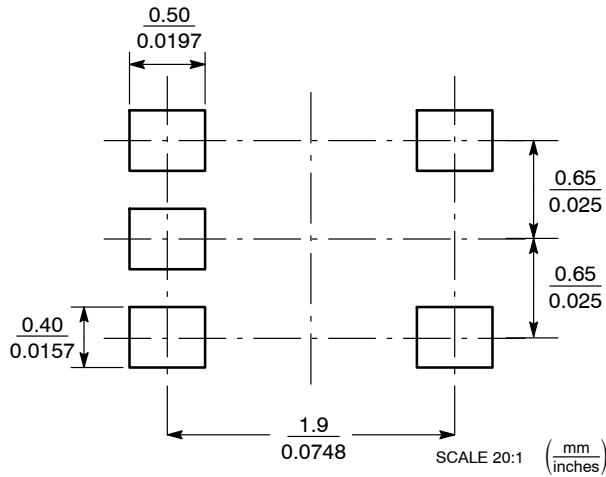

*For additional information on our Pb-Free strategy and soldering details, please download the ON Semiconductor Soldering and Mounting Techniques Reference Manual, SOLDERRM/D.

NL17SZ04

PACKAGE DIMENSIONS

SOT-553
XV5 SUFFIX
CASE 463B
ISSUE B

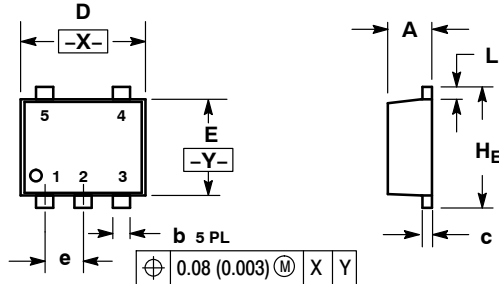

NOTES:

1. DIMENSIONING AND TOLERANCING PER ANSI Y14.5M, 1982.
2. CONTROLLING DIMENSION: MILLIMETERS
3. MAXIMUM LEAD THICKNESS INCLUDES LEAD FINISH THICKNESS. MINIMUM LEAD THICKNESS IS THE MINIMUM THICKNESS OF BASE MATERIAL.

| DIM | MILLIMETERS | | | INCHES | | |
|-----|-------------|------|------|-----------|-------|-------|
| | MIN | NOM | MAX | MIN | NOM | MAX |
| A | 0.50 | 0.55 | 0.60 | 0.020 | 0.022 | 0.024 |
| b | 0.17 | 0.22 | 0.27 | 0.007 | 0.009 | 0.011 |
| c | 0.08 | 0.13 | 0.18 | 0.003 | 0.005 | 0.007 |
| D | 1.50 | 1.60 | 1.70 | 0.059 | 0.063 | 0.067 |
| E | 1.10 | 1.20 | 1.30 | 0.043 | 0.047 | 0.051 |
| e | 0.50 BSC | | | 0.020 BSC | | |
| L | 0.10 | 0.20 | 0.30 | 0.004 | 0.008 | 0.012 |
| HE | 1.50 | 1.60 | 1.70 | 0.059 | 0.063 | 0.067 |

SOLDERING FOOTPRINT*

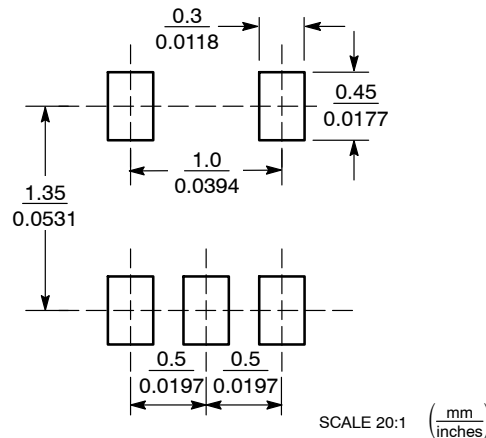

*For additional information on our Pb-Free strategy and soldering details, please download the ON Semiconductor Soldering and Mounting Techniques Reference Manual, SOLDERRM/D.

ON Semiconductor and are registered trademarks of Semiconductor Components Industries, LLC (SCILLC). SCILLC owns the rights to a number of patents, trademarks, copyrights, trade secrets, and other intellectual property. A listing of SCILLC's product/patent coverage may be accessed at www.onsemi.com/site/pdf/Patent-Marking.pdf. SCILLC reserves the right to make changes without further notice to any products herein. SCILLC makes no warranty, representation or guarantee regarding the suitability of its products for any particular purpose, nor does SCILLC assume any liability arising out of the application or use of any product or circuit, and specifically disclaims any and all liability, including without limitation special, consequential or incidental damages. "Typical" parameters which may be provided in SCILLC data sheets and/or specifications can and do vary in different applications and actual performance may vary over time. All operating parameters, including "Typicals" must be validated for each customer application by customer's technical experts. SCILLC does not convey any license under its patent rights nor the rights of others. SCILLC products are not designed, intended, or authorized for use as components in systems intended for surgical implant into the body, or other applications intended to support or sustain life, or for any other application in which the failure of the SCILLC product could create a situation where personal injury or death may occur. Should Buyer purchase or use SCILLC products for any such unintended or unauthorized application, Buyer shall indemnify and hold SCILLC and its officers, employees, subsidiaries, affiliates, and distributors harmless against all claims, costs, damages, and expenses, and reasonable attorney fees arising out of, directly or indirectly, any claim of personal injury or death associated with such unintended or unauthorized use, even if such claim alleges that SCILLC was negligent regarding the design or manufacture of the part. SCILLC is an Equal Opportunity/Affirmative Action Employer. This literature is subject to all applicable copyright laws and is not for resale in any manner.

PUBLICATION ORDERING INFORMATION

LITERATURE FULFILLMENT:

Literature Distribution Center for ON Semiconductor
P.O. Box 5163, Denver, Colorado 80217 USA
Phone: 303-675-2175 or 800-344-3860 Toll Free USA/Canada
Fax: 303-675-2176 or 800-344-3867 Toll Free USA/Canada
Email: orderlit@onsemi.com

N. American Technical Support: 800-282-9855 Toll Free
USA/Canada
Europe, Middle East and Africa Technical Support:
Phone: 421 33 790 2910
Japan Customer Focus Center
Phone: 81-3-5817-1050

ON Semiconductor Website: www.onsemi.com

Order Literature: <http://www.onsemi.com/orderlit>

For additional information, please contact your local Sales Representative

Компания «Life Electronics» занимается поставками электронных компонентов импортного и отечественного производства от производителей и со складов крупных дистрибьюторов Европы, Америки и Азии.

С конца 2013 года компания активно расширяет линейку поставок компонентов по направлению коаксиальный кабель, кварцевые генераторы и конденсаторы (керамические, пленочные, электролитические), за счёт заключения дистрибьюторских договоров

Мы предлагаем:

- Конкурентоспособные цены и скидки постоянным клиентам.
- Специальные условия для постоянных клиентов.
- Подбор аналогов.
- Поставку компонентов в любых объемах, удовлетворяющих вашим потребностям.
- Приемлемые сроки поставки, возможна ускоренная поставка.
- Доставку товара в любую точку России и стран СНГ.
- Комплексную поставку.
- Работу по проектам и поставку образцов.
- Формирование склада под заказчика.
- Сертификаты соответствия на поставляемую продукцию (по желанию клиента).
- Тестирование поставляемой продукции.
- Поставку компонентов, требующих военную и космическую приемку.
- Входной контроль качества.
- Наличие сертификата ISO.

В составе нашей компании организован Конструкторский отдел, призванный помогать разработчикам, и инженерам.

Конструкторский отдел помогает осуществить:

- Регистрацию проекта у производителя компонентов.
- Техническую поддержку проекта.
- Защиту от снятия компонента с производства.
- Оценку стоимости проекта по компонентам.
- Изготовление тестовой платы монтаж и пусконаладочные работы.



Тел: +7 (812) 336 43 04 (многоканальный)

Email: org@lifeelectronics.ru