

## Separate Construction with Minimal Depth

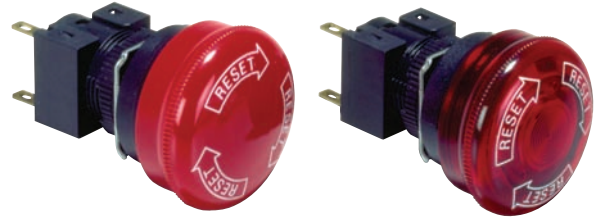

- Direct opening mechanism to open contacts in emergencies, such as when they are welded.
- Conforms to EN 60947-5-5.
- Includes a safety lock to prevent misuse.
- Features separate construction that allows the Switch to be separated for easier wiring and one-piece construction that allows easier handling.
- Models available with 3 contacts built into a single block (A165E-U).





For the most recent information on models that have been certified for safety standards, refer to your OMRON website.

**!** Be sure to read the "Safety Precautions" on page 9.

## Model Number Structure

### List of Models

| Diameter of Operation Unit   | Function              | Model       | Shape  |
|------------------------------|-----------------------|-------------|--|
| 30-mm models<br>40-mm models | Push-Lock, turn-reset | A165E       | <br>(30-mm model) |
|                              |                       | A165E-□-03U | <br>(30-mm model) |

### Model Number Legend (Completely Assembled)

Shipped as a set that includes the Operation Unit and light source.

**A165E-LS-24D-02-□**

IP65 (Oil-resistant)

#### 1. Operation Unit Shape and Functions

| Code | Functions   | Pushbutton |
|------|-------------|------------|
| S    | Non-lighted | 30 dia.    |
| LS   | Lighted     |            |
| M    | Non-lighted | 40 dia.    |
| LM   | Lighted     |            |

#### 2. Light Source

| Code | Type        | Operation voltage | Rated voltage  |
|------|-------------|-------------------|----------------|
| None | Non-lighted | ---               | ---            |
| 24D  | LED         | 24 VAC/<br>VDC±5% | 24 VAC/<br>VDC |

#### 3. Contacts

| Code | Description |
|------|-------------|
| 01   | 1NC(1)      |
| 02   | 2NC(2)      |
| 03U  | 3NC(3) *    |

\* 3NC(3) models have one-piece construction with the contact unit. Only non-lighted models are available.

#### 4.

| Code | Description                                     |
|------|---|
| None | Arrows and text printed in white on Pushbutton. |
| PK   | Arrows and text printed in pink on Pushbutton.  |

**Note:** Models with separate construction (1NC(1) and 2NC(2)) are for normal loads only. One-piece models (3NC(3)) are for either normal loads or microloads.

## Ordering Information

### List of Sets

| Illumination | Rated voltage      | Pushbutton color | Pushbutton size | Terminal        | Contact form | Model              |
|--------------|--------------------|------------------|-----------------|-----------------|--------------|--------------------|
| LED          | 24 VAC/VDC         | Red              | 30 dia.         | Solder terminal | 1NC(1)       | A165E-LS-24D-01    |
|              |                    |                  |                 |                 |              | A165E-LS-24D-01-PK |
| 2NC(2)       | A165E-LS-24D-02    |                  |                 |                 |              |                    |
|              | A165E-LS-24D-02-PK |                  |                 |                 |              |                    |
| Non-lighted  | ---                |                  |                 |                 | 1NC(1)       | A165E-S-01         |
|              |                    |                  |                 |                 |              | A165E-S-01-PK      |
| 2NC(2)       | A165E-S-02         |                  |                 |                 |              |                    |
|              | A165E-S-02-PK      |                  |                 |                 |              |                    |
| LED          | 24 VAC/VDC         |                  | 40 dia.         |                 | 1NC(1)       | A165E-LM-24D-01    |
|              |                    |                  |                 |                 |              | A165E-LM-24D-01-PK |
| 2NC(2)       | A165E-LM-24D-02    |                  |                 |                 |              |                    |
|              | A165E-LM-24D-02-PK |                  |                 |                 |              |                    |
| Non-lighted  | ---                | 1NC(1)           |                 | A165E-M-01      |              |                    |
|              |                    |                  |                 | A165E-M-01-PK   |              |                    |
| 2NC(2)       | A165E-M-02         |                  |                 |                 |              |                    |
|              | A165E-M-02-PK      |                  |                 |                 |              |                    |
| Non-lighted  | ---                | 30 dia.          | 3NC(3)          | A165E-S-03U     |              |                    |
|              |                    |                  |                 | A165E-S-03U-PK  |              |                    |
|              |                    | 40 dia.          |                 | A165E-M-03U     |              |                    |
|              |                    |                  |                 | A165E-M-03U-PK  |              |                    |

### List of Sets (in Different Colors)

| Illumination | Pushbutton color * | Pushbutton size | Terminal        | Contact form | Model         |
|--------------|--------------------|-----------------|-----------------|--------------|---------------|
| Non-lighted  | Yellow             | 30 dia.         | Solder terminal | 1NC(1)       | A165E-SY-01   |
|              | Gray               |                 |                 |              | A165E-SGR-01  |
|              | Yellow             |                 |                 | 2NC(2)       | A165E-SY-02   |
|              | Gray               |                 |                 |              | A165E-SGR-02  |
|              | Yellow             |                 |                 | 3NC(3)       | A165E-SY-03U  |
|              | Gray               |                 |                 |              | A165E-SGR-03U |

\* Models with yellow or gray pushbutton colors cannot be used as emergency switches.

### Individual Parts (for Switches with Separate Construction)

#### Operation Units

| Appearance  | Illumination | Model       |
|---|--------------|-------------|
| 30 dia.  | Non-lighted  | A165E-S     |
|   |              | A165E-S-PK  |
|   | Lighted      | A165E-LS    |
|   |              | A165E-LS-PK |
| 40 dia.  | Non-lighted  | A165E-M     |
|   |              | A165E-M-PK  |
|   | Lighted      | A165E-LM    |
|   |              | A165E-LM-PK |

#### Lamps

| Appearance  | LED color |        | Rated voltage | Model     |
|---|-----------|--------|---------------|-----------|
|  | Red       | Bright | 5 VDC         | A16-5DSR  |
|   |           |        | 12 VAC/VDC    | A16-12DSR |
|   |           |        | 24 VAC/VDC    | A16-24DSR |





#### Switches

| Appearance  | Illumination | Contact form | Model     |
|---|--------------|--------------|-----------|
|  | Non-lighted  | 1NC(1)       | A165E-01  |
|   |              | 2NC(2)       | A165E-02  |
|   | Lighted      | 1NC(1)       | A165E-01L |
|   |              | 2NC(2)       | A165E-02L |

#### Switch Units

| Appearance  | Illumination | Contact form | Model          |
|---|--------------|--------------|----------------|
|  | Lighted      | 1NC(1)       | A165E-R-24D-01 |
|   |              | 2NC(2)       | A165E-R-24D-02 |

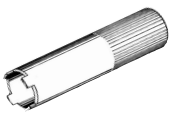
## Accessories (Order Separately)

| Item            | Appearance  | Type            | Model      | Precautions   |
|-----------------|---|-----------------|------------|---|
| Yellow Plate    |  | Yellow, 45 dia. | A16Z-5070  | Use this as an emergency stop nameplate.  |
| Panel Plug      |  | Round           | A16ZT-3003 | Used for covering the panel cutouts for future panel expansion.<br>Degree of protection: IP40<br>Color: Black |
| Tightening Tool |  | ---             | A16Z-3004  | Useful for repetitive mounting. Be careful not to tighten excessively.  |
| Extractor       |  |                 | A16Z-5080  | Convenient for extracting the Switch and Lamp.  |

## Specifications

### Certified Standard Ratings

UL508, CSA C22.2 No.14, CCC(GB14048.5)

Models with Separate Construction

| Rated voltage | Resistive load |
|---------------|----------------|
| 125 VAC       | 5 A            |
| 250 VAC       | 3 A            |
| 30 VDC        | 3 A            |

Models with One-piece Construction

| Rated voltage | Resistive load |
|---------------|----------------|
| 125 VAC       | 1 A            |
| 250 VAC       | 0.5 A          |
| 30 VDC        | 1 A            |

### TÜV(EN60947-5-1)

Models with Separate Construction

| Rated voltage | Resistive load |
|---------------|----------------|
| 250 VAC       | 3 A            |
| 30 VDC        | 3 A            |

Models with One-piece Construction

| Rated voltage | Resistive load |
|---------------|----------------|
| 250 VAC       | 0.5 A          |
| 30 VDC        | 1 A            |

### Certified Standards

| Certification body | Standards   | File No.                                       |
|--------------------|---|--|
| UL *               | UL508, CSA C22.2 No.14                              | E76675   |
| TÜV SÜD            | EN60947-5-1 (certified direct opening), EN60947-5-5 | Consult your OMRON representative for details. |
| CQC (CCC)          | GB14048.5   | 2003010303070678                               |

\* Certification for CSA C22.2 No. 14 has been obtained. Separate construction models have been certified for the Switch Unit.

### Switch Ratings

Models with Separate Construction

| Rated voltage | Resistive load |
|---------------|----------------|
| 125 VAC       | 5 A            |
| 250 VAC       | 3 A            |
| 30 VDC        | 3 A            |

**Note:** Minimum applicable load: 5 VDC, 150 mA

Models with One-piece Construction

| Rated voltage | Resistive load |
|---------------|----------------|
| 125 VAC       | 1 A            |
| 250 VAC       | 0.5 A          |
| 30 VDC        | 1 A            |

**Note:** Minimum applicable load: 5 VDC, 1 mA

### LED Ratings

(Only for Models with LEDs)

| Rated voltage | Rated current | Operation voltage |
|---------------|---------------|-------------------|
| 24 VAC/VDC    | 8 mA          | 24 VAC/VDC±5%     |

## Characteristics

| Item                            | Type                                    | Emergency Stop Switch  |   |   |
|---------------------------------|---|--|---|---|
|                                 |   | Non-lighted<br>A165E-S/A165E-M                                 | Lighted<br>A165E-LS/A165-LM                         | Non-lighted,<br>One-piece construction<br>A165E-U |
| Allowable operating frequency   | Mechanical                              | 20 operations/minute max.                                      |   |   |
|                                 | Electrical                              | 10 operations/minute max.                                      |   |   |
| Insulation resistance           |   | 100 MΩ min. (at 500 VDC)                                       |   |   |
| Dielectric strength             | Between terminals of same polarity      | 1,000 VAC, 50/60 Hz for 1 min                                  |   |   |
|                                 | Between terminals of different polarity | 2,000 VAC 50/60 Hz for 1 min                                   |   |   |
|                                 | Between each terminal and ground        | 2,000 VAC 50/60 Hz for 1 min                                   |   |   |
|                                 | Between lamp terminals                  | 1,000 VAC, 50/60 Hz for 1 min *1                               | ---   |   |
| Vibration resistance            | Malfunction                             | 10 to 55 Hz, 1.5-mm double amplitude (malfunction within 1 ms) |   |   |
| Shock resistance                | Destruction                             | 500 m/s <sup>2</sup>   |   |   |
|                                 | Malfunction                             | 300 m/s <sup>2</sup> max. (malfunction within 1 ms)            | 150 m/s <sup>2</sup> max. (malfunction within 1 ms) |   |
| Durability                      | Mechanical                              | 100,000 operations min.  |   |   |
|                                 | Electrical                              | 100,000 operations min.  |   |   |
| Degree of protection            |   | IP65 Oil-resistant *2  | IP65 *2   | IP65 Oil-resistant *2                             |
| Electric shock protection class |   | Class II   |   |   |
| PTI (tracking characteristic)   |   | 175  |   |   |
| Degree of contamination         |   | 3 (EN60947-5-1)  |   |   |
| Weight                          |   | Approx. 16 g (in case of 2NC(2) Switches)                      |   |   |
| Ambient operating temperature   |   | -10 to 55°C (with no icing or condensation)                    |   |   |
| Ambient operating humidity      |   | 35% to 85%   |   |   |
| Ambient storage temperature     |   | -25 to 65°C (with no icing or condensation)                    |   |   |

\*1. LED not mounted. (Test them with the LED removed.)

\*2. Degree of protection from the front of the panel.

## Operating Characteristics

| Item             | Type    | Characteristics of models with separate construction | Characteristics of models with one-piece construction |
|------------------|---------|--|---|
| Operating force  | OF max. | 14.7 N   | 14.7 N  |
| Releasing torque | RF max. | 0.1 N·m  | 0.1 N·m   |
| Pretravel        | PT      | 3.5±0.5 mm   | 3±0.5 mm  |

## Structure and Nomenclature

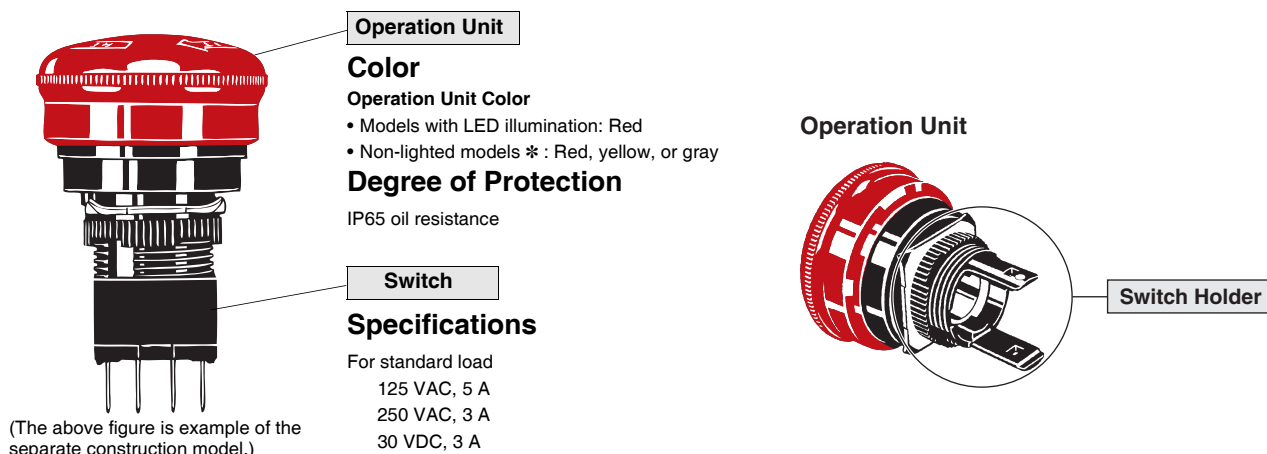

\* Models with yellow or gray pushbutton colors cannot be used as emergency switches.

# Dimensions

## A165E-S

Non-lighted models  
30 mm diameter



- When applying a coating such as paint to the panel, dimensions after the coating must satisfy the specified dimensions.
- Recommended panel thickness: 0.5 to 3.2 mm.

## A165E-LS

Lighted models  
30 mm diameter



- When applying a coating such as paint to the panel, dimensions after the coating must satisfy the specified dimensions.
- Recommended panel thickness: 0.5 to 3.2 mm.

## A165E-S-03U

Non-lighted,  
One-piece construction models  
30 mm diameter

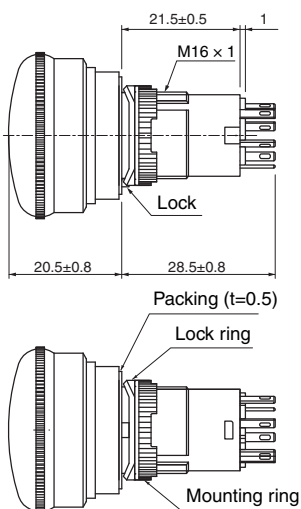
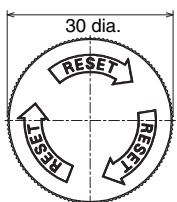

- When applying a coating such as paint to the panel, dimensions after the coating must satisfy the specified dimensions.
- Recommended panel thickness: 0.5 to 3.2 mm.

**A165E-M**

Non-lighted models  
40 mm diameter

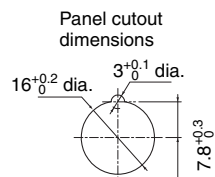
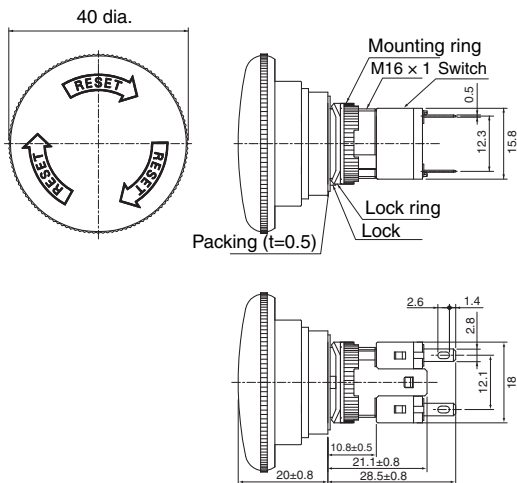
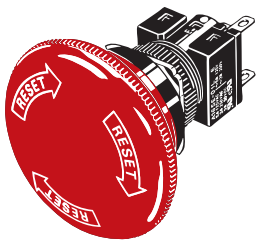

- When applying a coating such as paint to the panel, dimensions after the coating must satisfy the specified dimensions.
- Recommended panel thickness: 0.5 to 3.2 mm.

**A165E-LM**

Lighted models  
40 mm diameter

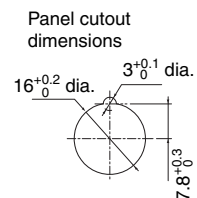
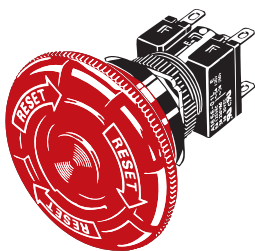

- When applying a coating such as paint to the panel, dimensions after the coating must satisfy the specified dimensions.
- Recommended panel thickness: 0.5 to 3.2 mm.

**A165E-M-03U**

One-piece construction models  
40 mm diameter

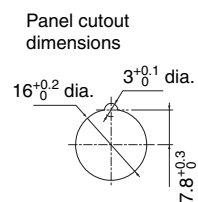
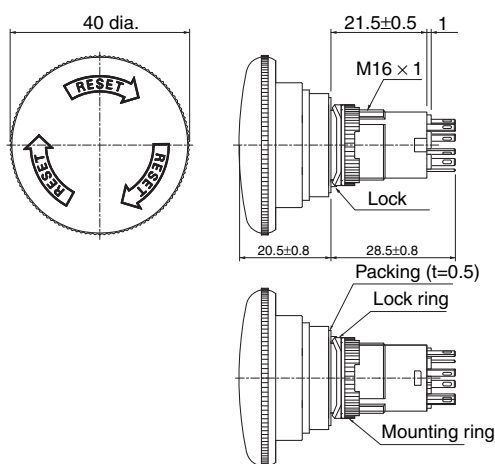
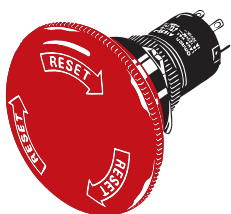

- When applying a coating such as paint to the panel, dimensions after the coating must satisfy the specified dimensions.
- Recommended panel thickness: 0.5 to 3.2 mm.

## Accessories

### Yellow Plate (Vinyl Chloride)

A16Z-5070



### Lock Ring



### Panel Plugs (Round Type)

A16ZT-3003



- Select an appropriate Panel Plug according to the panel design and mount from the front side of the panel. Panel cutout dimensions are the same as those for the Operation Unit.

### Tightening Tool

A16Z-3004

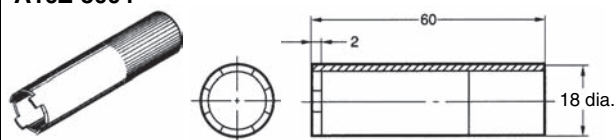

## Terminal Arrangement

| 1NC(1) | 2NC(2) | 3NC(3) |
|--------|--------|--------|
|        |        |        |

**Note:** The L+ and L- terminals are not available with the non-lighted models.

# Installation

## Mounting to the Panel (Models with Separate Construction)

After installing the Operation Unit, snap in the Switch from the back of the panel.

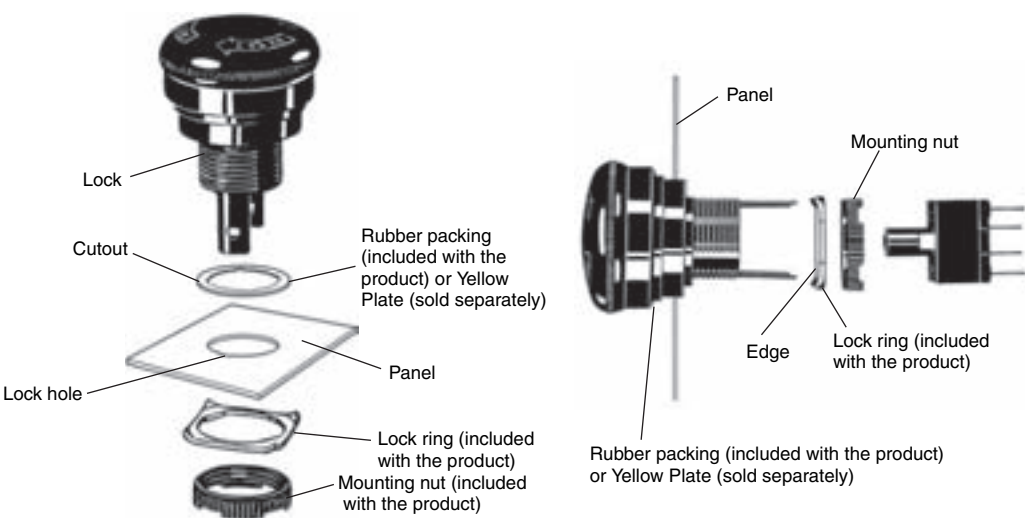
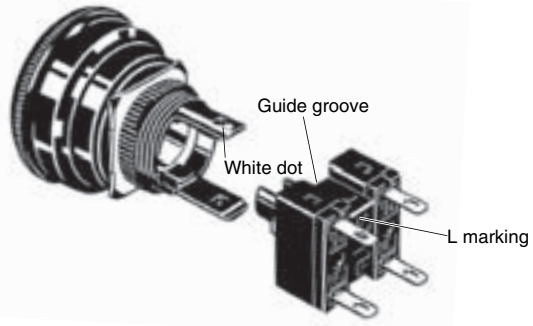
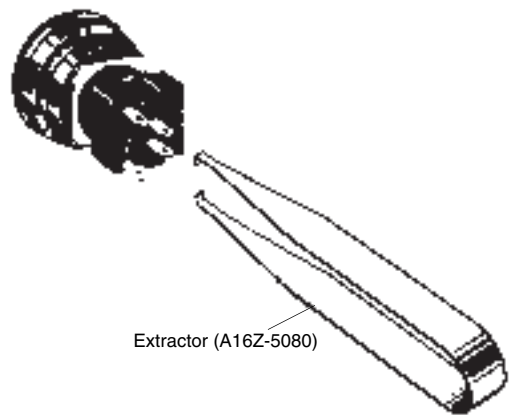
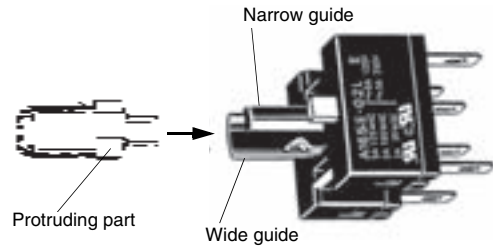
| (1) Installing the Operation Unit   |  |
|---|--|
| <ul style="list-style-type: none"> <li>• Attach rubber packing or the Yellow Plate onto the Operation Unit from its terminal side. Insert the Operation Unit into the panel from the front. Install the lock ring and mounting nut from the terminal side and tighten.</li> <li>• Adjust the slits on the hole of rubber packing and Yellow Plate to the protruding part of the Unit.</li> <li>• Rubber packing is not necessary when the Yellow Plate is used.</li> <li>• Tighten the nut to the torque of 0.29 to 0.49 N·m.</li> <li>• The Operation Unit should be installed with its protruding part adjusted to the slit of the panel hole.</li> <li>• Align the lock ring to the groove of the Operation Unit so that the edge is drawn to the panel side.</li> </ul> |    |
| (2) Mounting the Switch   | (3) Removing the Switch  |
| <ul style="list-style-type: none"> <li>• Snap on the Switch to the Operation Unit.</li> <li>• Make sure that the Switch has the correct orientation when snapping it onto the Operation Unit.</li> <li>• Align the white dot on the Operation Unit with the guide groove on the side of the Switch marked with an "L" as shown below, and push the Switch into the Operation Unit until it clicks into place. Confirm that the Switch is securely in place before using.</li> </ul>    | <ul style="list-style-type: none"> <li>• Insert the prongs of the A16Z-5080 Extractor between the Switch and the Operation Unit, grip the Switch, and pull to remove.</li> </ul>  |
| (4) Installing the LED Lamp   |  |
| <ul style="list-style-type: none"> <li>• When mounting the Lamp, make sure it is facing the direction shown in the following diagram. Insert the Lamp while matching the protruding part of the Lamp and the small guides on the outer surface of the switch.</li> </ul>   |  |



## Safety Precautions

Be sure to read the precautions for all A165E models in the website at: <http://www.ia.omron.com/>.

### Indication and Meaning for Safe Use

|                                 |   |
|---------------------------------|---|
| <b>⚠ CAUTION</b>                | <b>Indicates a potentially hazardous situation which, if not avoided, may result in minor or moderate injury or in property damage.</b> |
| <b>Precautions for Safe Use</b> | <b>Supplementary comments on what to do or avoid doing, to use the product safely.</b>  |

### ⚠ CAUTION

If the Operation Unit is separated from the Switch Unit, the equipment will not stop, creating a hazardous condition. Always confirm that safety functions are operating before starting operation.



### Precautions for Correct Use

#### Mounting

- Always make sure that the power is turned OFF before mounting, removing, or wiring the Switch, or performing maintenance. Electrical shock or fire may result if the power is not turned OFF.
- The tightening torque is 0.29 to 0.49 N·m.

#### Wiring

- Be sure to use electrical wires that are a size appropriate for the applied voltage and carry current. Perform soldering according to the conditions given below. If the soldering is not properly performed, abnormal heating may result, possibly resulting in fire.
  1. Hand soldering: 30 W, within 5 s
  2. Dip soldering: 240°C, within 3 s
 Wait for one minute after soldering before exerting any external force on the solder.
- Use non-corrosive resin fluid as the flux.
- Make sure that the electric cord is wired so that it does not touch the Unit. If the electric cord will touch the Unit, then electric wires with a heat resistance of 100°C min. must be used.
- After wiring the Switch, maintain an appropriate clearance and creepage distance.

#### Operating Environment

- The IP65 model is designed with a degree of protection so that it will not sustain damage if it is subjected to water from any direction to the front of the panel.
- The Switch is intended for indoor use only. Using the Switch outdoor may cause it to fail.

### Using the Microload

- Insert a contact protection circuit, if necessary, to prevent the reduction of life expectancy due to extreme wear on the contacts caused by loads where inrush current occurs when the contact is opened and closed.
- The A165E-□U (one-piece construction) allows both a standard load (125 V at 1 A, 250 V at 0.5 A) and a microload. If a standard load is applied, however, the microload area cannot be used. If the microload area is used with a standard load, the contact surface will become rough, and the opening and closing of the contact for a microload may become unreliable.
- The minimum applicable load is the N-level reference value. This value indicates the malfunction reference level for the reliability level of 60% ( $\lambda_{60}$ ) (conforming to JIS C5003).
- The equation,  $\lambda_{60} = 0.5 \times 10^{-6}/\text{time}$  indicates that the estimated malfunction rate is less than 1/2,000,000 with a reliability level of 60%.

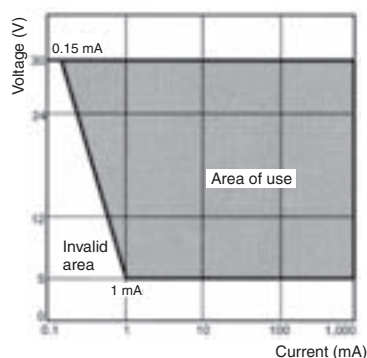

### LEDs

The LED current-limiting resistor is built-in, so external resistance is not required.

| Rated voltage | Internal limiting resistor |
|---------------|----------------------------|
| 24 VAC/VDC    | 2.4 kΩ                     |

### Operating Torque

- Do not exceed an operating torque of 0.49 N·m in the direction of rotation.
- Do not pull the operating button or apply excessive force to any side of the button. Otherwise it may be damaged.

## Others

- The oil-resistant IP65 uses NBR rubber and is resistant to general cutting oil and cooling oil. Some special oils cannot be used with the oil-resistant IP65, however, so contact your OMRON representative for details.
- If the panel is to be coated, make sure that the panel meets the specified dimensions after coating.
- Due to the structure of the Switch, severe shock or vibration may cause malfunctions or damage to the Switch.  
Also, most Switches are made from resin and will be damaged if they come into contact with sharp objects. Particularly scratches on the Operation Unit may create visual and operational obtrusions. Handle the Switches with care, and do not throw or drop them.

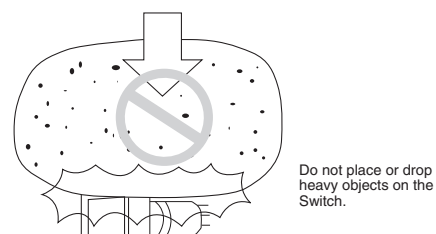

## Terms and Conditions Agreement

### Read and understand this catalog.

Please read and understand this catalog before purchasing the products. Please consult your OMRON representative if you have any questions or comments.

### Warranties.

(a) Exclusive Warranty. Omron's exclusive warranty is that the Products will be free from defects in materials and workmanship for a period of twelve months from the date of sale by Omron (or such other period expressed in writing by Omron). Omron disclaims all other warranties, express or implied.

(b) Limitations. OMRON MAKES NO WARRANTY OR REPRESENTATION, EXPRESS OR IMPLIED, ABOUT NON-INFRINGEMENT, MERCHANTABILITY OR FITNESS FOR A PARTICULAR PURPOSE OF THE PRODUCTS. BUYER ACKNOWLEDGES THAT IT ALONE HAS DETERMINED THAT THE PRODUCTS WILL SUITABLY MEET THE REQUIREMENTS OF THEIR INTENDED USE.

Omron further disclaims all warranties and responsibility of any type for claims or expenses based on infringement by the Products or otherwise of any intellectual property right. (c) Buyer Remedy. Omron's sole obligation hereunder shall be, at Omron's election, to (i) replace (in the form originally shipped with Buyer responsible for labor charges for removal or replacement thereof) the non-complying Product, (ii) repair the non-complying Product, or (iii) repay or credit Buyer an amount equal to the purchase price of the non-complying Product; provided that in no event shall Omron be responsible for warranty, repair, indemnity or any other claims or expenses regarding the Products unless Omron's analysis confirms that the Products were properly handled, stored, installed and maintained and not subject to contamination, abuse, misuse or inappropriate modification. Return of any Products by Buyer must be approved in writing by Omron before shipment. Omron Companies shall not be liable for the suitability or unsuitability or the results from the use of Products in combination with any electrical or electronic components, circuits, system assemblies or any other materials or substances or environments. Any advice, recommendations or information given orally or in writing, are not to be construed as an amendment or addition to the above warranty.

See <http://www.omron.com/global/> or contact your Omron representative for published information.

### Limitation on Liability; Etc.

OMRON COMPANIES SHALL NOT BE LIABLE FOR SPECIAL, INDIRECT, INCIDENTAL, OR CONSEQUENTIAL DAMAGES, LOSS OF PROFITS OR PRODUCTION OR COMMERCIAL LOSS IN ANY WAY CONNECTED WITH THE PRODUCTS, WHETHER SUCH CLAIM IS BASED IN CONTRACT, WARRANTY, NEGLIGENCE OR STRICT LIABILITY.

Further, in no event shall liability of Omron Companies exceed the individual price of the Product on which liability is asserted.

### Suitability of Use.

Omron Companies shall not be responsible for conformity with any standards, codes or regulations which apply to the combination of the Product in the Buyer's application or use of the Product. At Buyer's request, Omron will provide applicable third party certification documents identifying ratings and limitations of use which apply to the Product. This information by itself is not sufficient for a complete determination of the suitability of the Product in combination with the end product, machine, system, or other application or use. Buyer shall be solely responsible for determining appropriateness of the particular Product with respect to Buyer's application, product or system. Buyer shall take application responsibility in all cases.

NEVER USE THE PRODUCT FOR AN APPLICATION INVOLVING SERIOUS RISK TO LIFE OR PROPERTY OR IN LARGE QUANTITIES WITHOUT ENSURING THAT THE SYSTEM AS A WHOLE HAS BEEN DESIGNED TO ADDRESS THE RISKS, AND THAT THE OMRON PRODUCT(S) IS PROPERLY RATED AND INSTALLED FOR THE INTENDED USE WITHIN THE OVERALL EQUIPMENT OR SYSTEM.

### Programmable Products.

Omron Companies shall not be responsible for the user's programming of a programmable Product, or any consequence thereof.

### Performance Data.

Data presented in Omron Company websites, catalogs and other materials is provided as a guide for the user in determining suitability and does not constitute a warranty. It may represent the result of Omron's test conditions, and the user must correlate it to actual application requirements. Actual performance is subject to the Omron's Warranty and Limitations of Liability.

### Change in Specifications.

Product specifications and accessories may be changed at any time based on improvements and other reasons. It is our practice to change part numbers when published ratings or features are changed, or when significant construction changes are made. However, some specifications of the Product may be changed without any notice. When in doubt, special part numbers may be assigned to fix or establish key specifications for your application. Please consult with your Omron's representative at any time to confirm actual specifications of purchased Product.

### Errors and Omissions.

Information presented by Omron Companies has been checked and is believed to be accurate; however, no responsibility is assumed for clerical, typographical or proofreading errors or omissions.

2017.10

In the interest of product improvement, specifications are subject to change without notice.

**OMRON Corporation**  
Industrial Automation Company

<http://www.ia.omron.com/>

(c)Copyright OMRON Corporation 2017 All Right Reserved.

# Mouser Electronics

Authorized Distributor

Click to View Pricing, Inventory, Delivery & Lifecycle Information:

## Omron:

[A165E-S-01](#) [A165E-S-02](#) [A165E-S-03U](#) [A165E-01](#) [A165E-01L](#) [A165E-02](#) [A165E-02L](#) [A165E-LM](#) [A165E-LM-24D-01](#) [A165E-LM-24D-02](#) [A165E-LS](#) [A165E-M](#) [A165E-M-02](#) [A165E-R-24D-01](#) [A165E-S](#) [A165E-S-01\(STOP\)](#) [A165E-S-02\(STOP\)](#) [A165E-SY](#) [A165E-SY-01](#) [A165E-M-03U](#) [A165E-S-03U-S](#)

Компания «Life Electronics» занимается поставками электронных компонентов импортного и отечественного производства от производителей и со складов крупных дистрибьюторов Европы, Америки и Азии.

С конца 2013 года компания активно расширяет линейку поставок компонентов по направлению коаксиальный кабель, кварцевые генераторы и конденсаторы (керамические, пленочные, электролитические), за счёт заключения дистрибьюторских договоров

Мы предлагаем:

- Конкурентоспособные цены и скидки постоянным клиентам.
- Специальные условия для постоянных клиентов.
- Подбор аналогов.
- Поставку компонентов в любых объемах, удовлетворяющих вашим потребностям.
- Приемлемые сроки поставки, возможна ускоренная поставка.
- Доставку товара в любую точку России и стран СНГ.
- Комплексную поставку.
- Работу по проектам и поставку образцов.
- Формирование склада под заказчика.
- Сертификаты соответствия на поставляемую продукцию (по желанию клиента).
- Тестирование поставляемой продукции.
- Поставку компонентов, требующих военную и космическую приемку.
- Входной контроль качества.
- Наличие сертификата ISO.

В составе нашей компании организован Конструкторский отдел, призванный помогать разработчикам, и инженерам.

Конструкторский отдел помогает осуществить:

- Регистрацию проекта у производителя компонентов.
- Техническую поддержку проекта.
- Защиту от снятия компонента с производства.
- Оценку стоимости проекта по компонентам.
- Изготовление тестовой платы монтаж и пусконаладочные работы.



Тел: +7 (812) 336 43 04 (многоканальный)

Email: [org@lifeelectronics.ru](mailto:org@lifeelectronics.ru)