

IRS2184/IRS21844(S)PbF HALF-BRIDGE DRIVER

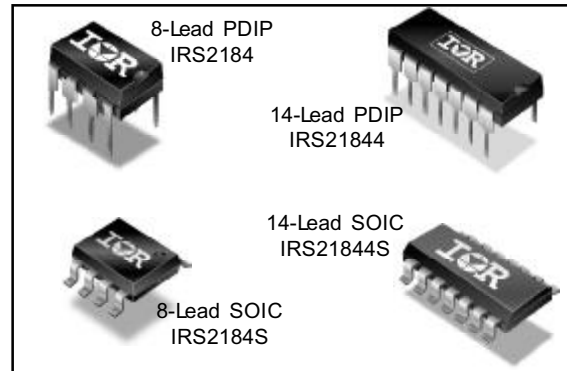
Features

- Floating channel designed for bootstrap operation
- Fully operational to +600 V
- Tolerant to negative transient voltage, dV/dt immune
- Gate drive supply range from 10 V to 20 V
- Undervoltage lockout for both channels
- 3.3 V and 5 V input logic compatible
- Matched propagation delay for both channels
- Logic and power ground +/- 5 V offset
- Lower di/dt gate driver for better noise immunity
- Output source/sink current capability 1.4 A/1.8 A
- RoHS compliant

Description

The IRS2184/IRS21844 are high voltage, high speed power MOSFET and IGBT drivers with dependent high- and low-side referenced output channels. Proprietary HVIC and latch immune CMOS technologies enable ruggedized monolithic construction. The logic input is compatible with standard CMOS or LSTTL output, down to 3.3 V logic. The output drivers feature a high pulse current buffer stage designed for minimum driver cross-conduction. The floating channel can be used to drive an N-channel power MOSFET or IGBT in the high-side configuration which operates up to 600 V.

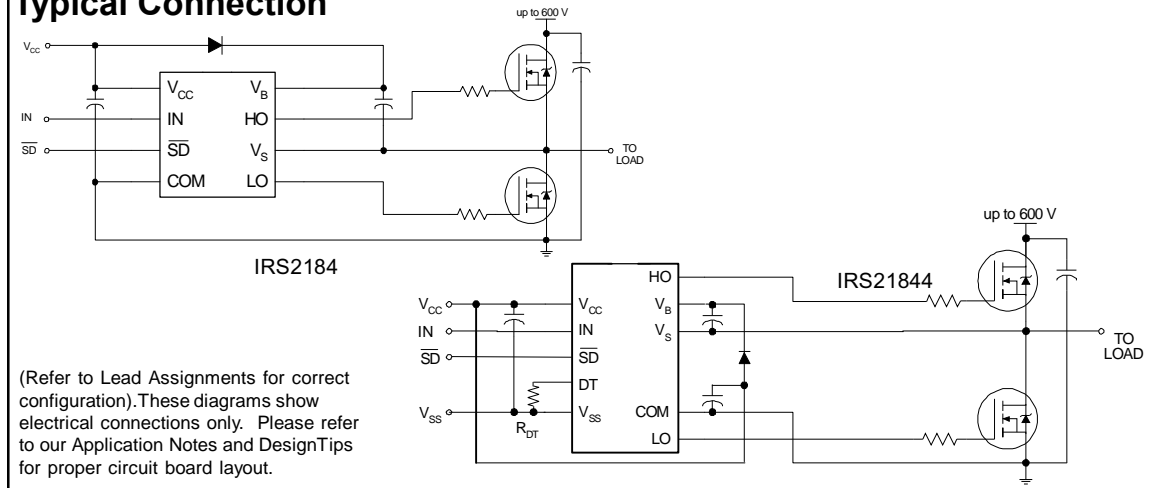
Packages



Feature Comparison

Part	Input logic	Cross-conduction prevention logic	Deadtime (ns)	Ground Pins	t_{on}/t_{off} (ns)
2181	HIN/LIN	no	none	COM	180/220
21814				V _{SS} /COM	
2183	HIN/LIN	yes	Internal 400	COM	180/220
21834				V _{SS} /COM	
2184	IN/ \overline{SD}	yes	Internal 400	COM	680/270
21844				V _{SS} /COM	

Typical Connection



Absolute Maximum Ratings

Absolute maximum ratings indicate sustained limits beyond which damage to the device may occur. All voltage parameters are absolute voltages referenced to COM. The thermal resistance and power dissipation ratings are measured under board mounted and still air conditions.

Symbol	Definition	Min.	Max.	Units	
V_B	High-side floating absolute voltage	-0.3	620 (Note 1)	V	
V_S	High-side floating supply offset voltage	$V_B - 20$	$V_B + 0.3$		
V_{HO}	High-side floating output voltage	$V_S - 0.3$	$V_B + 0.3$		
V_{CC}	Low-side and logic fixed supply voltage	-0.3	20 (Note 1)		
V_{LO}	Low-side output voltage	-0.3	$V_{CC} + 0.3$		
DT	Programmable dead-time pin voltage (IRS21844 only)	$V_{SS} - 0.3$	$V_{CC} + 0.3$		
V_{IN}	Logic input voltage (IN & \overline{SD})	$V_{SS} - 0.3$	$V_{CC} + 0.3$		
V_{SS}	Logic ground (IRS21844 only)	$V_{CC} - 20$	$V_{CC} + 0.3$		
dVs/dt	Allowable offset supply voltage transient	—	50	V/ns	
P_D	Package power dissipation @ $T_A \leq +25^\circ\text{C}$	(8-lead PDIP)	—	1.0	W
		(8-lead SOIC)	—	0.625	
		(14-lead PDIP)	—	1.6	
		(14-lead SOIC)	—	1.0	
R_{thJA}	Thermal resistance, junction to ambient	(8-lead PDIP)	—	125	$^\circ\text{C}/\text{W}$
		(8-lead SOIC)	—	200	
		(14-lead PDIP)	—	75	
		(14-lead SOIC)	—	120	
T_J	Junction temperature	—	150	$^\circ\text{C}$	
T_S	Storage temperature	-50	150		
T_L	Lead temperature (soldering, 10 seconds)	—	300		

Note 1: All supplies are fully tested at 25 V and an internal 20 V clamp exists for each supply.

Recommended Operating Conditions

The input/output logic timing diagram is shown in Fig. 1. For proper operation the device should be used within the recommended conditions. The V_S and V_{SS} offset rating are tested with all supplies biased at a 15 V differential.

Symbol	Definition	Min.	Max.	Units
V_B	High-side floating supply absolute voltage	$V_S + 10$	$V_S + 20$	V
V_S	High-side floating supply offset voltage	COM -8 (Note 2)	600	
V_{St}	Transient high-side floating supply offset voltage	-50 (Note 3)	600	
V_{HO}	High-side floating output voltage	V_S	V_B	
V_{CC}	Low-side and logic fixed supply voltage	10	20	
V_{LO}	Low-side output voltage	0	V_{CC}	
V_{IN}	Logic input voltage (IN & \overline{SD})	V_{SS}	V_{CC}	
DT	Programmable deadtime pin voltage (IRS21844 only)	V_{SS}	V_{CC}	
V_{SS}	Logic ground (IRS21844 only)	-5	5	°C
T_A	Ambient temperature	-40	125	

Note 2: Logic operational for V_S of -5 V to +600 V. Logic state held for V_S of -5 V to $-V_{BS}$. (Please refer to the Design Tip DT97-3 for more details).

Note 3: Operational for transient negative V_S of COM - 50 V with a 50 ns pulse width. Guaranteed by design. Refer to the Application Information section of this datasheet for more details.

Dynamic Electrical Characteristics

$V_{BIAS} (V_{CC}, V_{BS}) = 15\text{ V}$, $V_{SS} = \text{COM}$, $C_L = 1000\text{ pF}$, $T_A = 25^\circ\text{ C}$, DT = V_{SS} unless otherwise specified.

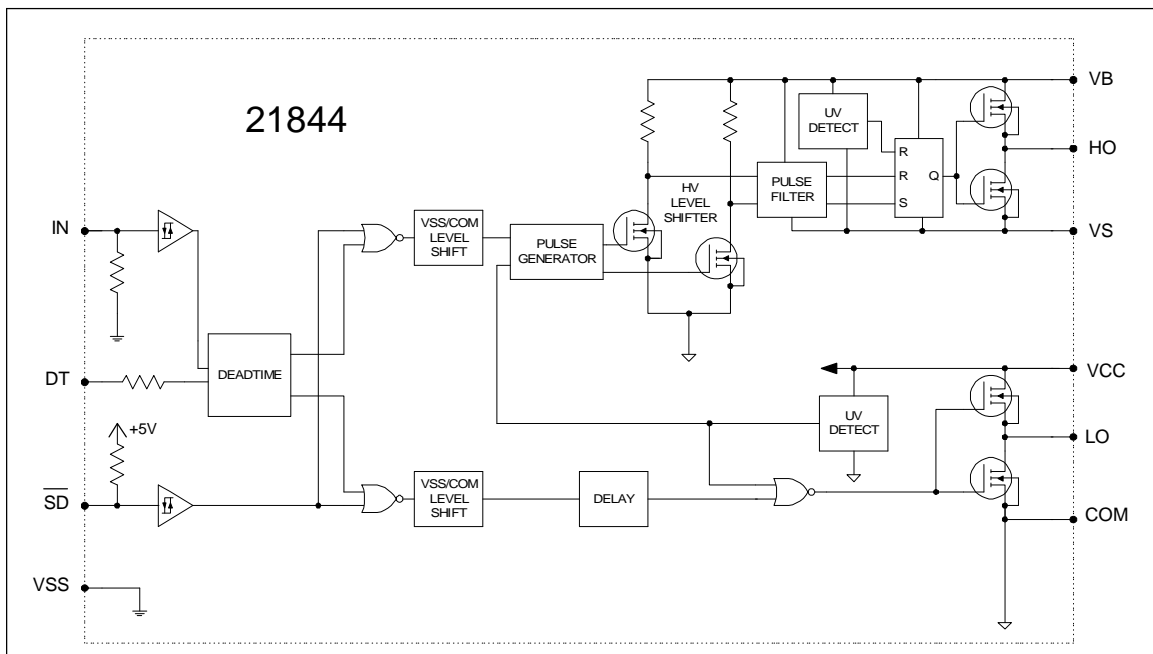
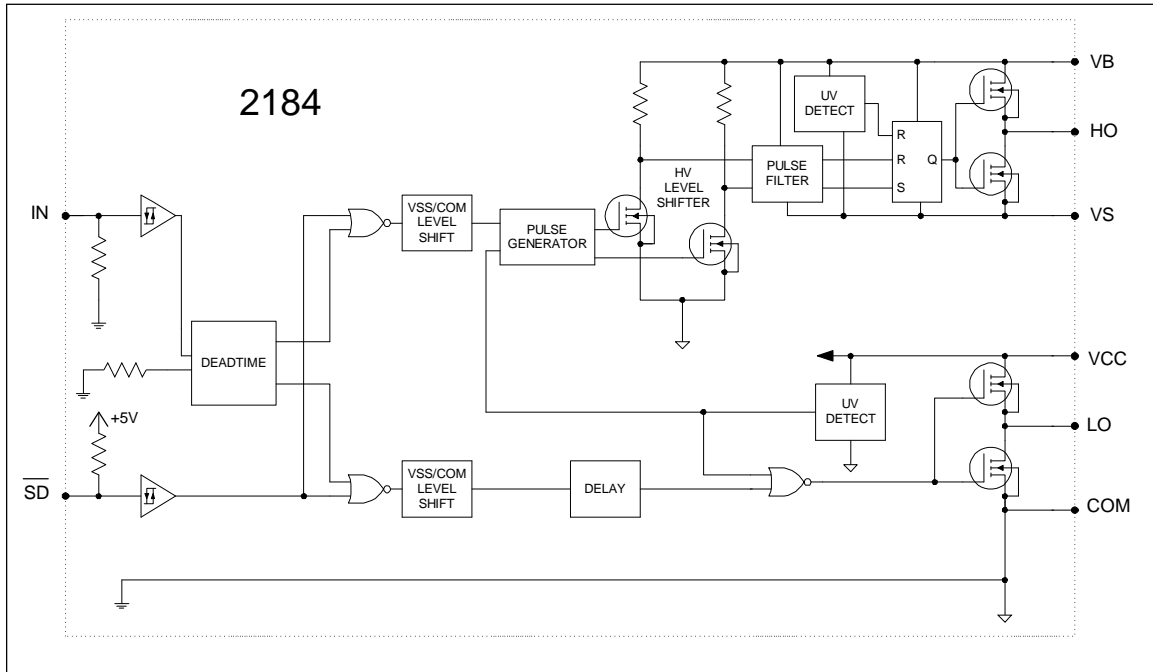
Symbol	Definition	Min.	Typ.	Max.	Units	Test Conditions
t_{on}	Turn-on propagation delay	—	680	900	ns	$V_S = 0\text{ V}$
t_{off}	Turn-off propagation delay	—	270	400		$V_S = 0\text{ V}$ or 600 V
t_{sd}	Shut-down propagation delay	—	180	270		
M T_{on}	Delay matching, HS & LS turn-on	—	0	90		
M T_{off}	Delay matching, HS & LS turn-off	—	0	40		
t_r	Turn-on rise time	—	40	60		$V_S = 0\text{ V}$
t_f	Turn-off fall time	—	20	35		
DT	Deadtime: LO turn-off to HO turn-on(DT _{LO-HO}) & HO turn-off to LO turn-on (DT _{HO-LO})	280	400	520	μs	$R_{DT} = 0\ \Omega$
		4	5	6		$R_{DT} = 200\ \text{k}\Omega$
MDT	Deadtime matching = DT _{LO} - HO - DT _{HO-LO}	—	0	50	ns	$R_{DT} = 0\ \Omega$
		—	0	600		$R_{DT} = 200\ \text{k}\Omega$

Static Electrical Characteristics

V_{BIAS} (V_{CC} , V_{BS}) = 15 V, V_{SS} = COM, $DT = V_{SS}$ and $T_A = 25$ °C unless otherwise specified. The V_{IL} , V_{IH} , and I_{IN} parameters are referenced to V_{SS} /COM and are applicable to the respective input leads: IN and \overline{SD} . The V_O , I_O , and R_{on} parameters are referenced to COM and are applicable to the respective output leads: HO and LO.

Symbol	Definition	Min.	Typ.	Max.	Units	Test Conditions	
V_{IH}	Logic "1" input voltage for HO & logic "0" for LO	2.5	—	—	V	$V_{CC} = 10$ V to 20 V	
V_{IL}	Logic "0" input voltage for HO & logic "1" for LO	—	—	0.8			
$V_{SD,TH+}$	\overline{SD} input positive going threshold	2.5	—	—			
$V_{SD,TH-}$	\overline{SD} input negative going threshold	—	—	0.8			
V_{OH}	High level output voltage, $V_{BIAS} - V_O$	—	—	1.4			$I_O = 0$ A
V_{OL}	Low level output voltage, V_O	—	—	0.2			$I_O = 20$ mA
I_{LK}	Offset supply leakage current	—	—	50	μ A	$V_B = V_S = 600$ V	
I_{QBS}	Quiescent V_{BS} supply current	20	60	150	mA	$V_{IN} = 0$ V or 5 V	
I_{QCC}	Quiescent V_{CC} supply current	0.4	1.0	1.6			
I_{IN+}	Logic "1" input bias current	—	25	60	μ A	$IN = 5$ V, $\overline{SD} = 0$ V	
I_{IN-}	Logic "0" input bias current	—	—	5.0		$IN = 0$ V, $\overline{SD} = 5$ V	
V_{CCUV+} V_{BSUV+}	V_{CC} and V_{BS} supply undervoltage positive going threshold	8.0	8.9	9.8	V		
V_{CCUV-} V_{BSUV-}	V_{CC} and V_{BS} supply undervoltage negative going threshold	7.4	8.2	9.0			
V_{CCUVH} V_{BSUVH}	Hysteresis	0.3	0.7	—			
I_{O+}	Output high short circuit pulsed current	1.4	1.9	—	A	$V_O = 0$ V, $PW \leq 10$ μ s	
I_{O-}	Output low short circuit pulsed current	1.8	2.3	—		$V_O = 15$ V, $PW \leq 10$ μ s	

Functional Block Diagrams



Lead Definitions

Symbol	Description
IN	Logic input for high-side and low-side gate driver outputs (HO and LO), in phase with HO (referenced to COM for IRS2184 and VSS for IRS21844)
\overline{SD}	Logic input for shutdown (referenced to COM for IRS2184 and VSS for IRS21844)
DT	Programmable deadtime lead, referenced to VSS. (IRS21844 only)
VSS	Logic ground (IRS21844 only)
V_B	High-side floating supply
HO	High-side gate drive output
V_S	High-side floating supply return
V_{CC}	Low-side and logic fixed supply
LO	Low-side gate drive output
COM	Low-side return

Lead Assignments

<p>8-Lead PDIP</p>	<p>8-Lead SOIC</p>
IRS2184PbF	IRS2184SPbF
<p>14-Lead PDIP</p>	<p>14-Lead SOIC</p>
IRS21844PbF	IRS21844SPbF

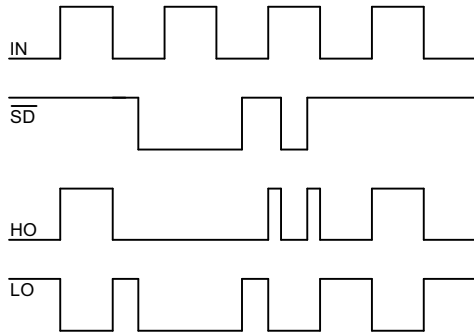


Figure 1. Input/Output Timing Diagram

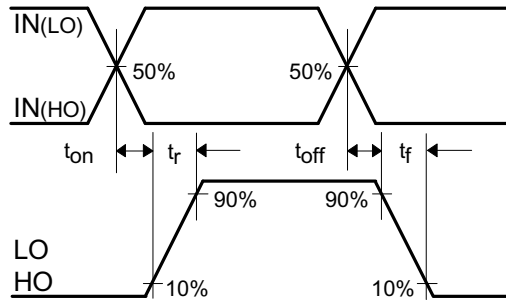


Figure 2. Switching Time Waveform Definitions

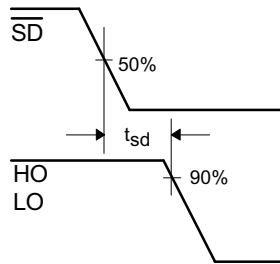


Figure 3. Shutdown Waveform Definitions

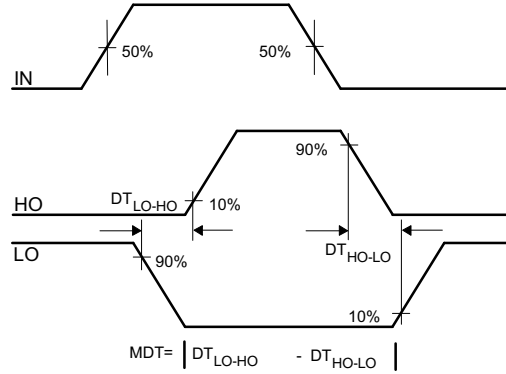


Figure 4. Deadtime Waveform Definitions

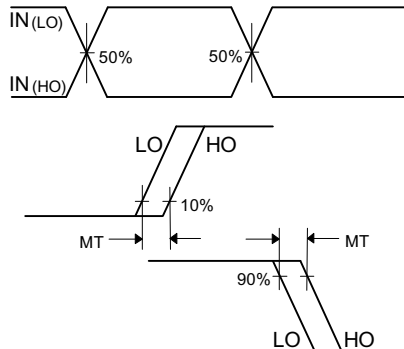


Figure 5. Delay Matching Waveform Definitions

Tolerant to Negative V_s Transients

A common problem in today's high-power switching converters is the transient response of the switch node's voltage as the power switches transition on and off quickly while carrying a large current. A typical half bridge circuit is shown in Figure 6; here we define the power switches and diodes of the inverter.

If the high-side switch (e.g., Q1 in Figures 7 and 8) switches off, while the phase current is flowing to a load, a current commutation occurs from high-side switch (Q1) to the diode (D2) in parallel with the low-side switch of the same inverter leg. At the same instance, the voltage node V_{S1} , swings from the positive DC bus voltage to the negative DC bus voltage.

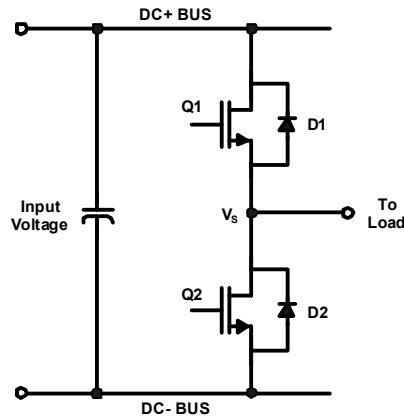


Figure 6: Half Bridge Circuit

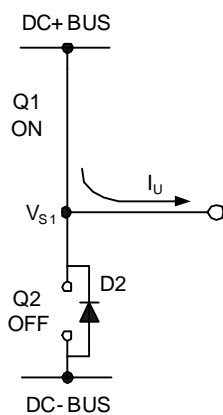


Figure 7: Q1 conducting

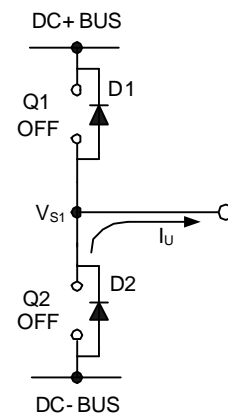


Figure 8: D2 conducting

Also when the phase current flows from the load back to the inverter (see Figures 9 and 10), and Q4 switches on, the current commutation occurs from D3 to Q4. At the same instance, the voltage node, V_{S2} , swings from the positive DC bus voltage to the negative DC bus voltage.

The circuit shown in Figure 11 depicts a half bridge circuit with parasitic elements shown; Figures 12 and 13 show a simplified illustration of the commutation of the current between Q1 and D2. The parasitic inductances in the power circuit from the die bonding to the PCB tracks are lumped together in L_C and L_E for each switch. When the high-side switch is on, V_{S1} is below the DC+ voltage by the voltage drops associated with the power switch and the parasitic elements of the circuit. When the high-side power switch turns off, the load current can momentarily flow in the low-side freewheeling diode due to the inductive load connected to V_{S1} , for instance (the load is not shown in these figures). This current flows from the DC- bus (which is connected to the COM pin of the HVIC) to the load and a negative voltage between V_{S1} and the DC- Bus is induced (i.e., the COM pin of the HVIC is at a higher potential than the V_S pin).

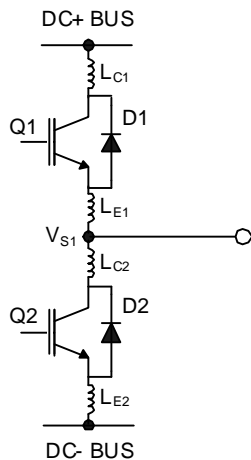


Figure 9: Parasitic Elements

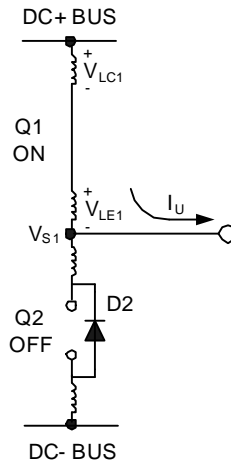


Figure 10: V_S positive

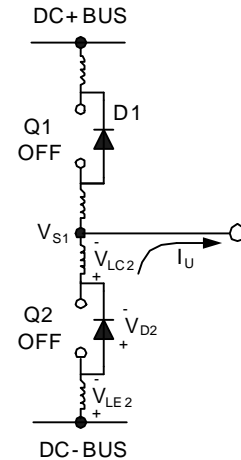


Figure 11: V_S negative

In a typical power circuit, dV/dt is typically designed to be in the range of 1-5 V/ns. The negative V_S transient voltage can exceed this range during some events such as short circuit and over-current shutdown, when di/dt is greater than in normal operation.

International Rectifier's HVICs have been designed for the robustness required in many of today's demanding applications. An indication of the IRS2184(4)'s robustness can be seen in Figure 14, where there is represented the IRS2184(4) Safe Operating Area at $V_{BS}=15V$ based on repetitive negative V_S spikes. A negative V_S transient voltage falling in the grey area (outside SOA) may lead to IC permanent damage; viceversa unwanted functional anomalies or permanent damage to the IC do not appear if negative V_S transients fall inside SOA.

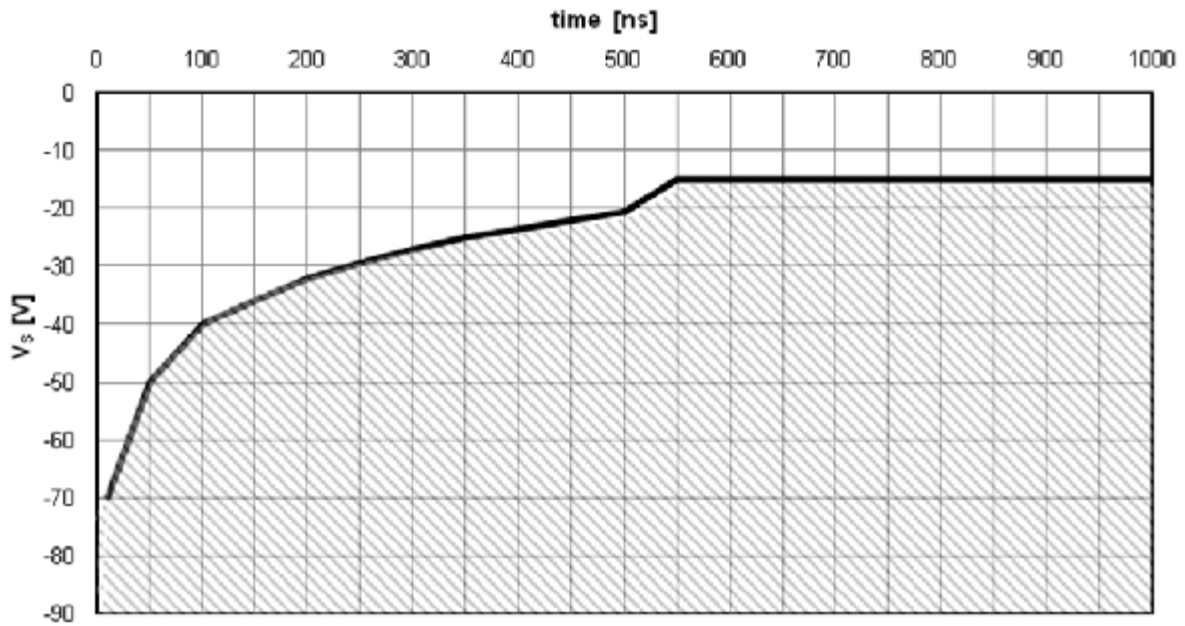


Figure 12: Negative V_s transient SOA for IRS2184 @ $V_{BS}=15V$

Even though the IRS2184(4) has been shown able to handle these large negative V_s transient conditions, it is highly recommended that the circuit designer always limit the negative V_s transients as much as possible by careful PCB layout and component use.

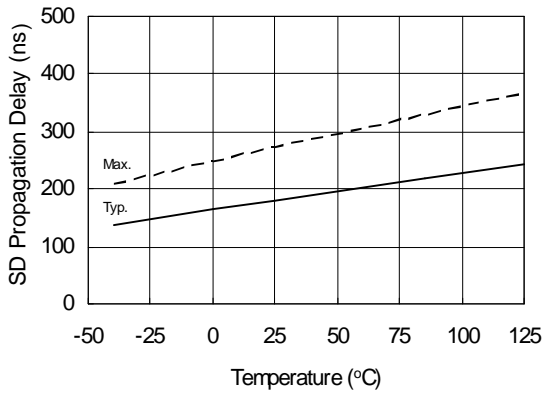


Figure 13A. Turn-On Propagation Delay Time vs. Temperature

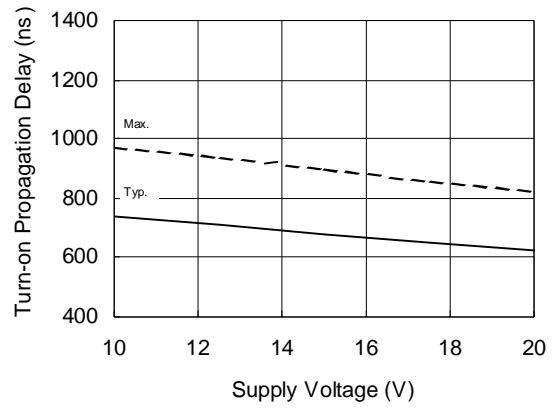


Figure 13B. Turn-On Propagation Delay Time vs. Supply Voltage

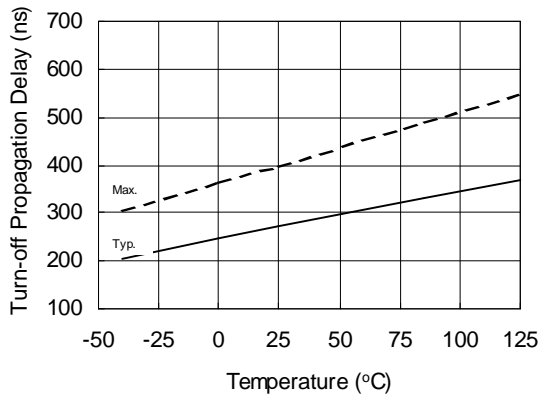


Figure 14A. Turn-Off Propagation Delay Time vs. Temperature

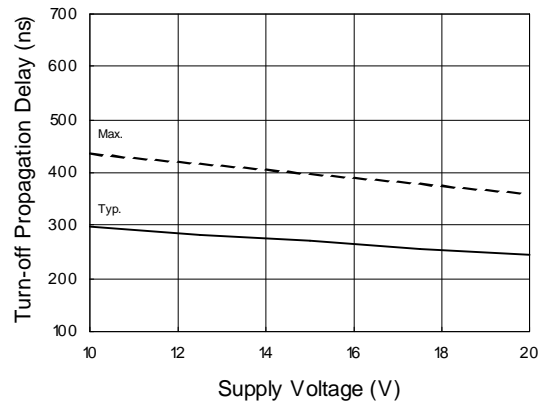


Figure 14B. Turn-Off Propagation Delay Time vs. Supply Voltage

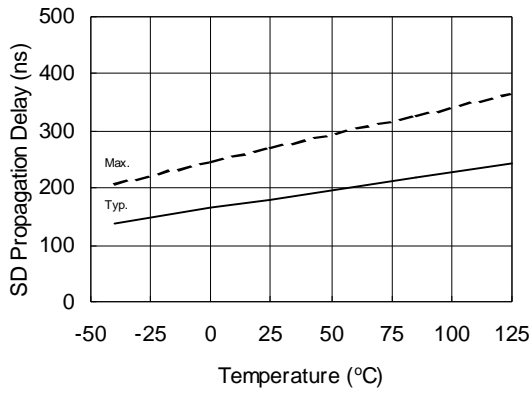


Figure 15A. SD Propagation Delay vs. Temperature

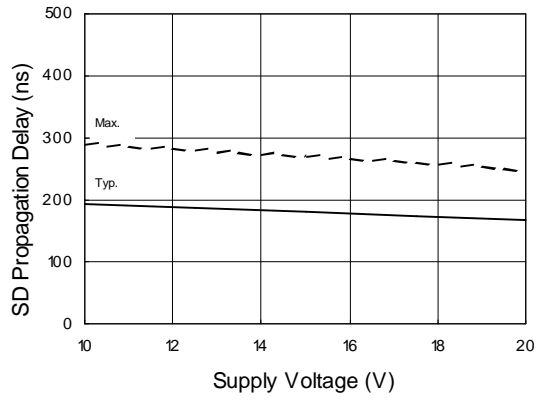


Figure 15B. SD Propagation Delay vs. Supply Voltage

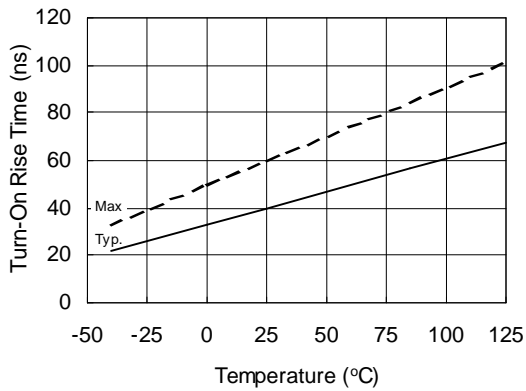


Figure 16A. Turn on Rise Time vs. Temperature

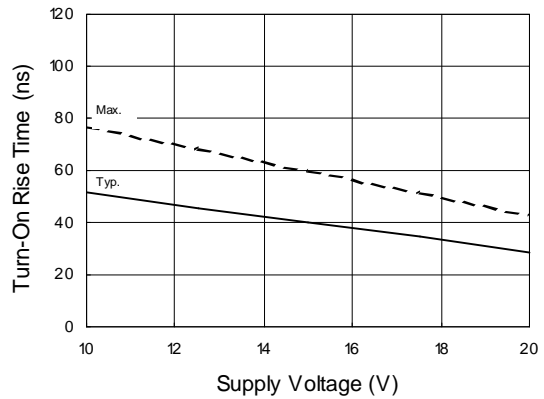


Figure 16B. Turn on Rise Time vs. Supply Voltage

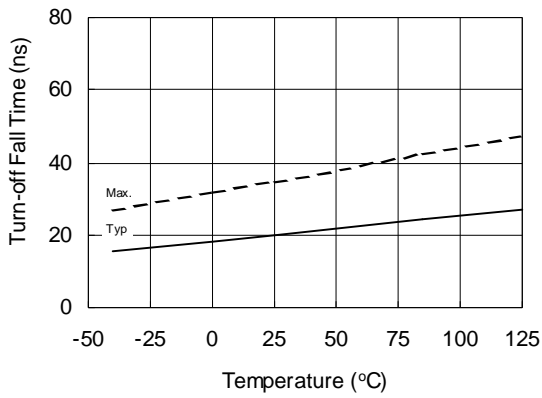


Figure 17A. Turn-Off Fall Time vs. Temperature

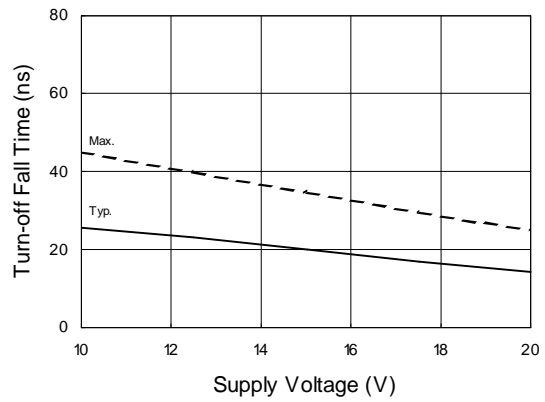


Figure 17B. Turn-Off Fall Time vs. Supply Voltage

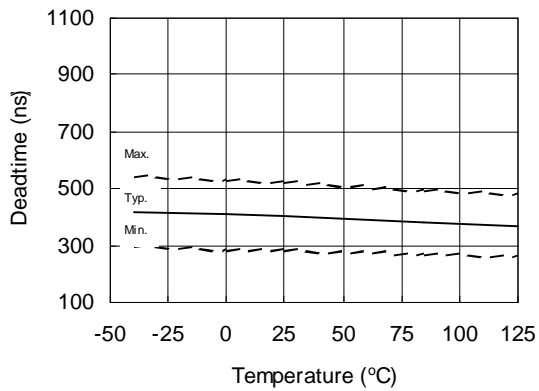


Figure 18A. Deadtime vs. Temperature

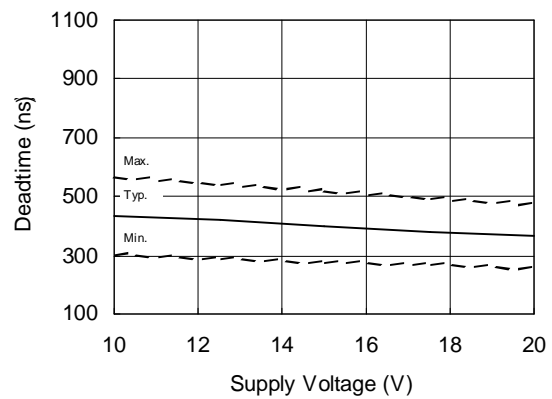


Figure 18B. Deadtime vs. Supply Voltage

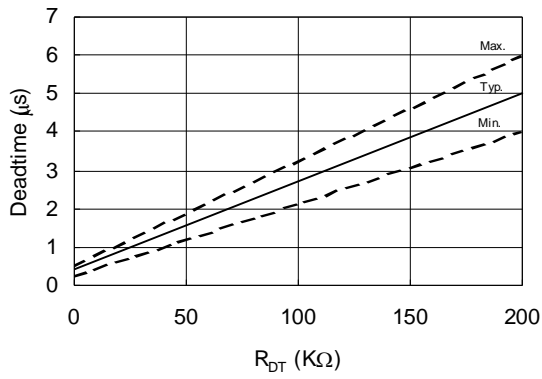


Figure 18C. Deadtime vs. R_{DT}

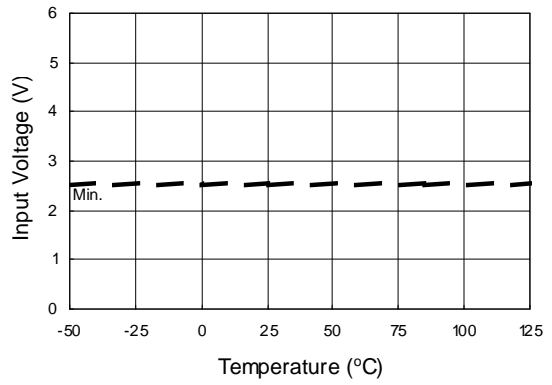


Figure 19A. Logic "1" Input Voltage vs. Temperature

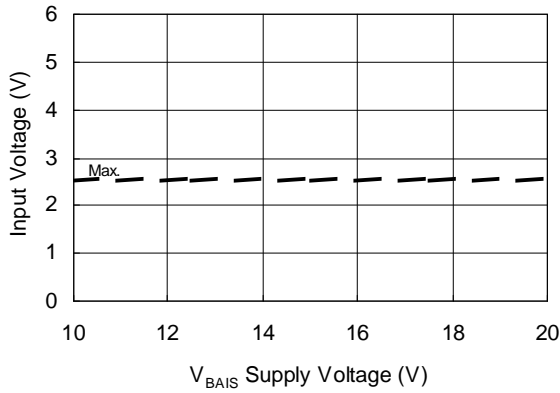


Figure 19B. Logic "1" Input Voltage vs. Supply Voltage

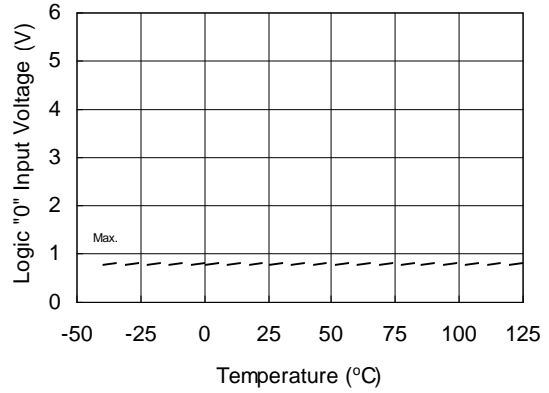


Figure 20A. Logic "0" Input Voltage vs. Temperature

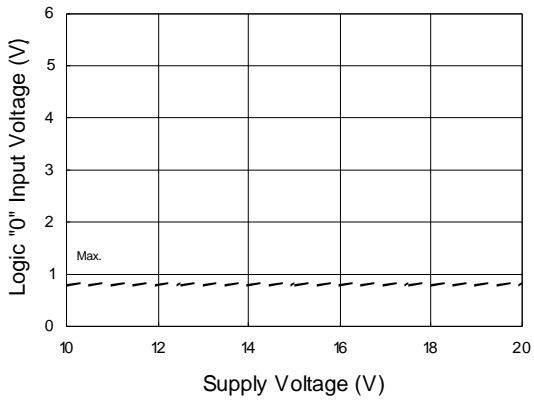


Figure 20B. Logic "0" Input Voltage vs. Supply Voltage

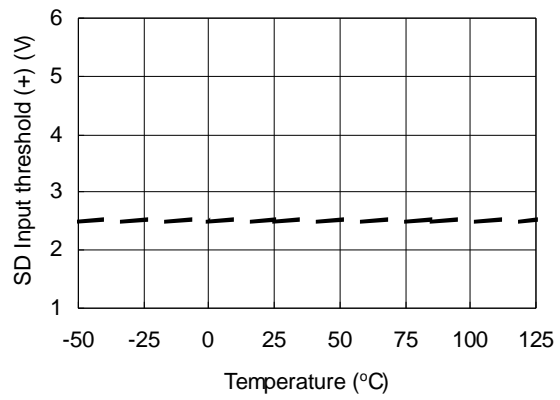


Figure 21A. SD Input Positive Going Threshold (+) vs. Temperature

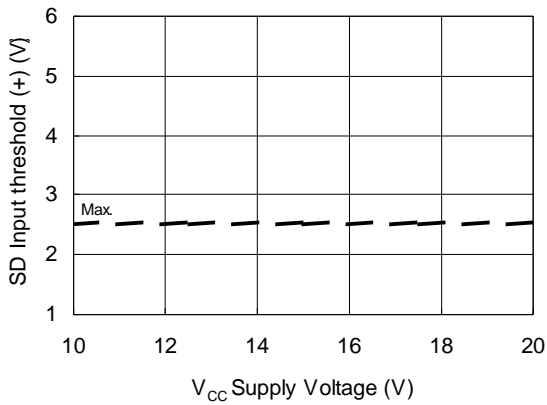


Figure 21B. SD Input Positive Going Threshold (+) vs. Supply Voltage

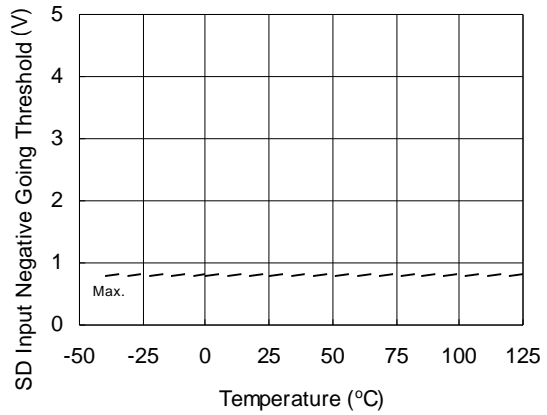


Figure 22A. SD Input Negative Going Threshold vs. Temperature

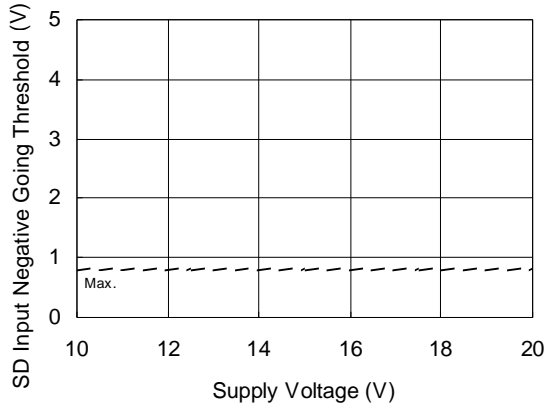


Figure 22B. SD Input Negative Going Threshold vs. Supply Voltage

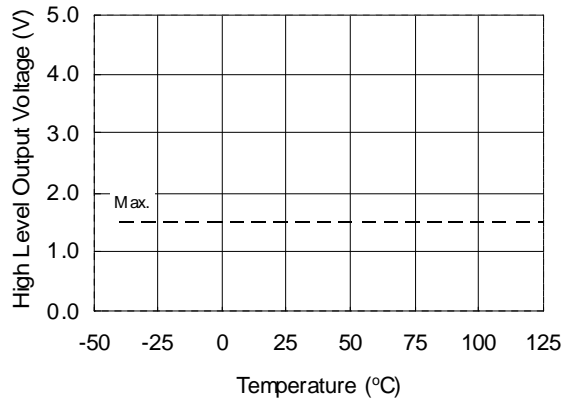


Figure 23A. High Level Output Voltage vs. Temperature (I_O = 0 mA)

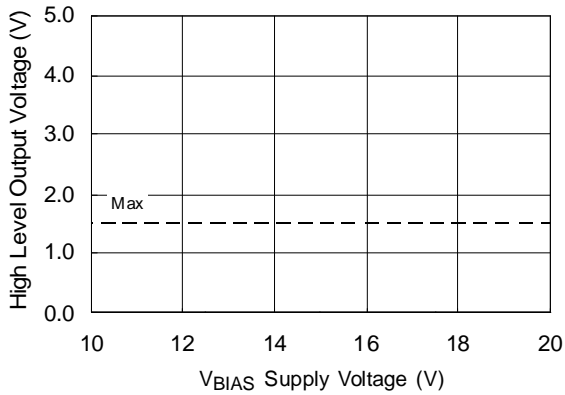


Figure 23B. High Level Output Voltage vs. Supply Voltage (I_O = 0 mA)

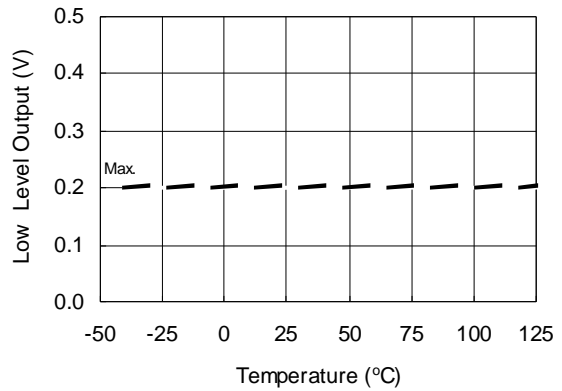


Figure 24A. Low Level Output vs. Temperature

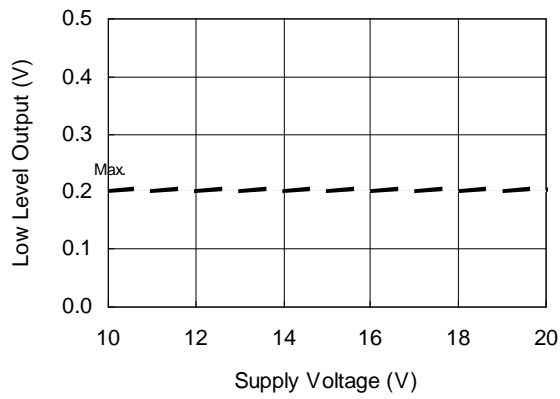


Figure 24B. Low Level Output vs. Supply Voltage

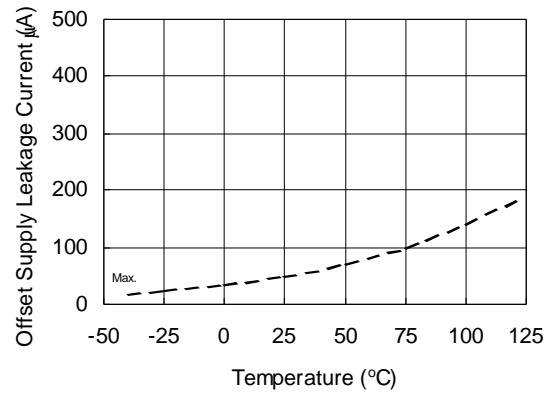


Figure 25A. Offset Supply Leakage Current vs. Temperature

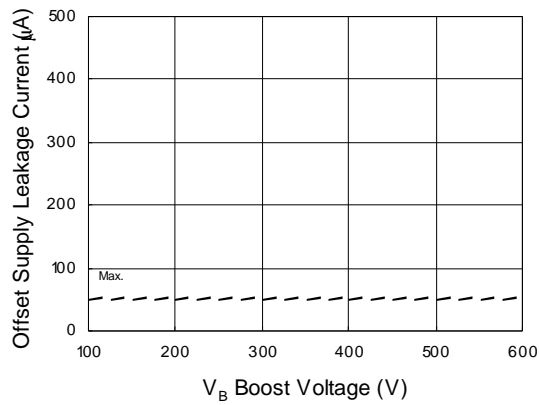


Figure 25B. Offset Supply Leakage Current vs. V_B Boost Voltage

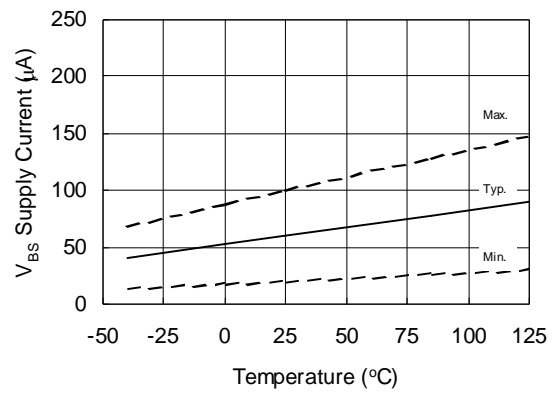


Figure 26A. V_{BS} Supply Current vs. Temperature

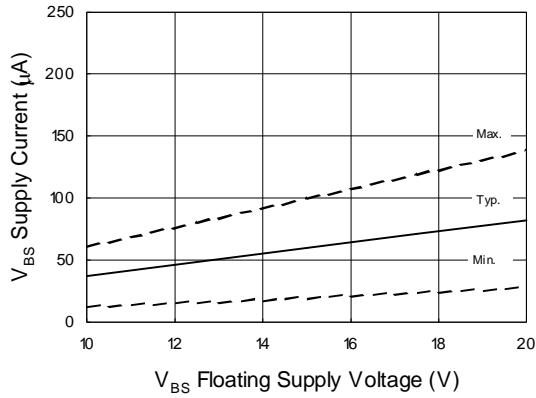


Figure 26B. V_{BS} Supply Current vs. V_{BS} Supply Voltage

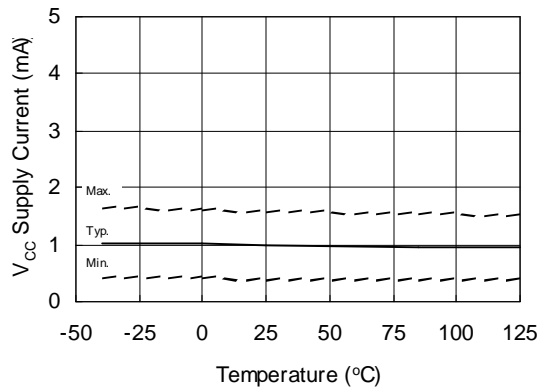


Figure 27A. V_{CC} Supply Current vs. Temperature

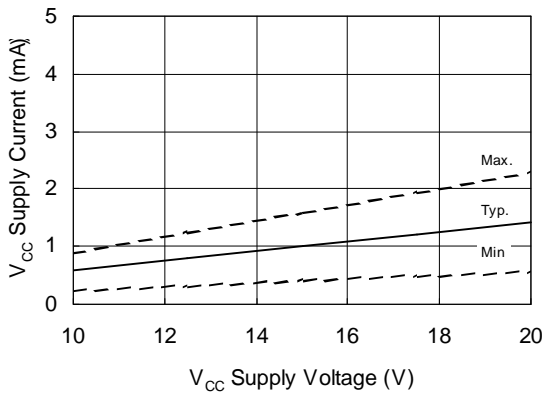


Figure 27B. V_{CC} Supply Current vs. V_{CC} Supply Voltage

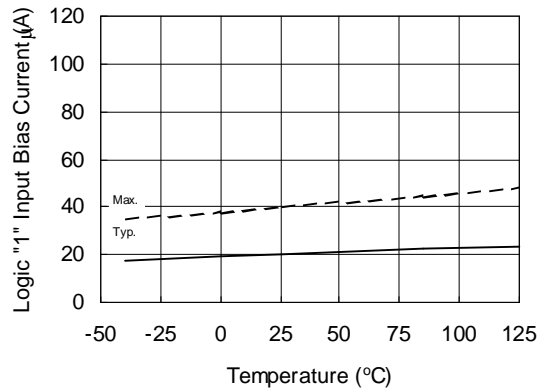


Figure 28A. Logic "1" Input Bias Current vs. Temperature

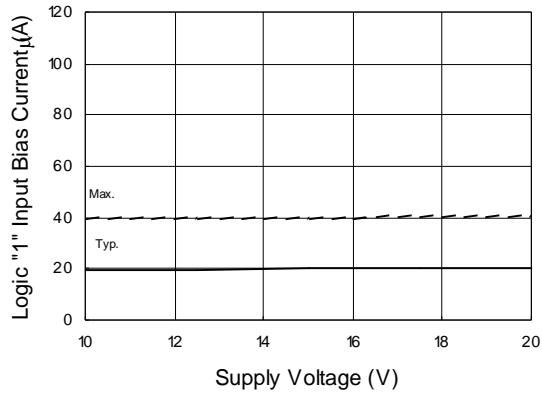


Figure 28B. Logic "1" Input Bias Current vs. Supply Voltage

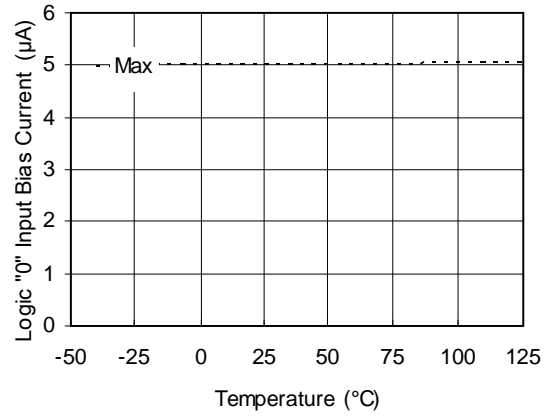


Figure 29A. Logic "0" Input Bias Current vs. Temperature

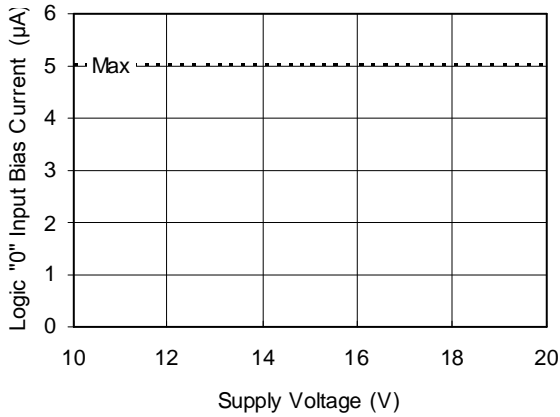


Figure 29B. Logic "0" Input Bias Current vs. Supply Voltage

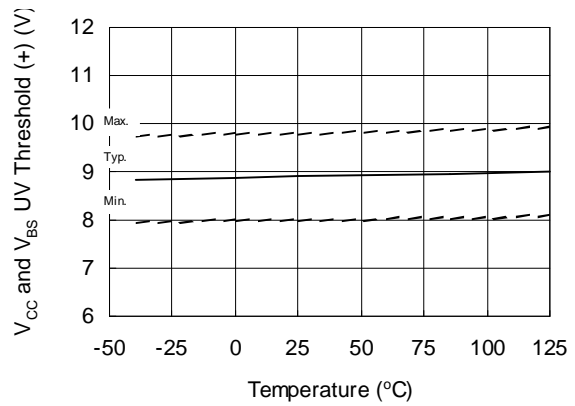


Figure 30. V_{CC} and V_{BS} Undervoltage Threshold (+) vs. Temperature

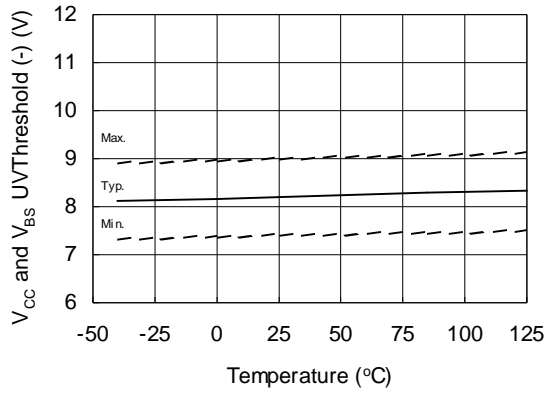


Figure 31. V_{CC} and V_{BS} Undervoltage Threshold (-) vs. Temperature

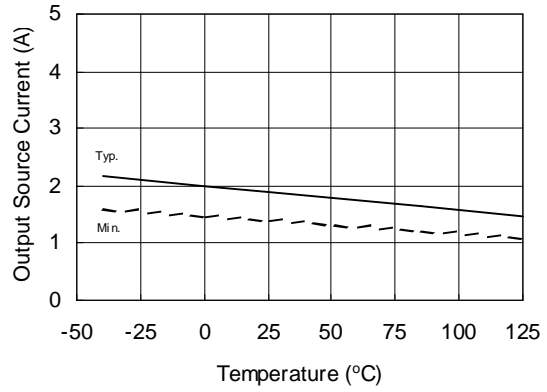


Figure 32A. Output Source Current vs. Temperature

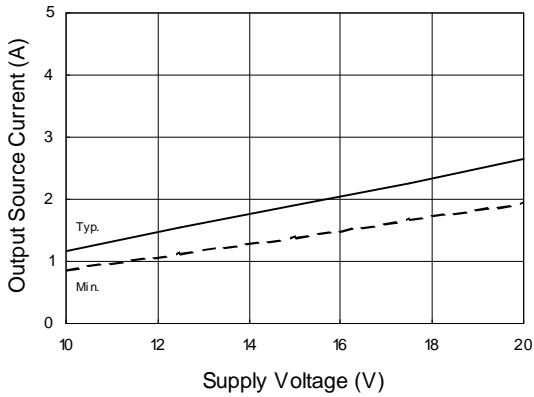


Figure 32B. Output Source Current vs. Supply Voltage

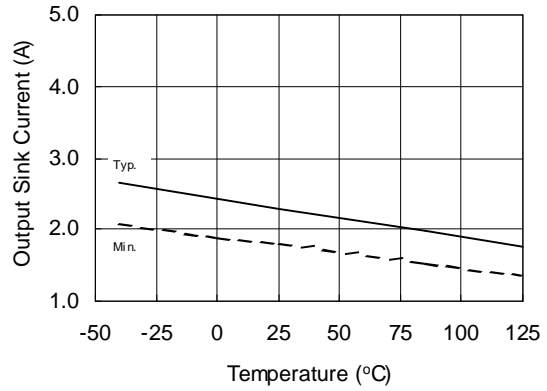


Figure 33A. Output Sink Current vs. Temperature

IRS2184/IRS21844(S)PbF

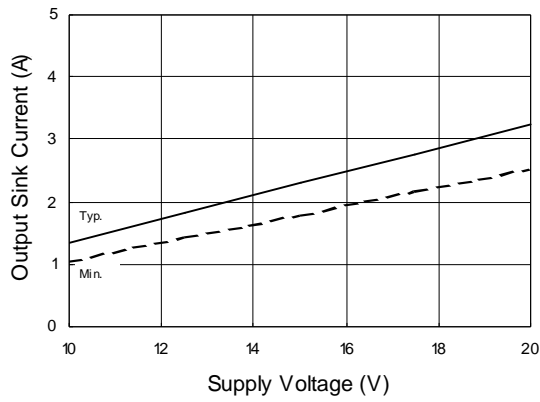


Figure 33B. Output Sink Current vs. Supply Voltage

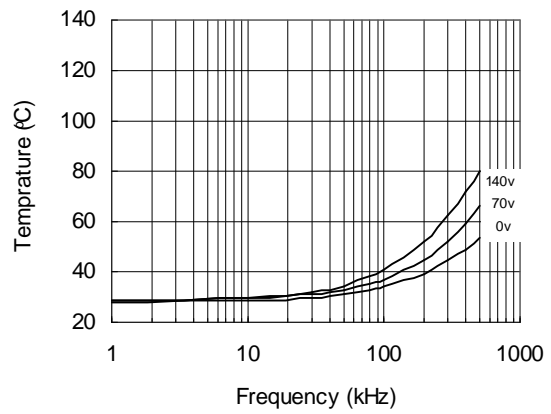


Figure 34. IRS2184 vs. Frequency (IRFBC20), $R_{gate} = 33\Omega$, $V_{CC} = 15V$

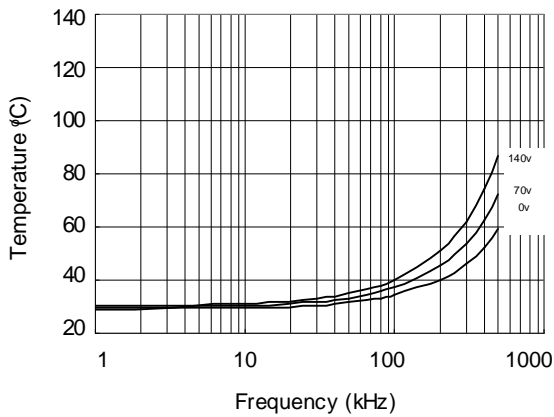


Figure 35. IRS2184 vs. Frequency (IRFBC30), $R_{gate} = 22\Omega$, $V_{CC} = 15V$

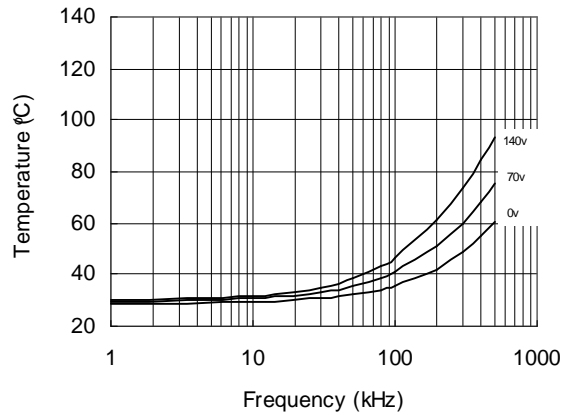
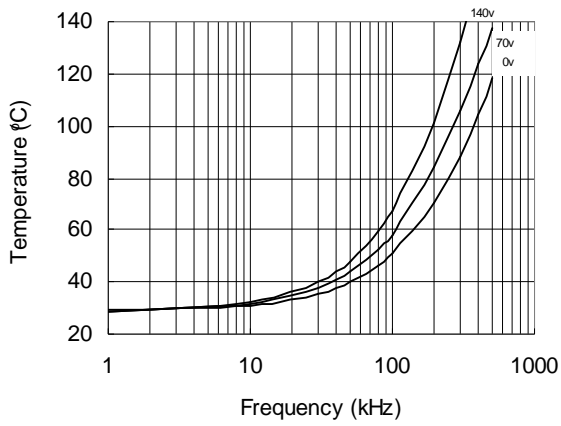
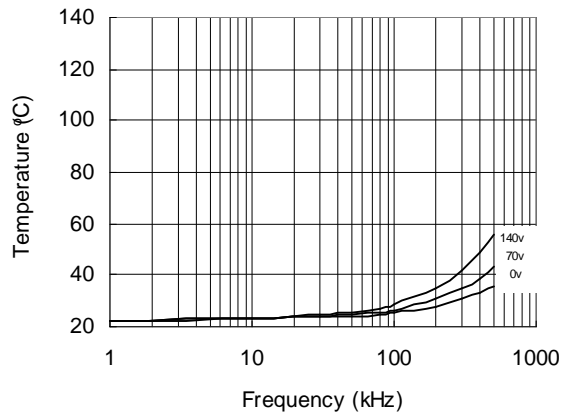


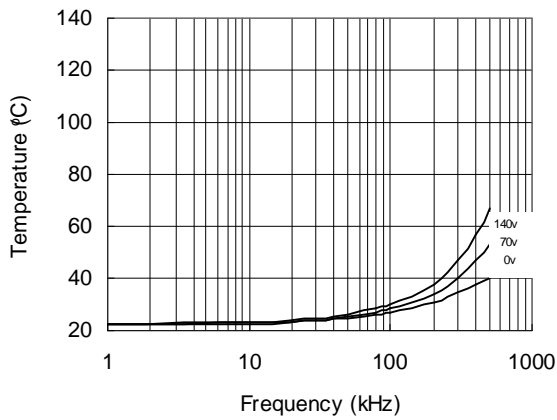
Figure 36. IRS2184 vs. Frequency (IRFBC40), $R_{gate} = 15\Omega$, $V_{CC} = 15V$



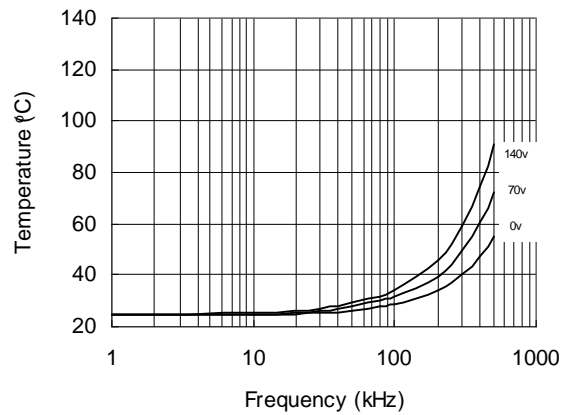
**Figure 37. IRS2184 vs. Frequency (IRFBC50),
 $R_{gate} = 10\Omega$, $V_{cc} = 15V$**



**Figure 38. IRS21844 vs. Frequency (IRFBC20),
 $R_{gate} = 33\Omega$, $V_{cc} = 15V$**

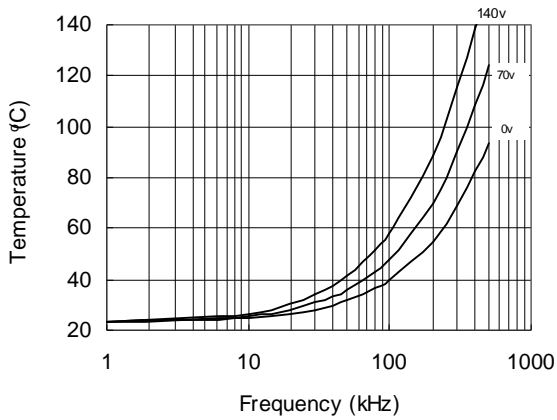


**Figure 39. IRS21844 vs. Frequency (IRFBC30),
 $R_{gate} = 22\Omega$, $V_{cc} = 15V$**

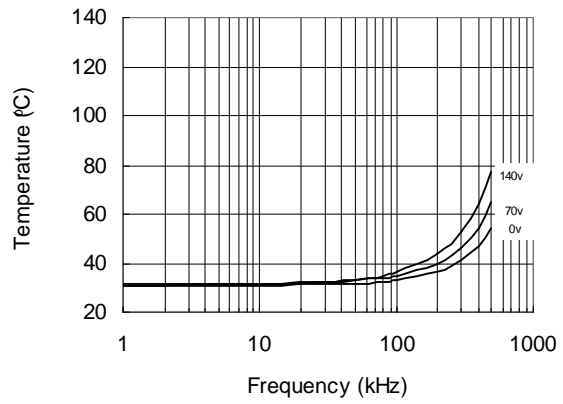


**Figure 40. IRS21844 vs. Frequency (IRFBC40),
 $R_{gate} = 15\Omega$, $V_{cc} = 15V$**

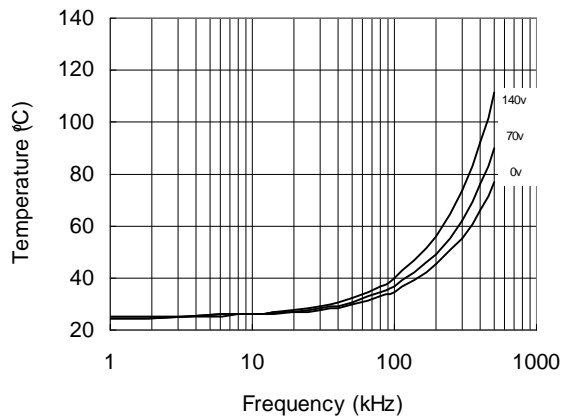
IRS2184/IRS21844(S)PbF



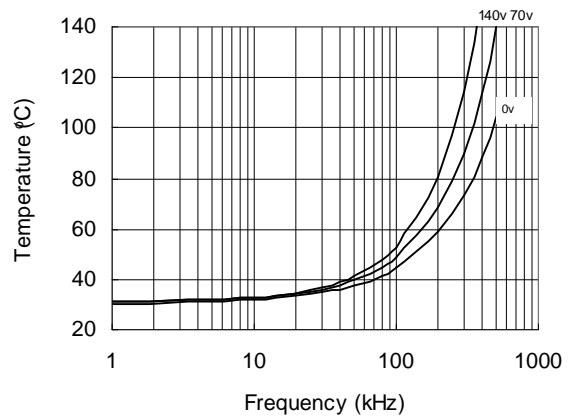
**Figure 41. IRS21844 vs. Frequency (IRFBC50),
 $R_{gate} = 10\Omega$, $V_{cc} = 15V$**



**Figure 42. IRS2184s vs. Frequency (IRFBC20),
 $R_{gate} = 33\Omega$, $V_{cc} = 15V$**



**Figure 43. IRS2184s vs. Frequency (IRFBC30),
 $R_{gate} = 22\Omega$, $V_{cc} = 15V$**



**Figure 44. IRS2184s vs. Frequency (IRFBC40),
 $R_{gate} = 15\Omega$, $V_{cc} = 15V$**

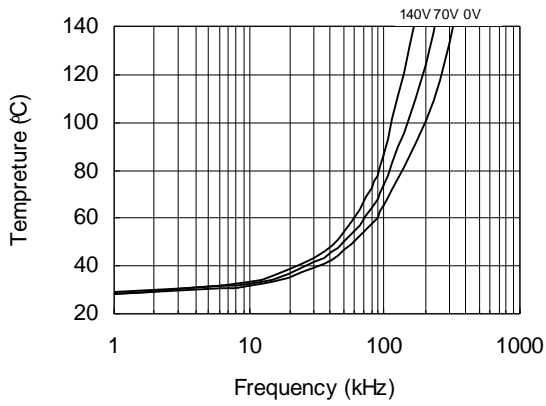


Figure 45. IRS2184s vs. Frequency (IRFBC50),
 $R_{gate} = 10\Omega$, $V_{cc} = 15V$

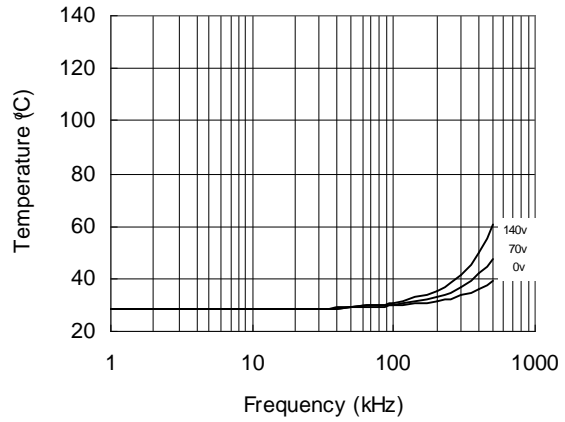


Figure 46. IRS21844s vs. Frequency (IRFBC20),
 $R_{gate} = 33\Omega$, $V_{cc} = 15V$

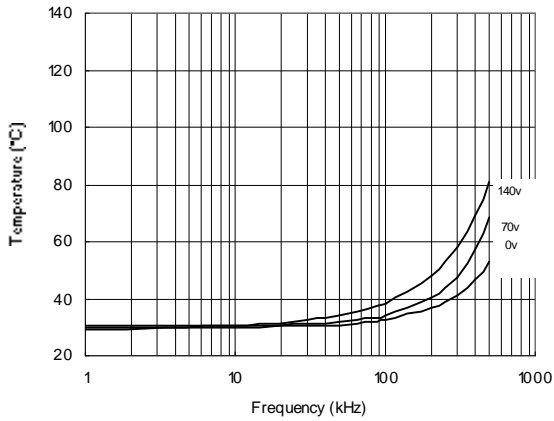


Figure 47. IRS21844s vs. Frequency (IRFBC30),
 $R_{gate} = 22\Omega$, $V_{cc} = 15V$

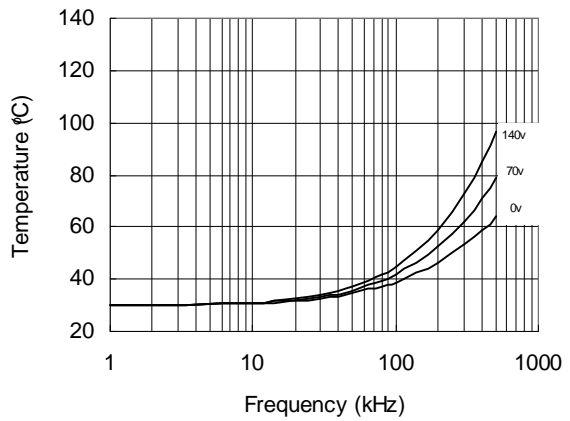


Figure 48. IRS21844s vs. Frequency (IRFBC40),
 $R_{gate} = 15\Omega$, $V_{cc} = 15V$

IRS2184/IRS21844(S)PbF

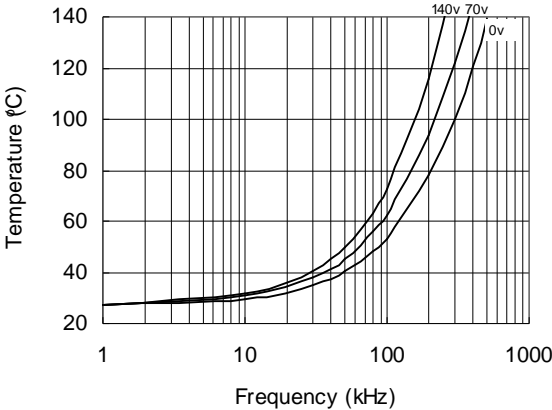
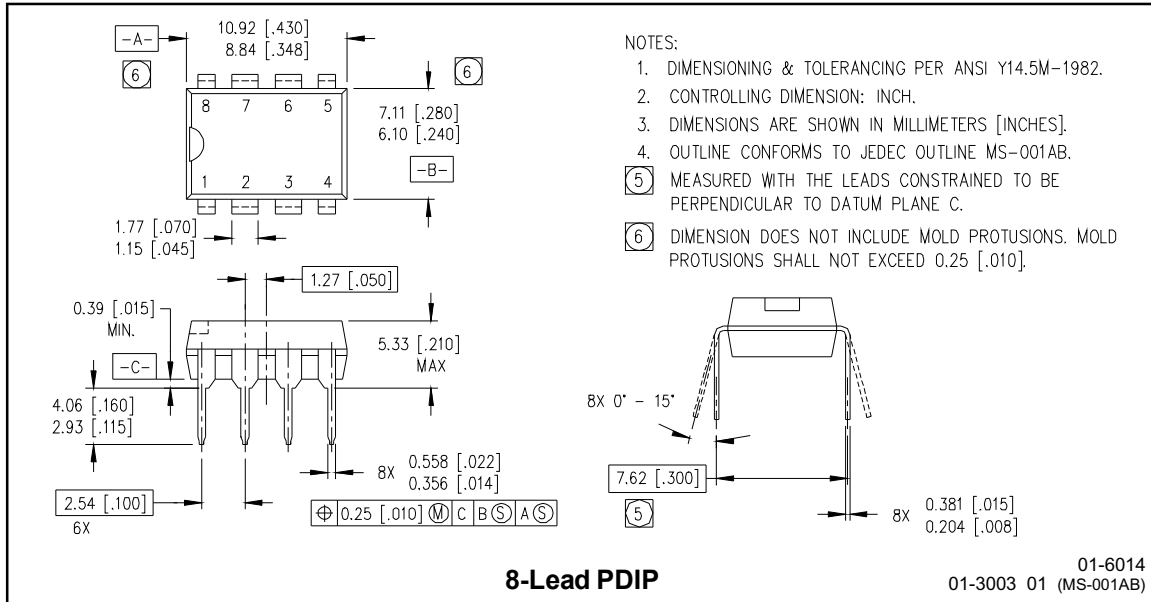
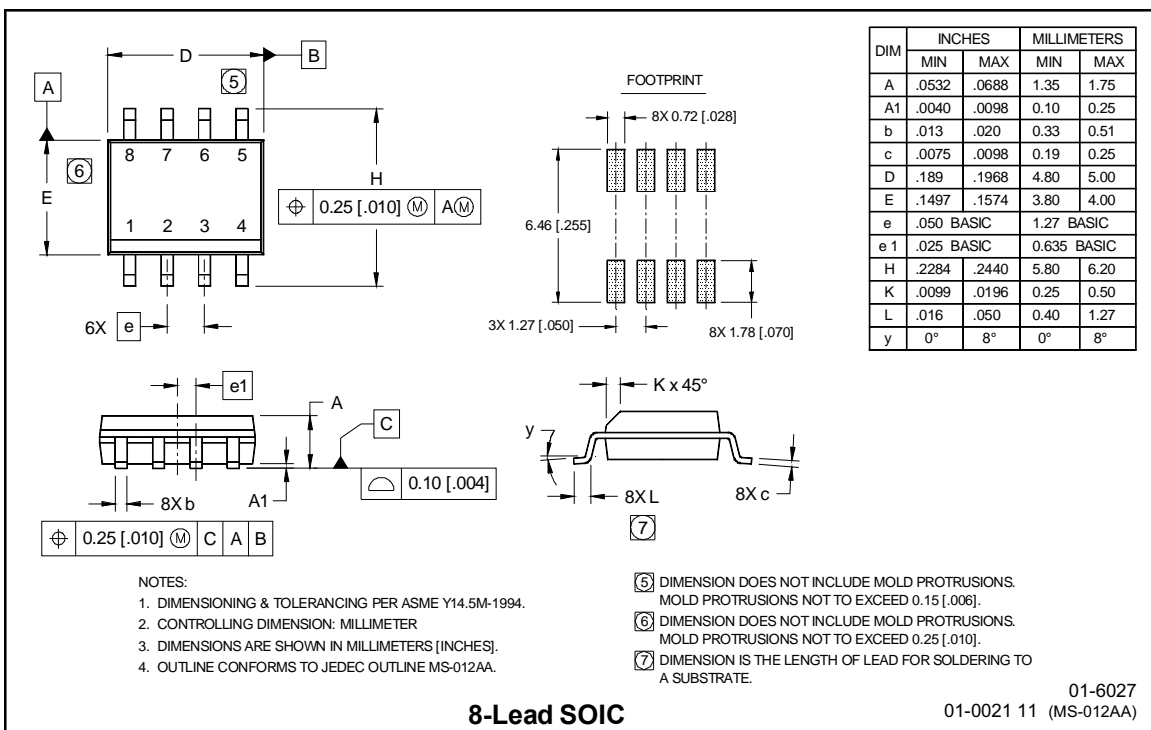


Figure 49. IRS21844s vs. Frequency (IRFBC50),
 $R_{gate} = 10\Omega$, $V_{cc} = 15V$

Cast Outlines

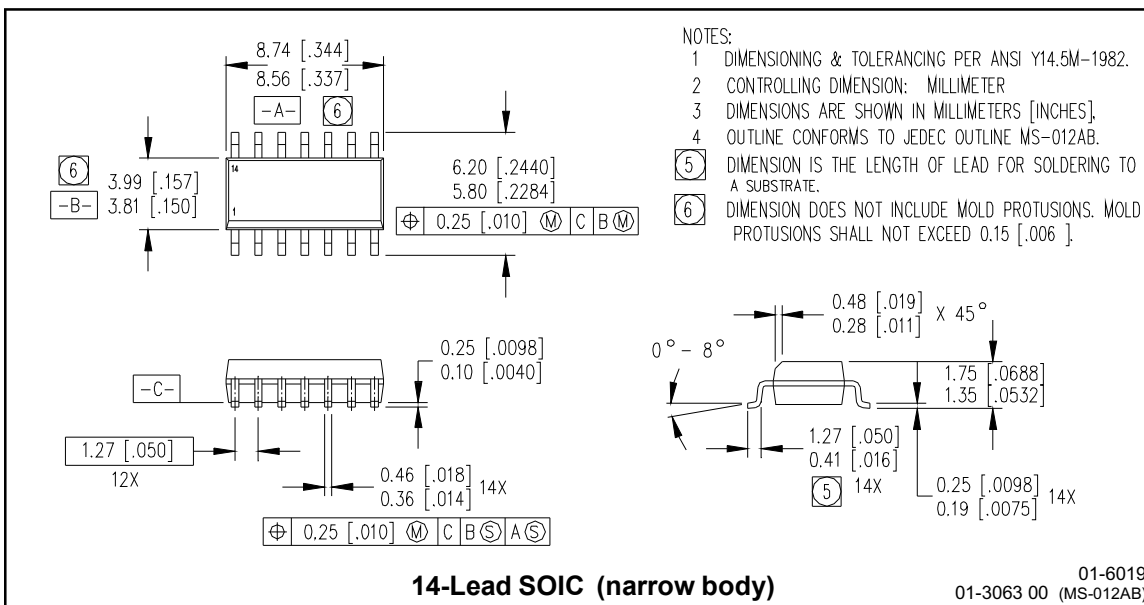
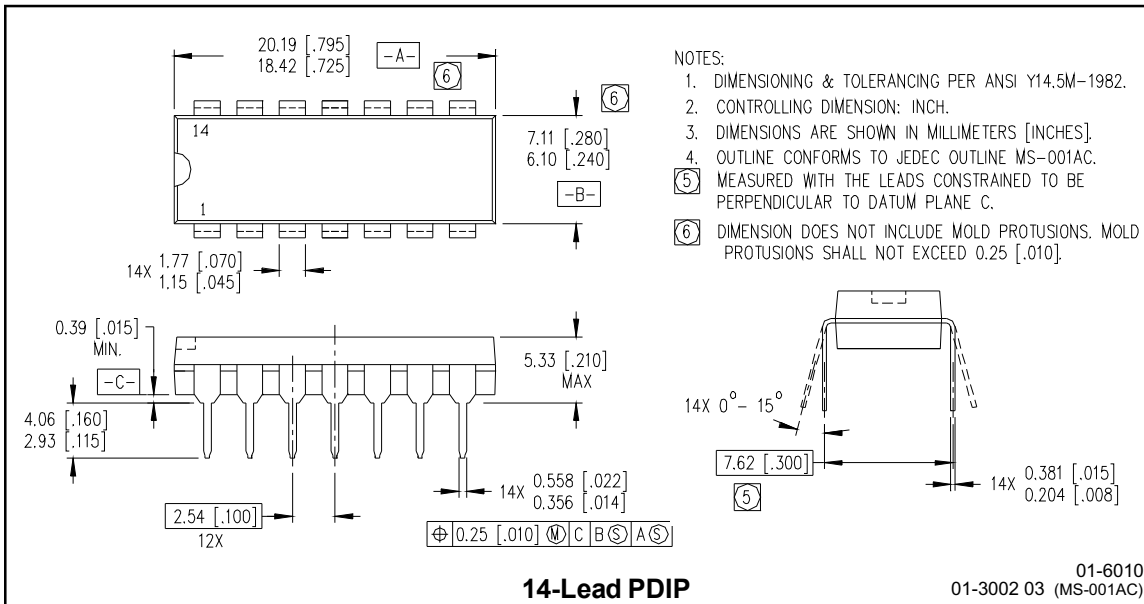


8-Lead PDIP

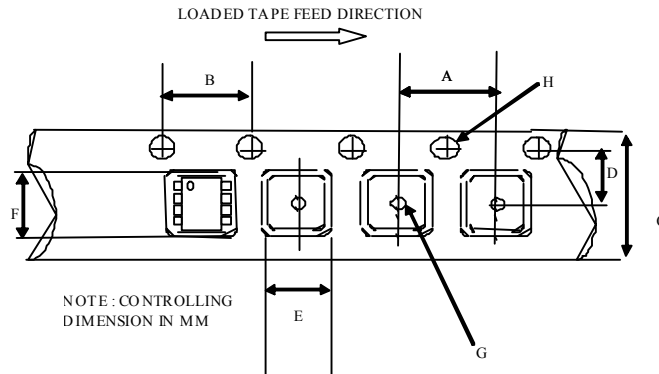


8-Lead SOIC

IRS2184/IRS21844(S)PbF

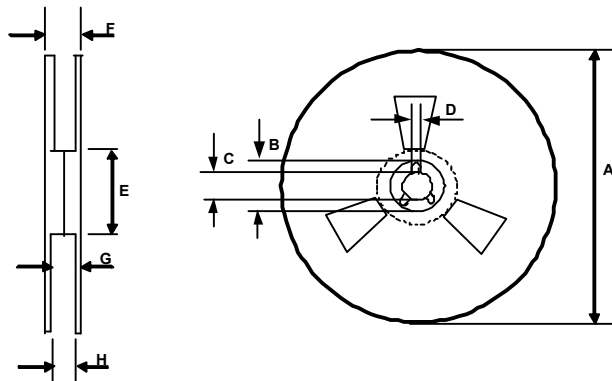


Tape & Reel 8-lead SOIC



CARRIER TAPE DIMENSION FOR 8SOICN

Code	Metric		Imperial	
	Min	Max	Min	Max
A	7.90	8.10	0.311	0.318
B	3.90	4.10	0.153	0.161
C	11.70	12.30	0.46	0.484
D	5.45	5.55	0.214	0.218
E	6.30	6.50	0.248	0.255
F	5.10	5.30	0.200	0.208
G	1.50	n/a	0.059	n/a
H	1.50	1.60	0.059	0.062

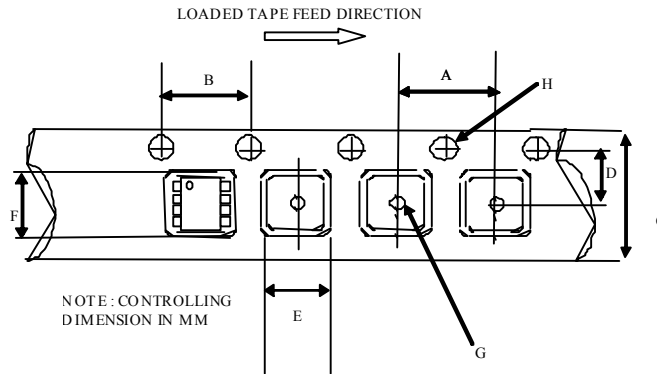


REEL DIMENSIONS FOR 8SOICN

Code	Metric		Imperial	
	Min	Max	Min	Max
A	329.60	330.25	12.976	13.001
B	20.95	21.45	0.824	0.844
C	12.80	13.20	0.503	0.519
D	1.95	2.45	0.767	0.096
E	98.00	102.00	3.858	4.015
F	n/a	18.40	n/a	0.724
G	14.50	17.10	0.570	0.673
H	12.40	14.40	0.488	0.566

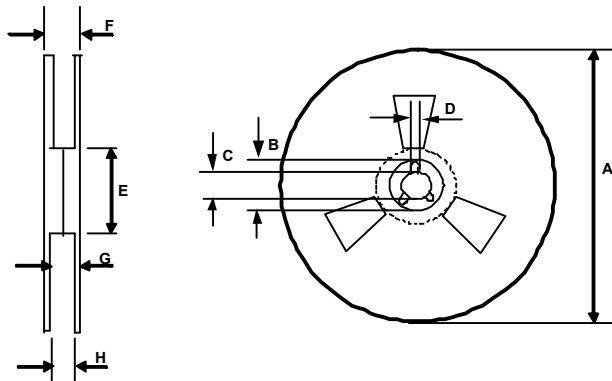
IRS2184/IRS21844(S)PbF

Tape & Reel 14-lead SOIC



CARRIER TAPE DIMENSION FOR 14SOICN

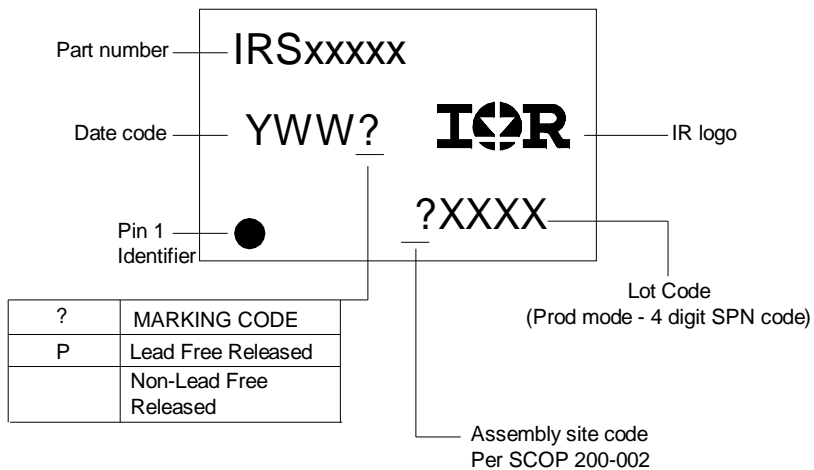
Code	Metric		Imperial	
	Min	Max	Min	Max
A	7.90	8.10	0.311	0.318
B	3.90	4.10	0.153	0.161
C	15.70	16.30	0.618	0.641
D	7.40	7.60	0.291	0.299
E	6.40	6.60	0.252	0.260
F	9.40	9.60	0.370	0.378
G	1.50	n/a	0.059	n/a
H	1.50	1.60	0.059	0.062



REEL DIMENSIONS FOR 14SOICN

Code	Metric		Imperial	
	Min	Max	Min	Max
A	329.60	330.25	12.976	13.001
B	20.95	21.45	0.824	0.844
C	12.80	13.20	0.503	0.519
D	1.95	2.45	0.767	0.096
E	98.00	102.00	3.858	4.015
F	n/a	22.40	n/a	0.881
G	18.50	21.10	0.728	0.830
H	16.40	18.40	0.645	0.724

LEADFREE PART MARKING INFORMATION



ORDER INFORMATION

- | | |
|---------------------------------------|---|
| 8-Lead PDIP IRS2184PbF | 14-Lead PDIP IR2S1844PbF |
| 8-Lead SOIC IRS2184SPbF | 14-Lead SOIC IRS21844SPbF |
| 8-Lead SOIC Tape & Reel IRS2184STRPbF | 14-Lead SOIC Tape & Reel IRS21844STRPbF |

Компания «Life Electronics» занимается поставками электронных компонентов импортного и отечественного производства от производителей и со складов крупных дистрибьюторов Европы, Америки и Азии.

С конца 2013 года компания активно расширяет линейку поставок компонентов по направлению коаксиальный кабель, кварцевые генераторы и конденсаторы (керамические, пленочные, электролитические), за счёт заключения дистрибьюторских договоров

Мы предлагаем:

- Конкурентоспособные цены и скидки постоянным клиентам.
- Специальные условия для постоянных клиентов.
- Подбор аналогов.
- Поставку компонентов в любых объемах, удовлетворяющих вашим потребностям.
- Приемлемые сроки поставки, возможна ускоренная поставка.
- Доставку товара в любую точку России и стран СНГ.
- Комплексную поставку.
- Работу по проектам и поставку образцов.
- Формирование склада под заказчика.
- Сертификаты соответствия на поставляемую продукцию (по желанию клиента).
- Тестирование поставляемой продукции.
- Поставку компонентов, требующих военную и космическую приемку.
- Входной контроль качества.
- Наличие сертификата ISO.

В составе нашей компании организован Конструкторский отдел, призванный помогать разработчикам, и инженерам.

Конструкторский отдел помогает осуществить:

- Регистрацию проекта у производителя компонентов.
- Техническую поддержку проекта.
- Защиту от снятия компонента с производства.
- Оценку стоимости проекта по компонентам.
- Изготовление тестовой платы монтаж и пусконаладочные работы.



Тел: +7 (812) 336 43 04 (многоканальный)
Email: org@lifeelectronics.ru