

Features

- Formerly **FulTec** brand
- Extremely high speed performance
- Low impedance
- Two TBU® protectors in one small package
- Very high bandwidth, GHz compatible
- Simple, superior circuit protection
- RoHS compliant*, UL Recognized

Applications

- xDSL (ADSL, VDSL, VDSL2)
- High Data Rate Interface IC protection (LVDS, HDMI, etc.)
- Industrial sensors and controls
- General electronics

P40-G Series TBU® High-Speed Protectors

Transient Blocking Units - TBU® Devices

Bourns® Model P40-G products are high-speed bidirectional protection components, constructed using MOSFET semiconductor technology, designed to protect against faults caused by short circuits, AC power cross, induction and lightning surges.

The TBU® high-speed protector, triggering as a function of the MOSFET, blocks surges and provides an effective barrier behind which sensitive electronics are not exposed to large voltages or currents during surge events. The TBU® device is provided in a surface mount DFN package and meets industry standard requirements such as RoHS and Pb Free solder reflow profiles.

Agency Approval

UL recognized component File # E315805.

Industry Standards

Description		Model
Telcordia	GR-1089	P40-G
ITU-T	K.20, K.20E, K.21, K.21E, K.45	

Absolute Maximum Ratings ($T_{amb} = 25\text{ }^{\circ}\text{C}$)

Symbol	Parameter	Value	Unit
V_{imp}	Maximum protection voltage for impulse faults with rise time $\geq 1\text{ }\mu\text{sec}$	40	V
V_{rms}	Maximum protection voltage for continuous V_{rms} faults	28	V
T_{op}	Operating temperature range	-40 to +85	$^{\circ}\text{C}$
T_{stg}	Storage temperature range	-65 to +150	$^{\circ}\text{C}$

Electrical Characteristics ($T_{amb} = 25\text{ }^{\circ}\text{C}$)

Symbol	Parameter	Min.	Typ.	Max.	Unit
I_{op}	Maximum current through the device that will not cause current blocking			240	mA
$I_{trigger}$	Typical current for the device to go from normal operating state to protected state		350		mA
I_{out}	Maximum current through the device			480	mA
R_{device}	Series resistance of the TBU® device		3.6	4.2	Ω
R_{bal}	Line-to-line series resistance difference between two TBU® devices			5	%
t_{block}	Maximum time for the device to go from normal operating state to protected state			0.2	μs
$I_{quiescent}$	Current through the triggered TBU® device with 40 Vdc circuit voltage		0.7		mA
V_{reset}	Voltage below which the triggered TBU® device will transition to normal operating state		7		V

The P40-G Series TBU® high-speed protector is bidirectional; specifications are valid in both directions.

*RoHS Directive 2002/95/EC Jan. 27, 2003 including annex and RoHS Recast 2011/65/EU June 8, 2011. Specifications are subject to change without notice. Customers should verify actual device performance in their specific applications.

P40-G Series TBU[®] High-Speed Protectors

BOURNS[®]

Typical Performance Characteristics

V-I Characteristics

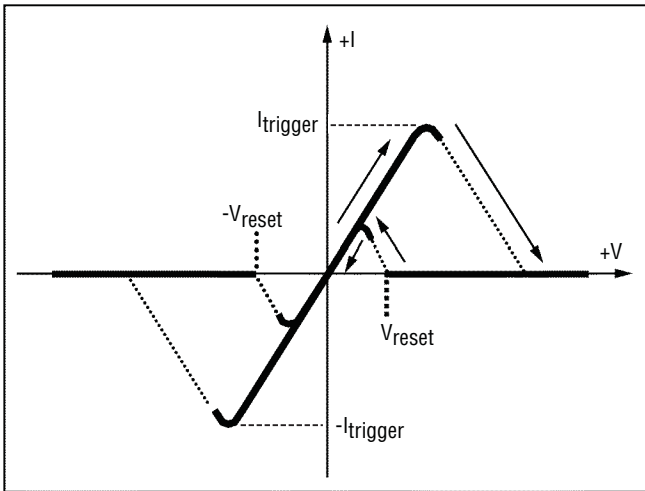

Time to Block vs. Fault Current

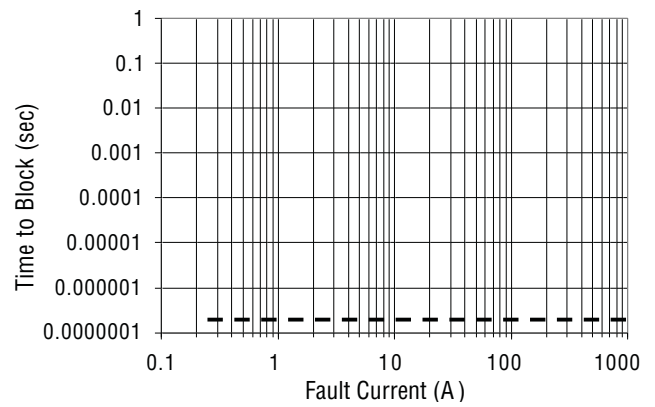

Trigger Current vs. Temperature

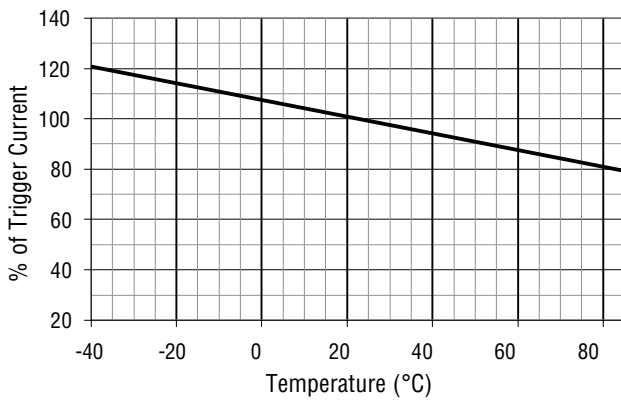

P40-G Series TBU® High-Speed Protectors

BOURNS®

Operational Characteristics

The graph below demonstrates the operational characteristics of the TBU® device. In the graph below the fault voltage, protected side voltage, and current is presented.

TEST CONFIGURATION DIAGRAM

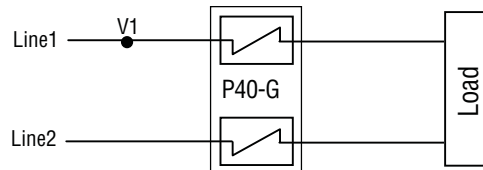

P40-G Lightning Protection 40 V

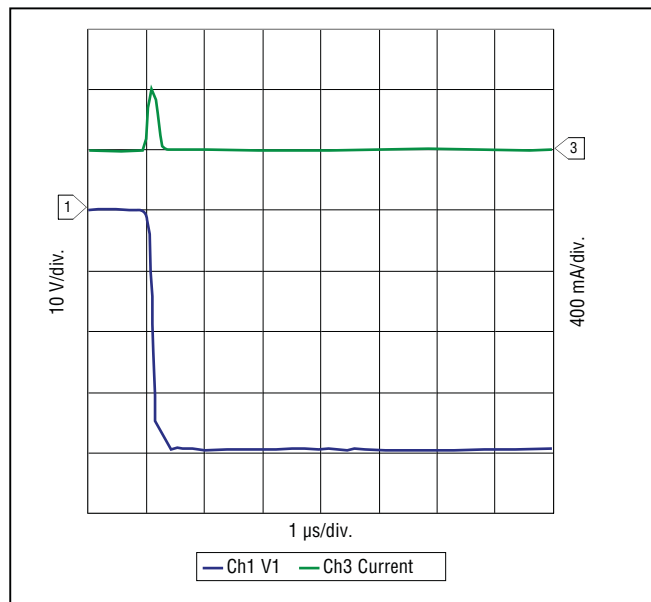

P40-G Series TBU® High-Speed Protectors

BOURNS®

Product Dimensions

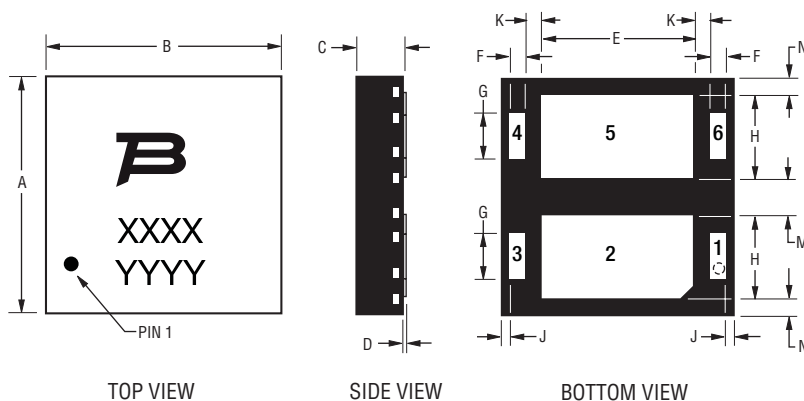

Dim.	Min.	Typ.	Max.
A	$\frac{3.90}{(.154)}$	$\frac{4.00}{(.157)}$	$\frac{4.10}{(.161)}$
B	$\frac{3.90}{(.154)}$	$\frac{4.00}{(.157)}$	$\frac{4.10}{(.161)}$
C	$\frac{0.80}{(.031)}$	$\frac{0.85}{(.033)}$	$\frac{0.90}{(.035)}$
D	$\frac{0.000}{(.000)}$	$\frac{0.025}{(.001)}$	$\frac{0.050}{(.002)}$
E	$\frac{2.55}{(.100)}$	$\frac{2.60}{(.102)}$	$\frac{2.65}{(.104)}$
F	$\frac{0.20}{(.008)}$	$\frac{0.25}{(.010)}$	$\frac{0.30}{(.012)}$
G	$\frac{0.75}{(.030)}$	$\frac{0.80}{(.031)}$	$\frac{0.85}{(.033)}$
H	$\frac{1.40}{(.055)}$	$\frac{1.45}{(.057)}$	$\frac{1.50}{(.059)}$
J	$\frac{0.10}{(.004)}$	$\frac{0.15}{(.006)}$	$\frac{0.20}{(.008)}$
K	$\frac{0.25}{(.010)}$	$\frac{0.30}{(.012)}$	$\frac{0.35}{(.014)}$
M	$\frac{0.55}{(.022)}$	$\frac{0.60}{(.024)}$	$\frac{0.65}{(.026)}$
N	$\frac{0.20}{(.008)}$	$\frac{0.25}{(.010)}$	$\frac{0.30}{(.012)}$

Recommended Pad Layout

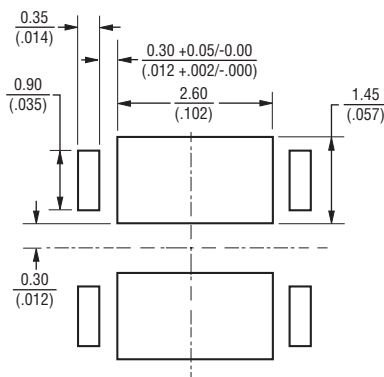

Pad Designation

Pad #	Apply
1	In1
2	NC
3	Out1
4	Out2
5	NC
6	In2

NC = Solder to PCB; do not make electrical connection, do not connect to ground.

DIMENSIONS: $\frac{\text{MM}}{(\text{INCHES})}$

Block Diagram

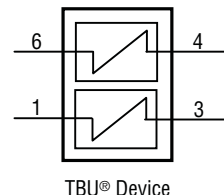

TBU® devices have matte-tin termination finish. Suggested layout should use non-solder mask define (NSMD). Recommended stencil thickness is 0.10-0.12 mm (.004-.005 in.) with stencil opening size 0.025 mm (.0010 in.) less than the device pad size. As when heat sinking any power device, it is recommended that, wherever possible, extra PCB copper area is allowed. For minimum parasitic capacitance, do not allow any signal, ground or power signals beneath any of the pads of the device.

Thermal Resistances

Thermal resistance using minimal pad size, where the power is the total power dissipated in the package. Additional copper pad area to be used for additional heatsinking is also recommended.

Symbol	Parameter	Value	Unit
Rth(j-a)	Junction to Package Pads (1 TBU of Pair)	250	°C/W
Rth(j-a)	Junction to Package Pads (2 TBUs of Equal Power)	180	°C/W

P40-G Series TBU® High-Speed Protectors

BOURNS®

Reflow Profile

Profile Feature	Pb-Free Assembly
Average Ramp-Up Rate (T _{smax} to T _p)	3 °C/sec. max.
Preheat	
- Temperature Min. (T _{smin})	150 °C
- Temperature Max. (T _{smax})	200 °C
- Time (t _{smin} to t _{smax})	60-180 sec.
Time maintained above:	
- Temperature (T _L)	217 °C
- Time (t _L)	60-150 sec.
Peak/Classification Temperature (T _p)	260 °C
Time within 5 °C of Actual Peak Temp. (t _p)	20-40 sec.
Ramp-Down Rate	6 °C/sec. max.
Time 25 °C to Peak Temperature	8 min. max.

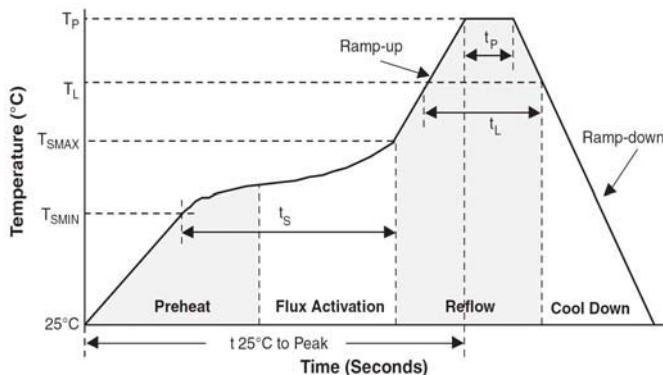

How to Order

P 40 - G 240 - WH

- Form Factor _____
- P = Two TBU® protectors in one device
- Impulse Voltage Rating _____
- 40 = 40 V
- Directional Indication _____
- G = Bidirectional
- Iop Indicator _____
- 240 = 240 mA

Typical Part Marking

MANUFACTURER'S TRADEMARK*

MARKING NUMBER
04GC = P40-G240-WH

PIN 1

MANUFACTURING DATE CODE*

- 1ST DIGIT INDICATES THE YEAR'S 6-MONTH PERIOD.
- 2ND DIGIT INDICATES THE WEEK NUMBER IN THE 6-MONTH PERIOD.
- 3RD & 4TH DIGITS INDICATE SPECIFIC LOT FOR THE WEEK.

6-MONTH PERIOD CODES:

A = JAN-JUN 2009	C = JAN-JUN 2010	E = JAN-JUN 2011
B = JUL-DEC 2009	D = JUL-DEC 2010	F = JUL-DEC 2011

EXAMPLE: ARBC

- 1ST DIGIT 'A' = JAN-JUN 2009
- 2ND DIGIT 'R' = WEEK 18; WEEK OF APRIL 27
- 3RD & 4TH DIGITS 'BC' = LOT SPECIFIC INFORMATION

*TRANSITION FROM FULTEC TRADEMARK AND LOT CODE TO BOURNS TRADEMARK AND DATE CODE IN 2009.

P40-G Series TBU® High-Speed Protectors

BOURNS®

Packaging Specifications (per EIA468-B)

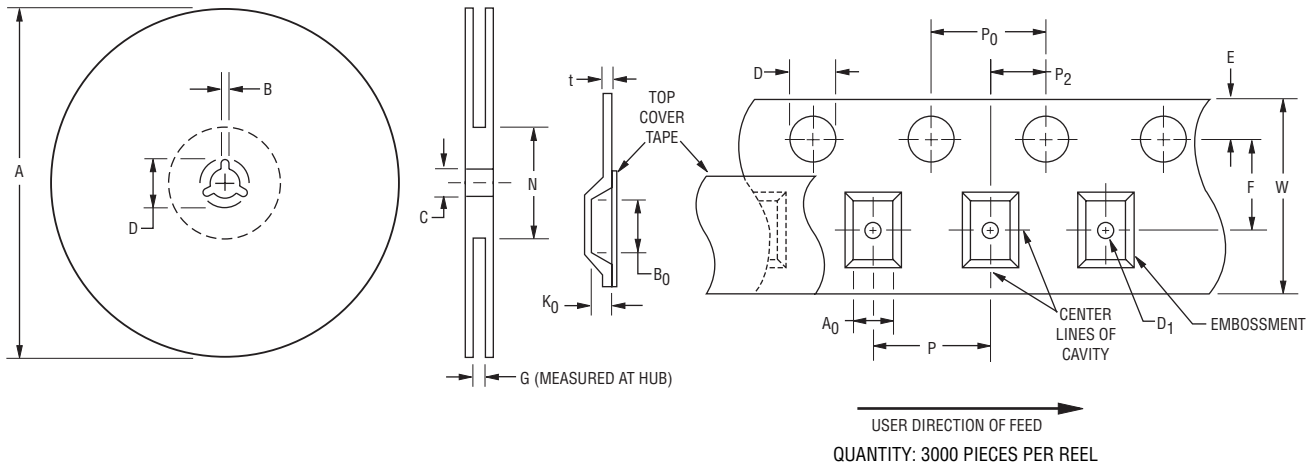

Device	A		B		C		D		G	N
	Min.	Max.	Min.	Max.	Min.	Max.	Min.	Max.	Ref.	Ref.
P40-G240	$\frac{326}{(12.835)}$	$\frac{330.25}{(13.002)}$	$\frac{1.5}{(.059)}$	$\frac{2.5}{(.098)}$	$\frac{12.8}{(.504)}$	$\frac{13.5}{(.531)}$	$\frac{20.2}{(.795)}$	-	$\frac{12.4}{(.488)}$	$\frac{102}{(4.016)}$

Device	A ₀		B ₀		D		D ₁		E		F	
	Min.	Max.	Min.	Max.	Min.	Max.	Min.	Max.	Min.	Max.	Min.	max.
P40-G240	$\frac{4.2}{(.165)}$	$\frac{4.4}{(.173)}$	$\frac{4.2}{(.165)}$	$\frac{4.4}{(.173)}$	$\frac{1.5}{(.059)}$	$\frac{1.6}{(.063)}$	$\frac{1.5}{(.059)}$	-	$\frac{1.65}{(.065)}$	$\frac{1.85}{(.073)}$	$\frac{5.45}{(.216)}$	$\frac{5.55}{(.219)}$

Device	K ₀		P		P ₀		P ₂		t		W	
	Min.	Max.	Min.	Max.	Min.	Max.	Min.	Max.	Min.	Max.	Min.	Max.
P40-G240	$\frac{1.05}{(.041)}$	$\frac{1.25}{(.049)}$	$\frac{7.9}{(.311)}$	$\frac{8.1}{(.319)}$	$\frac{3.9}{(.159)}$	$\frac{4.1}{(.161)}$	$\frac{1.9}{(.075)}$	$\frac{2.1}{(.083)}$	$\frac{0.25}{(.010)}$	$\frac{0.35}{(.014)}$	$\frac{11.7}{(.461)}$	$\frac{12.3}{(.484)}$

DIMENSIONS: $\frac{\text{MM}}{\text{(INCHES)}}$

P40-G Series TBU® High-Speed Protectors

BOURNS®

Reference Application

A cost-effective protection solution combines the Bourns® TBU® protection device with a diode bridge on the driver side of the transformer and GDTs on the line side. The GDT should have a minimum DCBD of 900 V and a maximum sparkover voltage of 1600 V. The diagram below illustrates a common configuration of these components. The graph demonstrates the operational characteristics of the circuit.

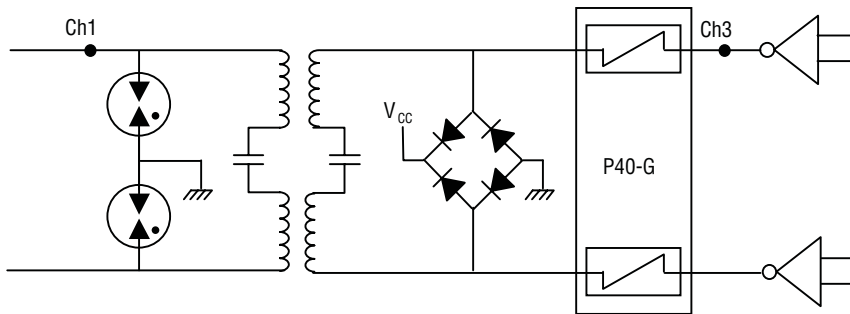

Common Configuration Diagram - xDSL Protection

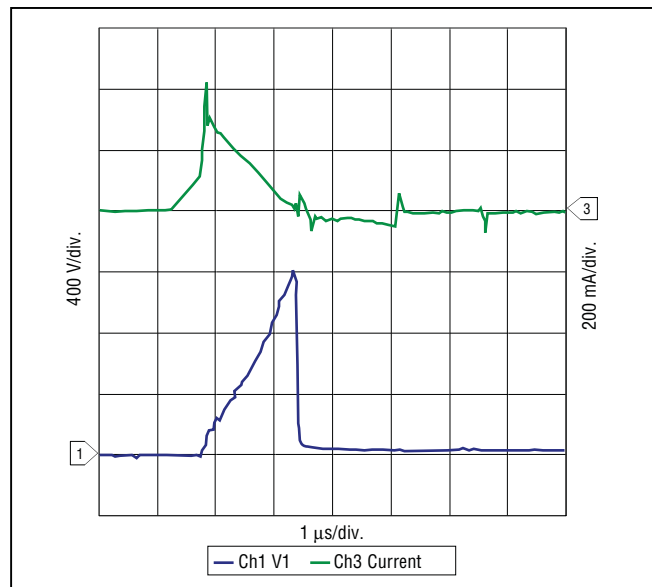

5000 V Lightning 2/10 μsec, 500 A

BOURNS®

Asia-Pacific: Tel: +886-2 2562-4117 • Fax: +886-2 2562-4116

Europe: Tel: +41-41 768 5555 • Fax: +41-41 768 5510

The Americas: Tel: +1-951 781-5500 • Fax: +1-951 781-5700

www.bourns.com

REV. 04/12

"TBU" is a registered trademark of Bourns, Inc. in the United States and other countries. Specifications are subject to change without notice. Customers should verify actual device performance in their specific applications.

Компания «Life Electronics» занимается поставками электронных компонентов импортного и отечественного производства от производителей и со складов крупных дистрибьюторов Европы, Америки и Азии.

С конца 2013 года компания активно расширяет линейку поставок компонентов по направлению коаксиальный кабель, кварцевые генераторы и конденсаторы (керамические, пленочные, электролитические), за счёт заключения дистрибьюторских договоров

Мы предлагаем:

- Конкурентоспособные цены и скидки постоянным клиентам.
- Специальные условия для постоянных клиентов.
- Подбор аналогов.
- Поставку компонентов в любых объемах, удовлетворяющих вашим потребностям.
- Приемлемые сроки поставки, возможна ускоренная поставка.
- Доставку товара в любую точку России и стран СНГ.
- Комплексную поставку.
- Работу по проектам и поставку образцов.
- Формирование склада под заказчика.
- Сертификаты соответствия на поставляемую продукцию (по желанию клиента).
- Тестирование поставляемой продукции.
- Поставку компонентов, требующих военную и космическую приемку.
- Входной контроль качества.
- Наличие сертификата ISO.

В составе нашей компании организован Конструкторский отдел, призванный помогать разработчикам, и инженерам.

Конструкторский отдел помогает осуществить:

- Регистрацию проекта у производителя компонентов.
- Техническую поддержку проекта.
- Защиту от снятия компонента с производства.
- Оценку стоимости проекта по компонентам.
- Изготовление тестовой платы монтаж и пусконаладочные работы.



Тел: +7 (812) 336 43 04 (многоканальный)

Email: org@lifeelectronics.ru