

FLORENTINA-1-O

~45° + 15° oval beam

TECHNICAL SPECIFICATIONS:

Dimensions	39.7 mm
Height	13 mm
Fastening	tape
ROHS compliant	yes ⓘ

MATERIAL SPECIFICATIONS:

Component	Type	Material	Colour	Finish
ROSE-CMC-O	Single lens	PC	clear	
FLORENTINA-1-HLD	Holder	PC	black	
ROSE-TAPE	Tape	PU tape	black	



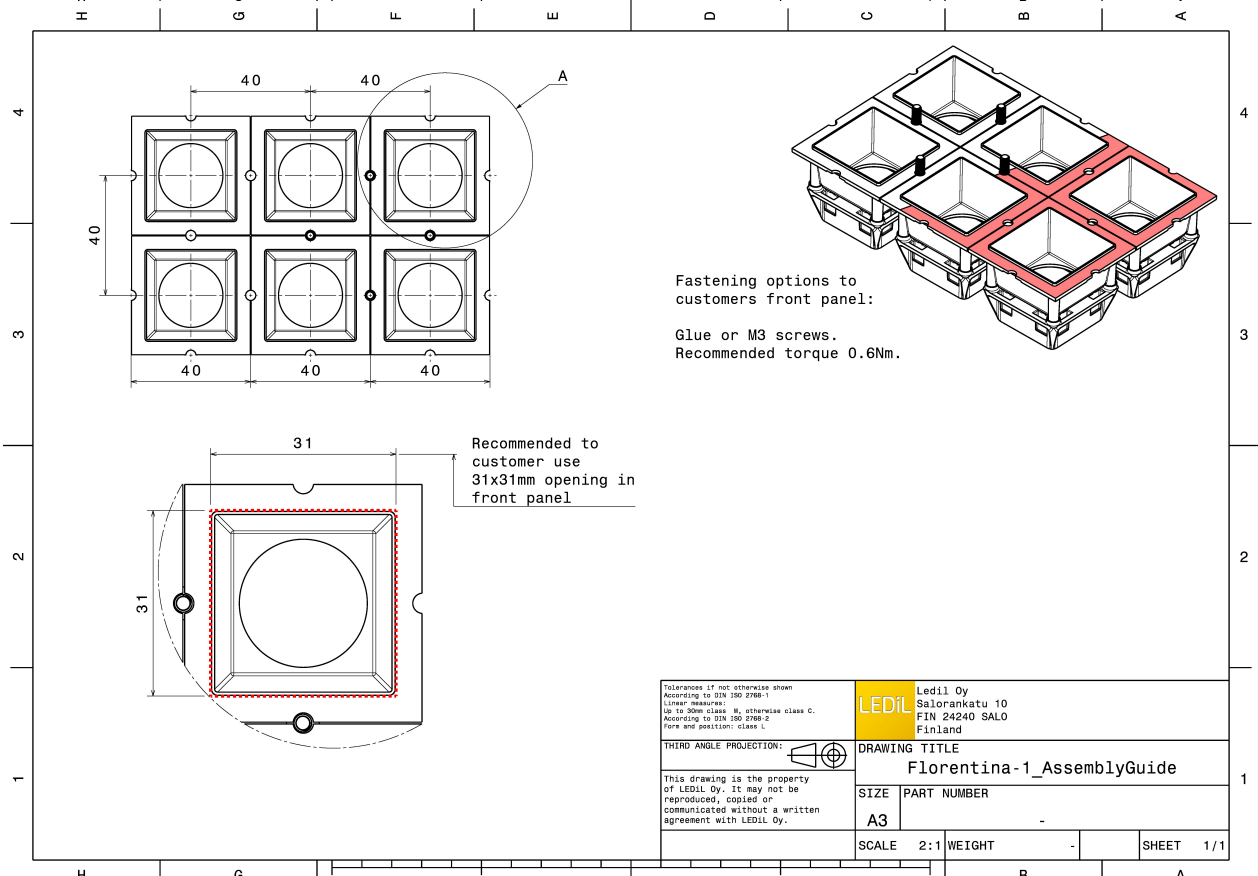
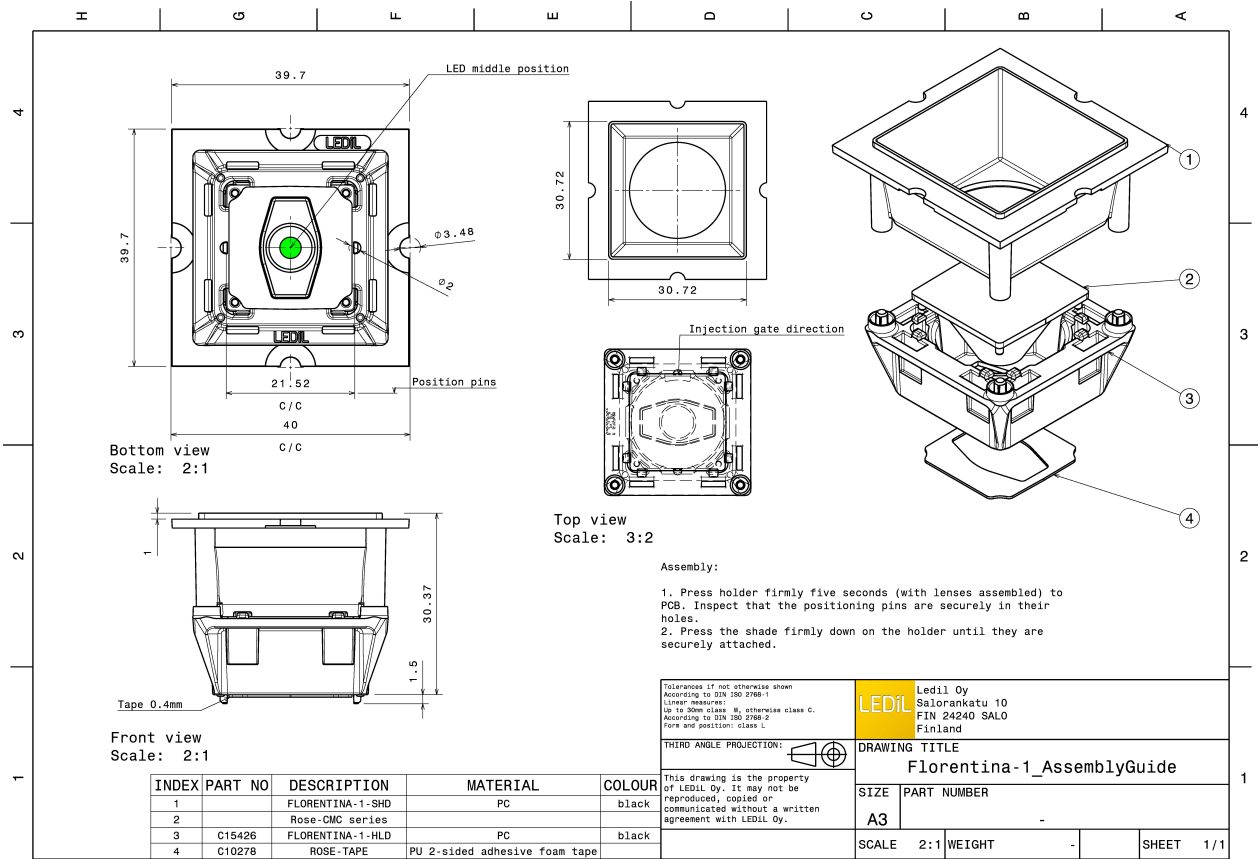

ORDERING INFORMATION:

Component		Qty in box	MOQ	MPQ	Box weight (kg)
FCA15452_FLORENTINA-1-O	Single lens	840		60	7.9
» Box size: 480 x 280 x 300 mm					

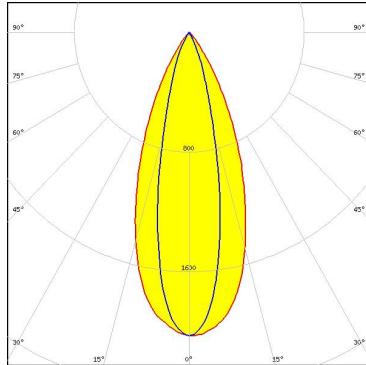
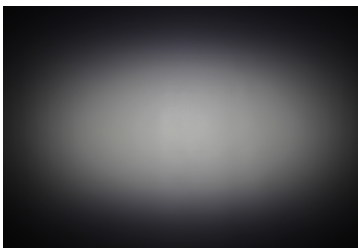
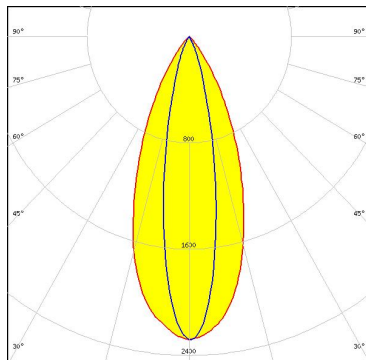

PHOTOMETRIC DATA (MEASURED):

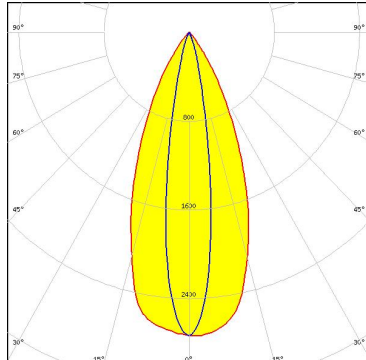
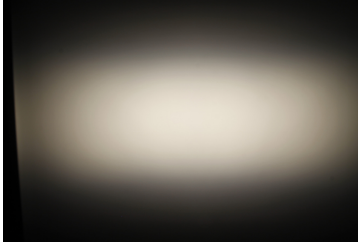
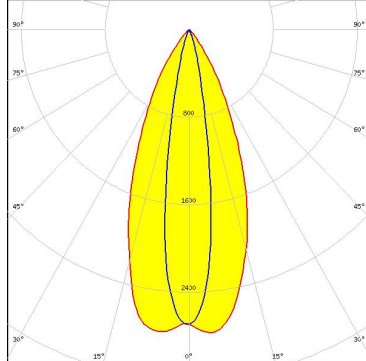
<p>bridgelux</p> <p>LED Bridgelux SMD 5050 FWHM 42.0 + 24.0° Efficiency 71 % Peak intensity 2 cd/lm LEDs/each optic 1 Light colour White Required components: C15427_FLORENTINA-1-SHD-60</p>		
<p>CREE</p> <p>LED XHP35 HD FWHM 42.0 + 21.0° Efficiency 71 % Peak intensity 2.3 cd/lm LEDs/each optic 1 Light colour White Required components: C15427_FLORENTINA-1-SHD-60</p>		
<p>CREE</p> <p>LED XHP35 HI FWHM 28.0° Efficiency 72 % Peak intensity 2.7 cd/lm LEDs/each optic 1 Light colour White Required components:</p>		
<p>CREE</p> <p>LED XP-G2 FWHM 44.0 + 18.0° Efficiency 73 % Peak intensity 2.8 cd/lm LEDs/each optic 1 Light colour White Required components: C15427_FLORENTINA-1-SHD-60</p>		

PHOTOMETRIC DATA (MEASURED):



LED XP-L HD
 FWHM 43.0 + 19.0°
 Efficiency 71 %
 Peak intensity 2.4 cd/lm
 LEDs/each optic 1
 Light colour White
 Required components:
 C15427_FLORENTINA-1-SHD-60

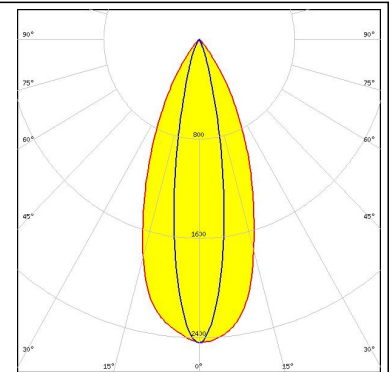
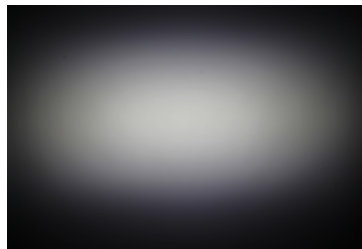

LED XP-L2
 FWHM 43.0 + 20.0°
 Efficiency 69 %
 Peak intensity 2.3 cd/lm
 LEDs/each optic 1
 Light colour White
 Required components:
 C15427_FLORENTINA-1-SHD-60

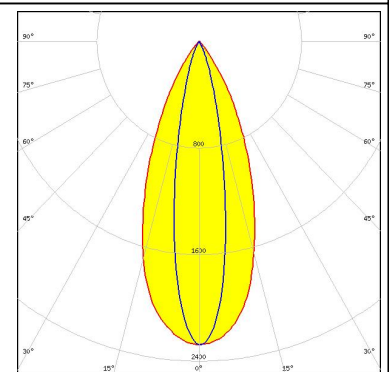
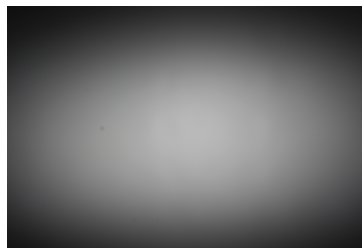

LED XT-E
 FWHM 44.0 + 16.0°
 Efficiency 71 %
 Peak intensity 2.9 cd/lm
 LEDs/each optic 1
 Light colour White
 Required components:
 C15427_FLORENTINA-1-SHD-60

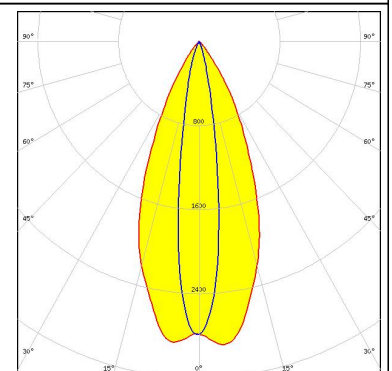
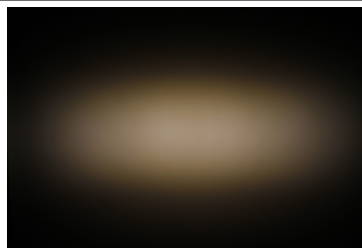

LED LG 5630
 FWHM 45.0 + 17.0°
 Efficiency 77 %
 Peak intensity 2.9 cd/lm
 LEDs/each optic 1
 Light colour White
 Required components:
 C16701_FLORENTINA-1-SHD-60-WHT

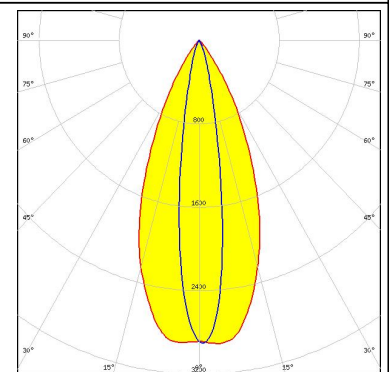
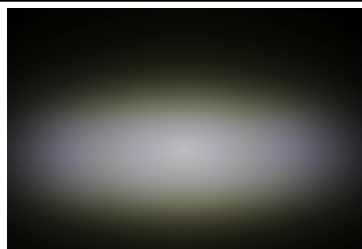

PHOTOMETRIC DATA (MEASURED):

LG Innotek

LED LG 5630
 FWHM 45.0 + 16.0°
 Efficiency 75 %
 Peak intensity 2.9 cd/lm
 LEDs/each optic 1
 Light colour White
 Required components:
 C15427_FLORENTINA-1-SHD-60

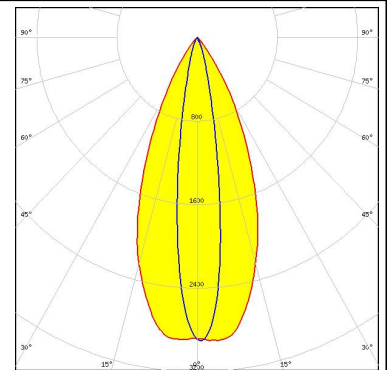

LUMILEDS

LED LUXEON 3030 2D (Round LES)
 FWHM 45.0 + 14.0°
 Efficiency 75 %
 Peak intensity 3.4 cd/lm
 LEDs/each optic 1
 Light colour White
 Required components:

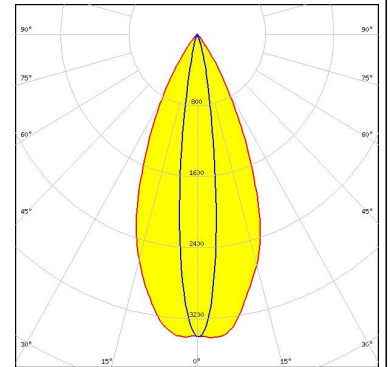
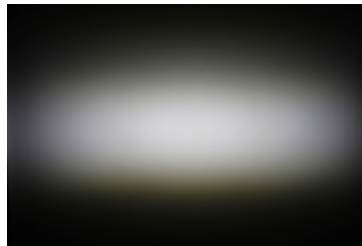

LUMILEDS

LED LUXEON 5050 Round LES
 FWHM 42.0 + 22.0°
 Efficiency 72 %
 Peak intensity 2.2 cd/lm
 LEDs/each optic 1
 Light colour White
 Required components:
 C15427_FLORENTINA-1-SHD-60

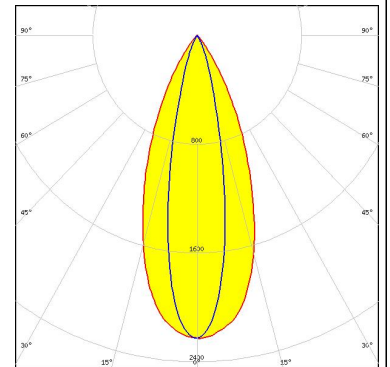
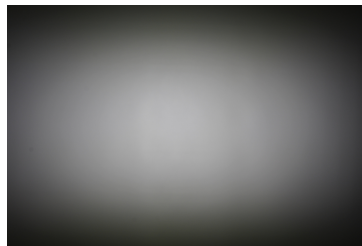

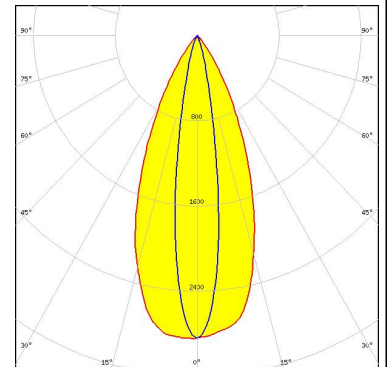
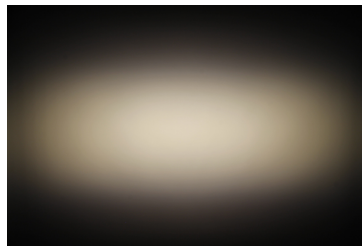

LUMILEDS

LED LUXEON TX
 FWHM 44.0 + 17.0°
 Efficiency 72 %
 Peak intensity 2.8 cd/lm
 LEDs/each optic 1
 Light colour White
 Required components:
 C15427_FLORENTINA-1-SHD-60

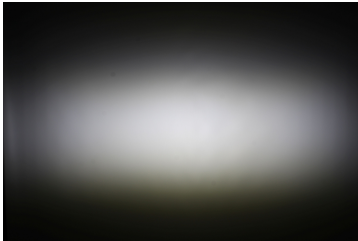
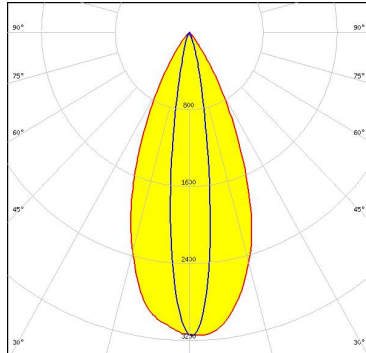
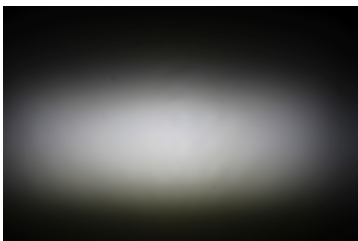
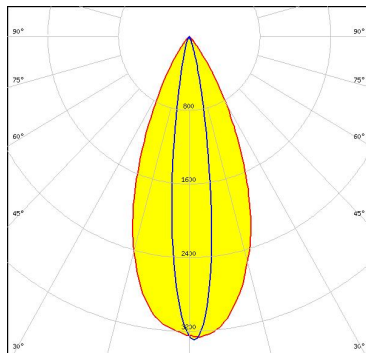
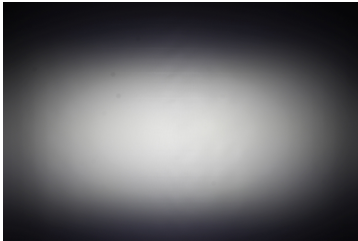
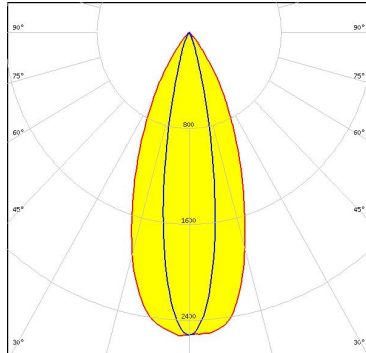

PHOTOMETRIC DATA (MEASURED):

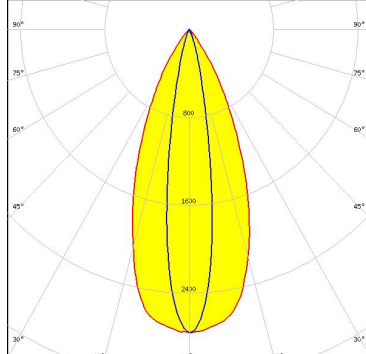
<p>NICHIA</p> <p>LED NF2x757G FWHM 45.0 + 15.0° Efficiency 75 % Peak intensity 3.2 cd/lm LEDs/each optic 1 Light colour White Required components: C16701_FLORENTINA-1-SHD-60-WHT</p>		
<p>NICHIA</p> <p>LED NF2x757G FWHM 44.0 + 15.0° Efficiency 76 % Peak intensity 3.3 cd/lm LEDs/each optic 1 Light colour White Required components: C15427_FLORENTINA-1-SHD-60</p>		
<p>NICHIA</p> <p>LED NVSW319B FWHM 43.0 + 20.0° Efficiency 74 % Peak intensity 2.5 cd/lm LEDs/each optic 1 Light colour White Required components: C15427_FLORENTINA-1-SHD-60</p>		
<p>NICHIA</p> <p>LED NVSxx19B/NVSxx19C FWHM 44.0 + 17.0° Efficiency 72 % Peak intensity 2.8 cd/lm LEDs/each optic 1 Light colour White Required components: C15427_FLORENTINA-1-SHD-60</p>		

PHOTOMETRIC DATA (MEASURED):

OSRAM

Opto Semiconductors

LED OSLOM Square CSSRM2/CSSRM3
 FWHM 44.0 + 17.0°
 Efficiency 74 %
 Peak intensity 2.9 cd/lm
 LEDs/each optic 1
 Light colour White
 Required components:
 C15427_FLORENTINA-1-SHD-60

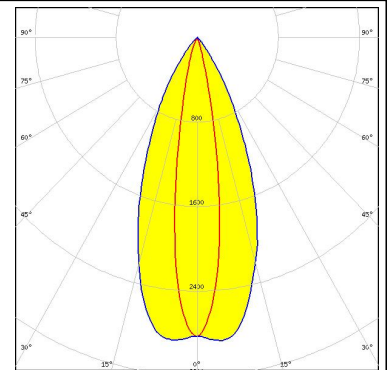

OSRAM

Opto Semiconductors

LED OSLOM SSL 150
 FWHM 45.0 + 15.0°
 Efficiency 72 %
 Peak intensity 3.3 cd/lm
 LEDs/each optic 1
 Light colour White
 Required components:
 C15427_FLORENTINA-1-SHD-60

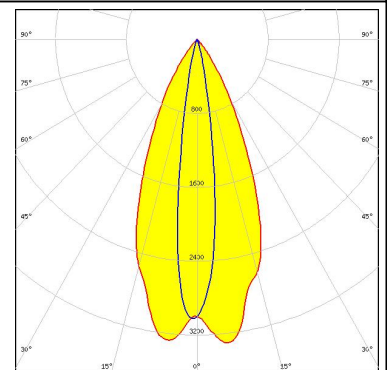
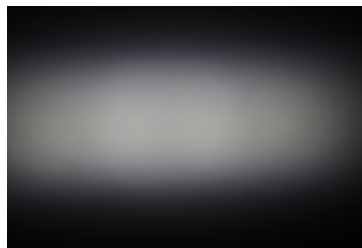

SAMSUNG

LED LM561B
 FWHM 45.0 + 15.0°
 Efficiency 75 %
 Peak intensity 3.1 cd/lm
 LEDs/each optic 1
 Light colour White
 Required components:
 C15427_FLORENTINA-1-SHD-60

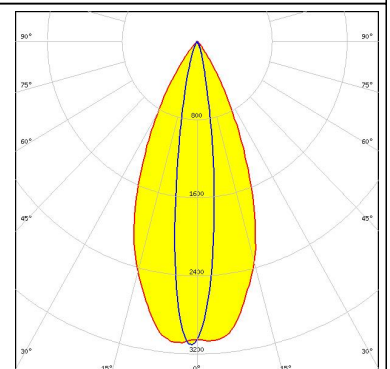
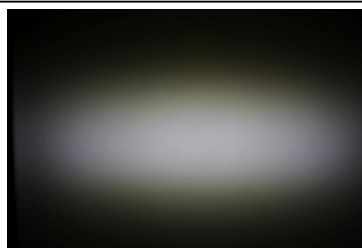

SEOUL SEMICONDUCTOR

LED SEOUL 5630
 FWHM 45.0 + 15.0°
 Efficiency 77 %
 Peak intensity 3.4 cd/lm
 LEDs/each optic 1
 Light colour White
 Required components:
 C15427_FLORENTINA-1-SHD-60

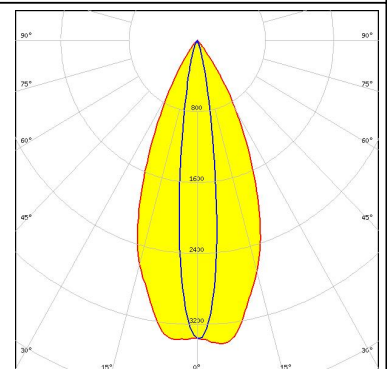
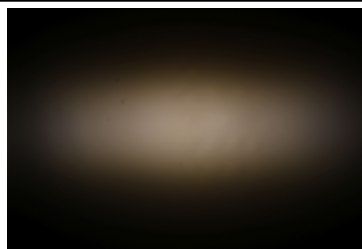

PHOTOMETRIC DATA (MEASURED):

			
SEOUL SEMICONDUCTOR			
LED	Z8Y22P		
FWHM	44.0 + 17.0°		
Efficiency	69 %		
Peak intensity	2.7 cd/lm		
LEDs/each optic	1		
Light colour	White		
Required components:			
	C15427_FLORENTINA-1-SHD-60		

PHOTOMETRIC DATA (SIMULATED):



LED XP-G2 HE
FWHM 42.0 + 22.0°
Efficiency 82 %
Peak intensity 2.5 cd/lm
LEDs/each optic 1
Light colour White
Required components:
C15427_FLORENTINA-1-SHD-60

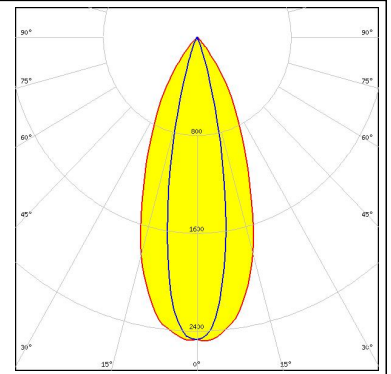

GENERAL INFORMATION:

NOTE: The typical beam angle will be changed by different color, chip size and chip position tolerance. The typical total beam angle is the full angle measured where the luminous intensity is half of the peak value.

MATERIALS:

As part of our continuous research and improvement processes, and to ensure the best possible quality and availability of our products, LEDiL reserves the right to change material grades without notice.

PRODUCT DATA USER AGREEMENT AND DISCLAIMER:

The measured data in the provided downloadable LEDiL Product Datasheets and Mechanical 2D-Drawings is rounded and provided as reference for planning. LEDiL Oy's optical specifications have been verified by conducting performance testing of the products in accordance with the company's quality system. The reported data are averaged results of multiple measurements with typical variation. LEDiL Oy reserves the right to without prior notification make changes and improvements to its products.

LEDiL Oy assumes neither warranty, nor guarantee nor any other liability of any kind for the contents and correctness of the provided data. The provided data has been generated with highest diligence but the provided data may in reality not represent the complete possible variation range of all intrinsic parameters. Therefore, in certain cases a deviation from the provided data could occur.

LEDiL Oy reserves the right to undertake technical changes of its products without further notification which could lead to changes in the provided data. LEDiL Oy assumes no liability of any kind for the possible deviation from any provided data or any other damage resulting from the usage of the provided data.

The user agrees to this disclaimer and user agreement with the download or usage of the provided files.

LEDiL Oy

Joensuunkatu 13
FI-24240 SALO
Finland

LEDiL Inc.

228 West Page Street
Suite D
Sycamore IL 60178
USA

Local sales and technical support

[www.ledil.com/
where_to_buy](http://www.ledil.com/where_to_buy)

Shipping locations

Salo, Finland
Hong Kong, China

Distribution Partners

[www.ledil.com/
where_to_buy](http://www.ledil.com/where_to_buy)

Компания «Life Electronics» занимается поставками электронных компонентов импортного и отечественного производства от производителей и со складов крупных дистрибьюторов Европы, Америки и Азии.

С конца 2013 года компания активно расширяет линейку поставок компонентов по направлению коаксиальный кабель, кварцевые генераторы и конденсаторы (керамические, пленочные, электролитические), за счёт заключения дистрибьюторских договоров

Мы предлагаем:

- Конкуренеспособные цены и скидки постоянным клиентам.
- Специальные условия для постоянных клиентов.
- Подбор аналогов.
- Поставку компонентов в любых объемах, удовлетворяющих вашим потребностям.
- Приемлемые сроки поставки, возможна ускоренная поставка.
- Доставку товара в любую точку России и стран СНГ.
- Комплексную поставку.
- Работу по проектам и поставку образцов.
- Формирование склада под заказчика.
- Сертификаты соответствия на поставляемую продукцию (по желанию клиента).
- Тестирование поставляемой продукции.
- Поставку компонентов, требующих военную и космическую приемку.
- Входной контроль качества.
- Наличие сертификата ISO.

В составе нашей компании организован Конструкторский отдел, призванный помогать разработчикам, и инженерам.

Конструкторский отдел помогает осуществить:

- Регистрацию проекта у производителя компонентов.
- Техническую поддержку проекта.
- Защиту от снятия компонента с производства.
- Оценку стоимости проекта по компонентам.
- Изготовление тестовой платы монтаж и пусконаладочные работы.



Тел: +7 (812) 336 43 04 (многоканальный)

Email: org@lifeelectronics.ru