

## High-Voltage Trench MOS Barrier Schottky Rectifier

Ultra Low  $V_F = 0.50\text{ V}$  at  $I_F = 5\text{ A}$

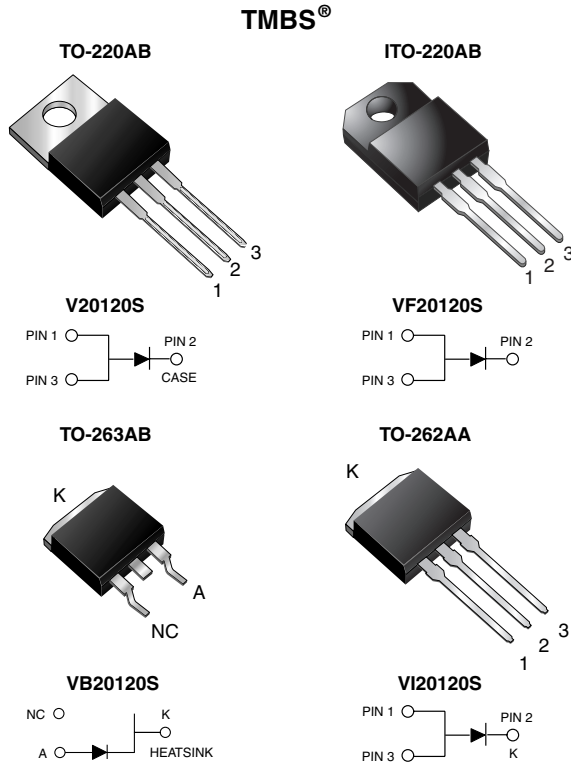

### FEATURES

- Trench MOS Schottky technology
- Low forward voltage drop, low power losses
- High efficiency operation
- Meets MSL level 1, per J-STD-020, LF maximum peak of 245 °C (for TO-263AB package)
- Solder bath temperature 275 °C maximum, 10 s, per JESD 22-B106 (for TO-220AB, ITO-220AB, and TO-262AA package)
- Compliant to RoHS directive 2002/95/EC and in accordance to WEEE 2002/96/EC



**RoHS**  
COMPLIANT

### TYPICAL APPLICATIONS

For use in high frequency converters, switching power supplies, freewheeling diodes, OR-ing diode, dc-to-dc converters and reverse battery protection.

### MECHANICAL DATA

**Case:** TO-220AB, ITO-220AB, TO-263AB and TO-262AA

Molding compound meets UL 94 V-0 flammability rating

Base P/N-E3 - RoHS compliant, commercial grade

**Terminals:** Matte tin plated leads, solderable per J-STD-002 and JESD 22-B102

E3 suffix meets JESD 201 class 1A whisker test

**Polarity:** As marked

**Mounting Torque:** 10 in-lbs maximum

### PRIMARY CHARACTERISTICS

|                              |        |
|------------------------------|--------|
| $I_{F(AV)}$                  | 20 A   |
| $V_{RRM}$                    | 120 V  |
| $I_{FSM}$                    | 200 A  |
| $V_F$ at $I_F = 20\text{ A}$ | 0.73 V |
| $T_J$ max.                   | 150 °C |

### MAXIMUM RATINGS ( $T_A = 25\text{ °C}$ unless otherwise noted)

| PARAMETER   | SYMBOL         | V20120S       | VF20120S | VB20120S | VI20120S | UNIT             |
|---|----------------|---------------|----------|----------|----------|------------------|
| Maximum repetitive peak reverse voltage   | $V_{RRM}$      | 120           |          |          |          | V                |
| Maximum average forward rectified current (fig. 1)  | $I_{F(AV)}$    | 20            |          |          |          | A                |
| Peak forward surge current 8.3 ms single half sine-wave superimposed on rated load                            | $I_{FSM}$      | 200           |          |          |          | A                |
| Non-repetitive avalanche energy at $T_J = 25\text{ °C}$ , $L = 60\text{ mH}$                                  | $E_{AS}$       | 130           |          |          |          | mJ               |
| Peak repetitive reverse current at $t_p = 2\text{ }\mu\text{s}$ , 1 kHz, $T_J = 38\text{ °C} \pm 2\text{ °C}$ | $I_{RRM}$      | 0.5           |          |          |          | A                |
| Voltage rate of change (rated $V_R$ )   | dV/dt          | 10 000        |          |          |          | V/ $\mu\text{s}$ |
| Isolation voltage (ITO-220AB only) from terminal to heatsink $t = 1\text{ min}$                               | $V_{AC}$       | 1500          |          |          |          | V                |
| Operating junction and storage temperature range  | $T_J, T_{STG}$ | - 40 to + 150 |          |          |          | °C               |

# V20120S, VF20120S, VB20120S & VI20120S



Vishay General Semiconductor

| ELECTRICAL CHARACTERISTICS (T <sub>A</sub> = 25 °C unless otherwise noted) |  |   |                 |                      |                |          |
|--|--|---|-----------------|----------------------|----------------|----------|
| PARAMETER  | TEST CONDITIONS  |   | SYMBOL          | TYP.                 | MAX.           | UNIT     |
| Breakdown voltage  | I <sub>R</sub> = 1.0 mA  | T <sub>A</sub> = 25 °C                            | V <sub>BR</sub> | 120 (minimum)        | -              | V        |
| Instantaneous forward voltage <sup>(1)</sup>                               | I <sub>F</sub> = 5 A<br>I <sub>F</sub> = 10 A<br>I <sub>F</sub> = 20 A | T <sub>A</sub> = 25 °C                            | V <sub>F</sub>  | 0.57<br>0.71<br>0.99 | -<br>-<br>1.12 |          |
|  | I <sub>F</sub> = 5 A<br>I <sub>F</sub> = 10 A<br>I <sub>F</sub> = 20 A | T <sub>A</sub> = 125 °C                           |                 | 0.50<br>0.61<br>0.73 | -<br>-<br>0.81 |          |
| Reverse current <sup>(2)</sup>   | V <sub>R</sub> = 90 V  | T <sub>A</sub> = 25 °C<br>T <sub>A</sub> = 125 °C | I <sub>R</sub>  | 10<br>6              | -<br>-         |          |
|  | V <sub>R</sub> = 120 V   | T <sub>A</sub> = 25 °C<br>T <sub>A</sub> = 125 °C |                 | -<br>14              | 300<br>30      | μA<br>mA |

**Notes**

<sup>(1)</sup> Pulse test: 300 μs pulse width, 1 % duty cycle

<sup>(2)</sup> Pulse test: Pulse width ≤ 40 ms

| THERMAL CHARACTERISTICS (T <sub>A</sub> = 25 °C unless otherwise noted) |                  |         |          |          |          |      |
|---|------------------|---------|----------|----------|----------|------|
| PARAMETER   | SYMBOL           | V20120S | VF20120S | VB20120S | VI20120S | UNIT |
| Typical thermal resistance  | R <sub>θJC</sub> | 2       | 4        | 2        | 2        | °C/W |

| ORDERING INFORMATION (Example) |                |                 |              |               |               |
|--------------------------------|----------------|-----------------|--------------|---------------|---------------|
| PACKAGE                        | PREFERRED P/N  | UNIT WEIGHT (g) | PACKAGE CODE | BASE QUANTITY | DELIVERY MODE |
| TO-220AB                       | V20120S-E3/4W  | 1.88            | 4W           | 50/tube       | Tube          |
| ITO-220AB                      | VF20120S-E3/4W | 1.75            | 4W           | 50/tube       | Tube          |
| TO-263AB                       | VB20120S-E3/4W | 1.38            | 4W           | 50/tube       | Tube          |
| TO-263AB                       | VB20120S-E3/8W | 1.38            | 8W           | 800/reel      | Tape and reel |
| TO-262AA                       | VI20120S-E3/4W | 1.45            | 4W           | 50/tube       | Tube          |

## RATINGS AND CHARACTERISTICS CURVES

(T<sub>A</sub> = 25 °C unless otherwise noted)

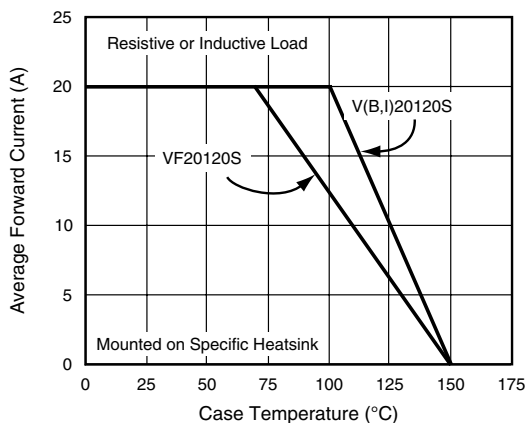

Figure 1. Maximum Forward Current Derating Curve

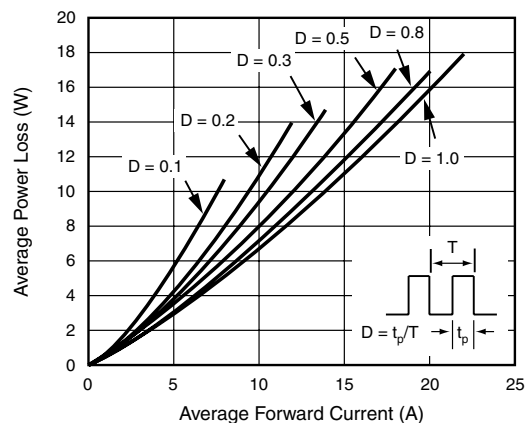

Figure 2. Forward Power Loss Characteristics

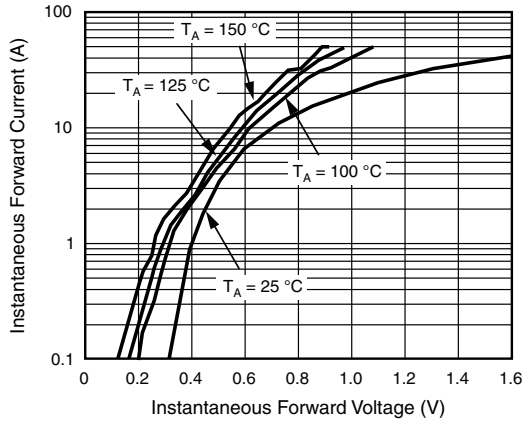

Figure 3. Typical Instantaneous Forward Characteristics

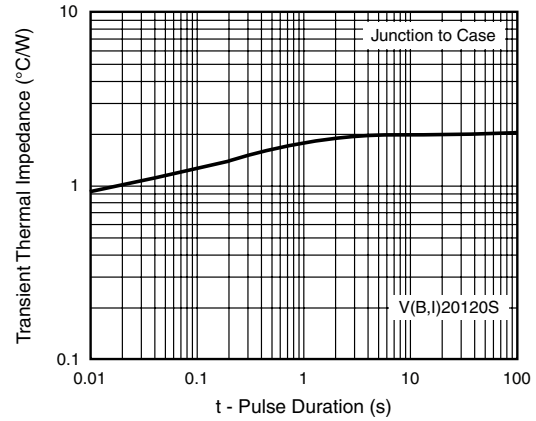

Figure 6. Typical Transient Thermal Impedance

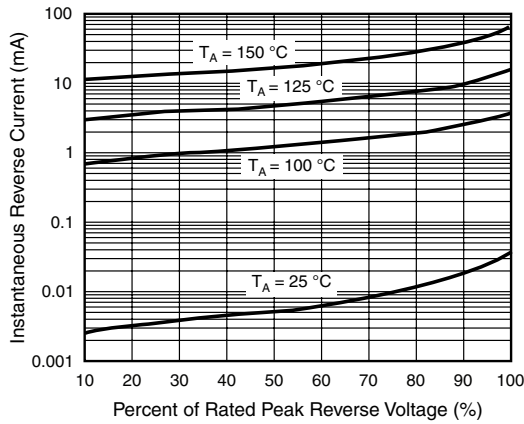

Figure 4. Typical Reverse Characteristics

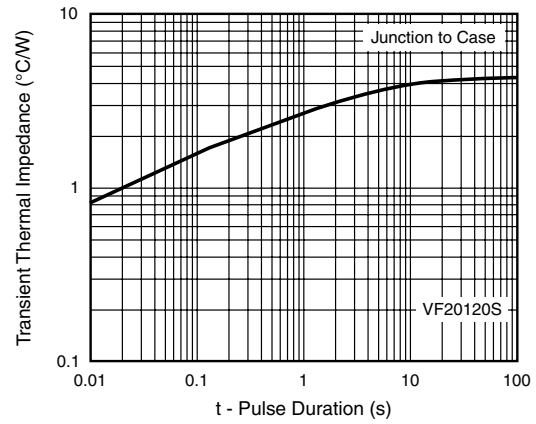

Figure 7. Typical Transient Thermal Impedance

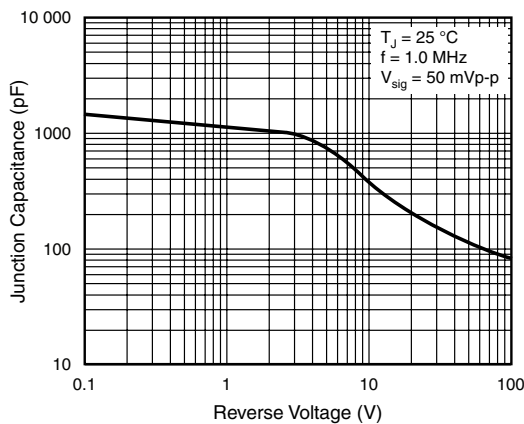

Figure 5. Typical Junction Capacitance

# V20120S, VF20120S, VB20120S & VI20120S

Vishay General Semiconductor



## PACKAGE OUTLINE DIMENSIONS in inches (millimeters)

TO-220AB

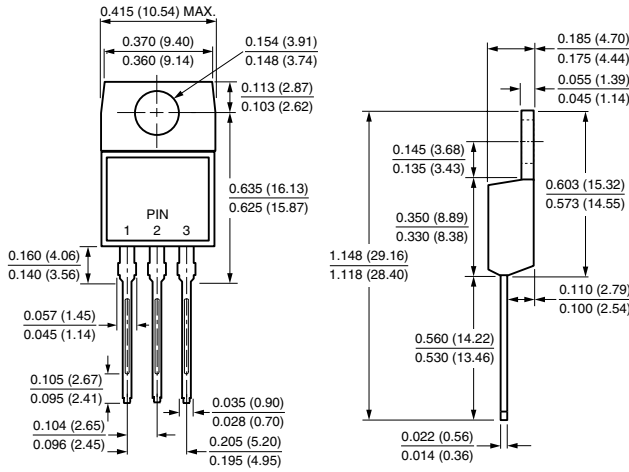

ITO-220AB



TO-262AA

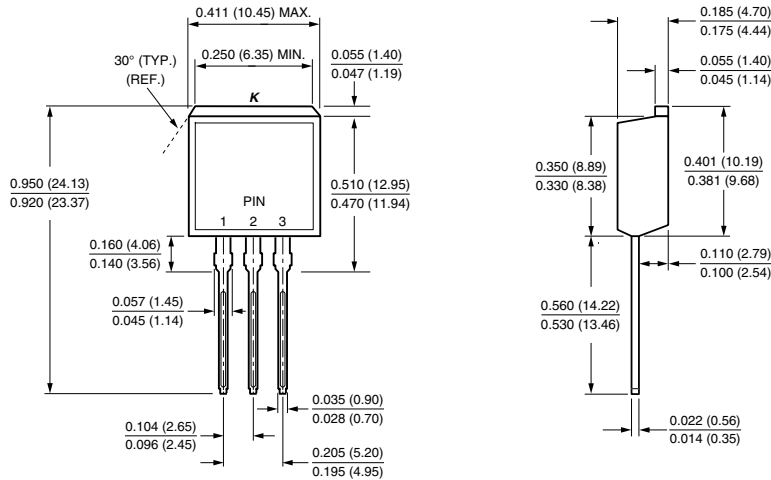

TO-263AB

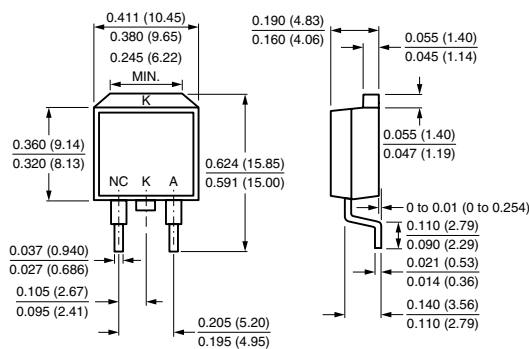

Mounting Pad Layout

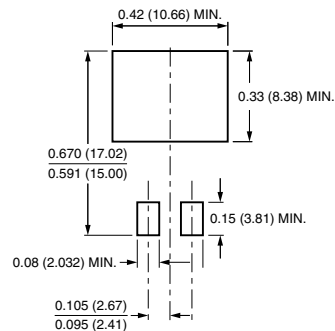



## Disclaimer

ALL PRODUCT, PRODUCT SPECIFICATIONS AND DATA ARE SUBJECT TO CHANGE WITHOUT NOTICE TO IMPROVE RELIABILITY, FUNCTION OR DESIGN OR OTHERWISE.

Vishay Intertechnology, Inc., its affiliates, agents, and employees, and all persons acting on its or their behalf (collectively, "Vishay"), disclaim any and all liability for any errors, inaccuracies or incompleteness contained in any datasheet or in any other disclosure relating to any product.

Vishay makes no warranty, representation or guarantee regarding the suitability of the products for any particular purpose or the continuing production of any product. To the maximum extent permitted by applicable law, Vishay disclaims (i) any and all liability arising out of the application or use of any product, (ii) any and all liability, including without limitation special, consequential or incidental damages, and (iii) any and all implied warranties, including warranties of fitness for particular purpose, non-infringement and merchantability.

Statements regarding the suitability of products for certain types of applications are based on Vishay's knowledge of typical requirements that are often placed on Vishay products in generic applications. Such statements are not binding statements about the suitability of products for a particular application. It is the customer's responsibility to validate that a particular product with the properties described in the product specification is suitable for use in a particular application. Parameters provided in datasheets and/or specifications may vary in different applications and performance may vary over time. All operating parameters, including typical parameters, must be validated for each customer application by the customer's technical experts. Product specifications do not expand or otherwise modify Vishay's terms and conditions of purchase, including but not limited to the warranty expressed therein.

Except as expressly indicated in writing, Vishay products are not designed for use in medical, life-saving, or life-sustaining applications or for any other application in which the failure of the Vishay product could result in personal injury or death. Customers using or selling Vishay products not expressly indicated for use in such applications do so at their own risk and agree to fully indemnify and hold Vishay and its distributors harmless from and against any and all claims, liabilities, expenses and damages arising or resulting in connection with such use or sale, including attorneys fees, even if such claim alleges that Vishay or its distributor was negligent regarding the design or manufacture of the part. Please contact authorized Vishay personnel to obtain written terms and conditions regarding products designed for such applications.

No license, express or implied, by estoppel or otherwise, to any intellectual property rights is granted by this document or by any conduct of Vishay. Product names and markings noted herein may be trademarks of their respective owners.

## Material Category Policy

**Vishay Intertechnology, Inc. hereby certifies that all its products that are identified as RoHS-Compliant fulfill the definitions and restrictions defined under Directive 2011/65/EU of The European Parliament and of the Council of June 8, 2011 on the restriction of the use of certain hazardous substances in electrical and electronic equipment (EEE) - recast, unless otherwise specified as non-compliant.**

**Please note that some Vishay documentation may still make reference to RoHS Directive 2002/95/EC. We confirm that all the products identified as being compliant to Directive 2002/95/EC conform to Directive 2011/65/EU.**

Компания «Life Electronics» занимается поставками электронных компонентов импортного и отечественного производства от производителей и со складов крупных дистрибьюторов Европы, Америки и Азии.

С конца 2013 года компания активно расширяет линейку поставок компонентов по направлению коаксиальный кабель, кварцевые генераторы и конденсаторы (керамические, пленочные, электролитические), за счёт заключения дистрибьюторских договоров

Мы предлагаем:

- Конкурентоспособные цены и скидки постоянным клиентам.
- Специальные условия для постоянных клиентов.
- Подбор аналогов.
- Поставку компонентов в любых объемах, удовлетворяющих вашим потребностям.
- Приемлемые сроки поставки, возможна ускоренная поставка.
- Доставку товара в любую точку России и стран СНГ.
- Комплексную поставку.
- Работу по проектам и поставку образцов.
- Формирование склада под заказчика.
- Сертификаты соответствия на поставляемую продукцию (по желанию клиента).
- Тестирование поставляемой продукции.
- Поставку компонентов, требующих военную и космическую приемку.
- Входной контроль качества.
- Наличие сертификата ISO.

В составе нашей компании организован Конструкторский отдел, призванный помогать разработчикам, и инженерам.

Конструкторский отдел помогает осуществить:

- Регистрацию проекта у производителя компонентов.
- Техническую поддержку проекта.
- Защиту от снятия компонента с производства.
- Оценку стоимости проекта по компонентам.
- Изготовление тестовой платы монтаж и пусконаладочные работы.



Тел: +7 (812) 336 43 04 (многоканальный)

Email: [org@lifeelectronics.ru](mailto:org@lifeelectronics.ru)