



SANYO Semiconductors

# DATA SHEET

An ON Semiconductor Company

## 55GN01FA — NPN Epitaxial Planar Silicon Transistor UHF Wide-band Low-noise Amplifier Applications

### Features

- High cut-off frequency :  $f_T=5.5\text{GHz}$  typ
- High gain :  $|S_{21e}|^2=11\text{dB}$  typ ( $f=1\text{GHz}$ )  
=19dB typ ( $f=400\text{MHz}$ )
- Ultrasmall package permitting applied sets to be small and slim
- Halogen free compliance

### Specifications

#### Absolute Maximum Ratings at $T_a=25^\circ\text{C}$

Parameter	Symbol	Conditions	Ratings	Unit
Collector-to-Base Voltage	$V_{CB0}$		20	V
Collector-to-Emitter Voltage	$V_{CEO}$		10	V
Emitter-to-Base Voltage	$V_{EBO}$		3	V
Collector Current	$I_C$		70	mA
Collector Dissipation	$P_C$		250	mW
Junction Temperature	$T_j$		150	$^\circ\text{C}$
Storage Temperature	$T_{stg}$		-55 to +150	$^\circ\text{C}$

### Package Dimensions

unit : mm (typ)

7029A-002

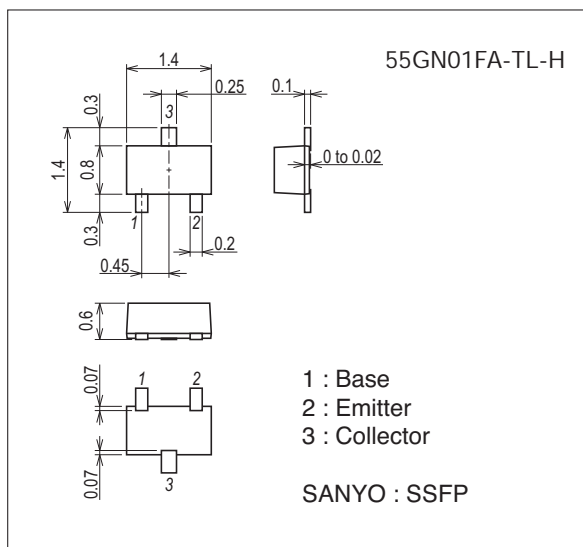

### Product & Package Information

- Package : SSFP
- JEITA, JEDEC : SC-81
- Minimum Packing Quantity : 8,000 pcs./reel

### Packing Type: TL

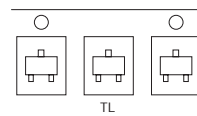

### Marking

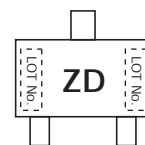

### Electrical Connection

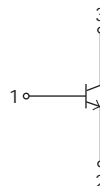

# 55GN01FA

## Electrical Characteristics at Ta=25°C

Parameter	Symbol	Conditions	Ratings			Unit
			min	typ	max	
Collector Cutoff Current	$I_{CBO}$	$V_{CB}=10V, I_E=0A$			0.1	$\mu A$
Emitter Cutoff Current	$I_{EBO}$	$V_{EB}=2V, I_C=0A$			1	$\mu A$
DC Current Gain	$h_{FE}$	$V_{CE}=5V, I_C=10mA$	100		160	
Gain-Bandwidth Product	$f_T1$	$V_{CE}=3V, I_C=5mA$	3.0	4.5		GHz
	$f_T2$	$V_{CE}=5V, I_C=20mA$		5.5		GHz
Output Capacitance	$C_{ob}$	$V_{CB}=10V, f=1MHz$		0.95	1.2	pF
Reverse Transfer Capacitance	$C_{re}$				0.6	pF
Forward Transfer Gain	$ S_{21e} ^21$	$V_{CE}=5V, I_C=20mA, f=1GHz$	8	11		dB
	$ S_{21e} ^22$	$V_{CE}=5V, I_C=20mA, f=400MHz$	16	19		dB
Noise Figure	NF	$V_{CE}=3V, I_C=5mA, f=1GHz, Z_S=Z_L=50\Omega$		1.9		dB

## Ordering Information

Device	Package	Shipping	memo
55GN01FA-TL-H	SSFP	8,000pcs./reel	Pb Free and Halogen Free

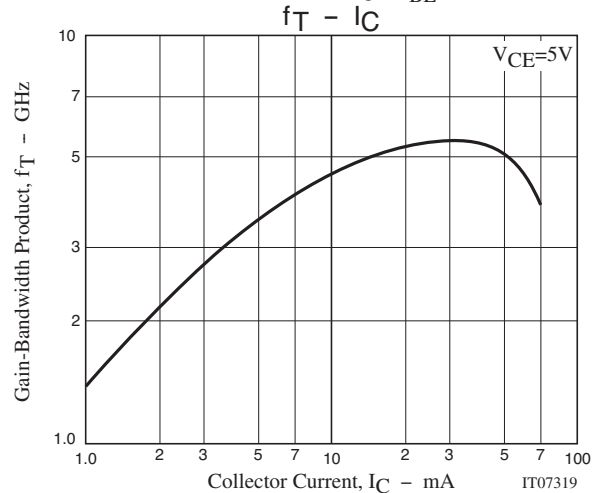
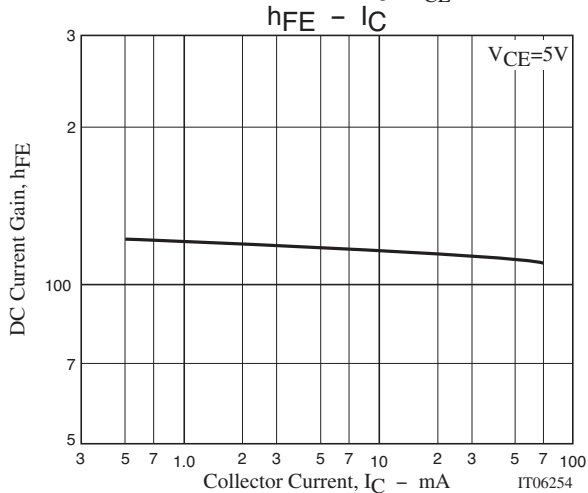
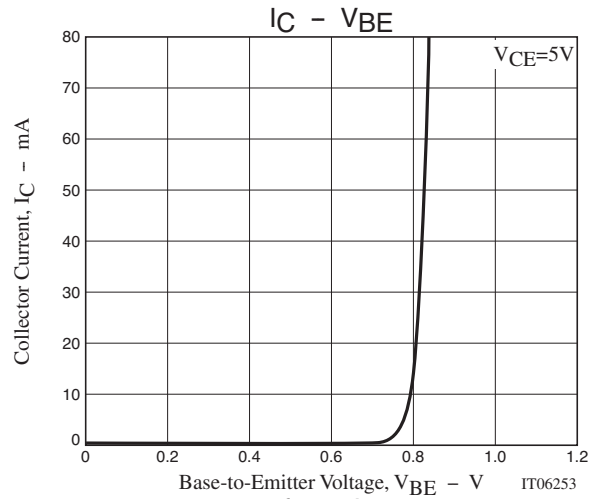
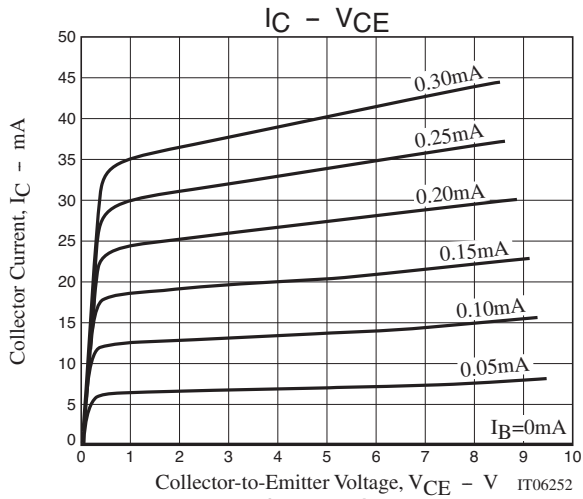

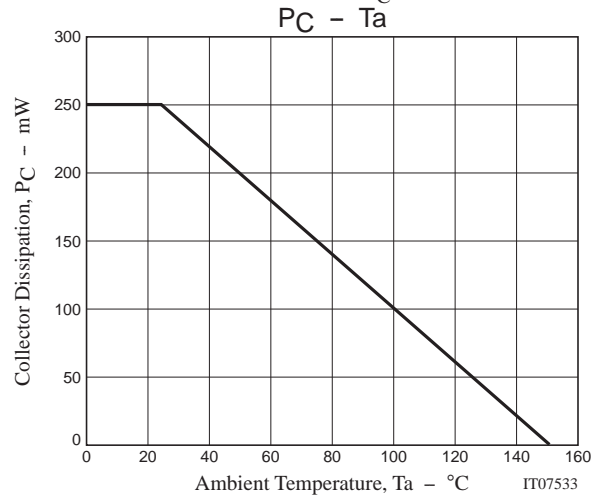
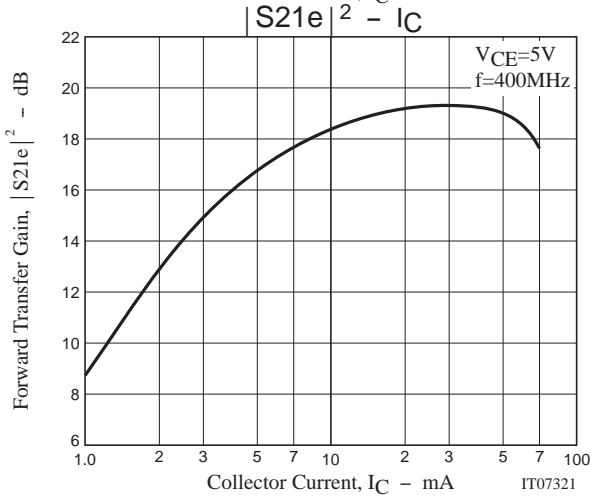
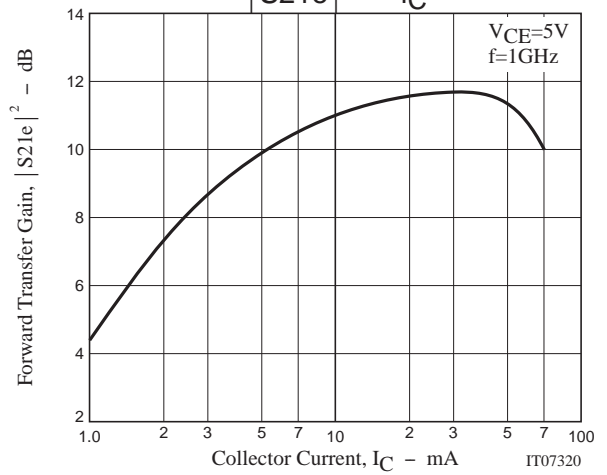
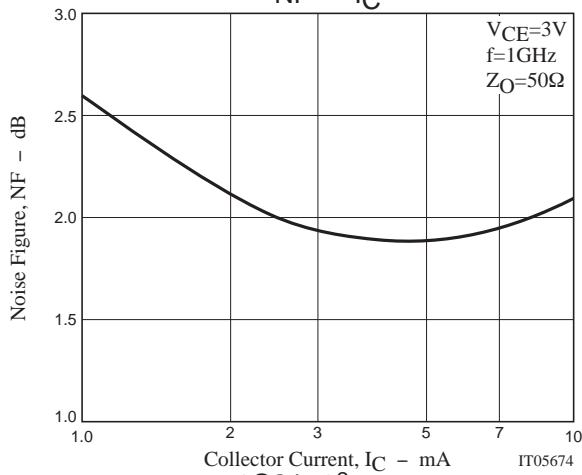
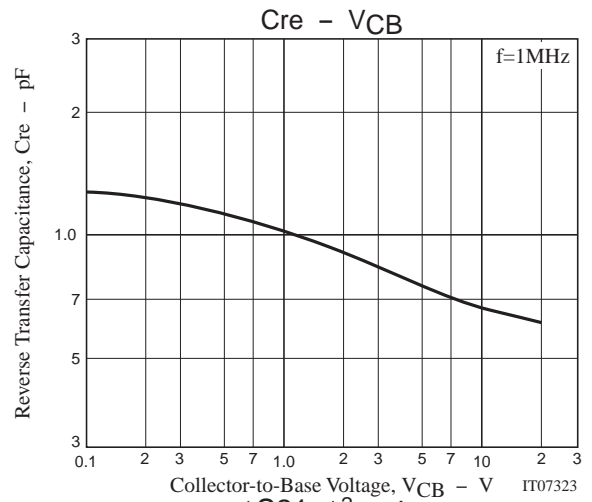
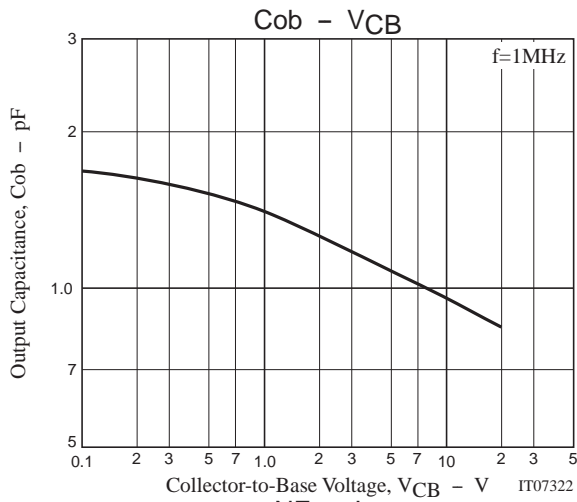

## 55GN01FA

### S Parameters (Common emitter)

$V_{CE}=5V, I_C=1mA, Z_O=50\Omega$

Freq(MHz)	S11	$\angle S11$	S21	$\angle S21$	S12	$\angle S12$	S22	$\angle S22$
100	0.960	-21.33	3.404	164.99	0.046	77.57	0.986	-9.38
200	0.943	-40.21	3.215	151.43	0.085	64.91	0.938	-18.56
400	0.888	-72.87	2.700	128.23	0.139	46.91	0.838	-31.44
600	0.853	-97.36	2.288	110.64	0.167	34.66	0.757	-40.30
800	0.816	-115.67	1.926	96.26	0.179	26.17	0.706	-46.95
1000	0.788	-129.19	1.659	84.81	0.180	19.95	0.676	-52.20
1200	0.767	-140.35	1.451	74.89	0.174	16.50	0.664	-56.92
1400	0.749	-149.12	1.286	66.48	0.168	14.89	0.662	-61.86
1600	0.734	-156.38	1.162	59.19	0.160	14.19	0.668	-66.10
1800	0.719	-163.17	1.061	52.60	0.149	15.77	0.677	-70.98
2000	0.705	-169.31	0.977	46.28	0.141	19.10	0.683	-75.24
2200	0.694	-174.71	0.893	41.12	0.136	24.16	0.695	-79.81
2400	0.683	-179.60	0.825	36.38	0.135	30.74	0.705	-84.33
2600	0.675	-174.53	0.765	32.38	0.141	38.01	0.717	-88.85
2800	0.664	-169.68	0.709	29.26	0.149	45.42	0.729	-93.41
3000	0.653	-165.11	0.667	26.87	0.163	51.07	0.737	-97.77

$V_{CE}=5V, I_C=3mA, Z_O=50\Omega$

Freq(MHz)	S11	$\angle S11$	S21	$\angle S21$	S12	$\angle S12$	S22	$\angle S22$
100	0.897	-35.17	8.858	157.25	0.044	71.22	0.940	-17.73
200	0.846	-64.07	7.795	138.86	0.073	55.30	0.816	-31.57
400	0.761	-104.22	5.532	114.15	0.100	39.30	0.626	-45.72
600	0.727	-127.47	4.177	99.10	0.110	33.80	0.530	-52.62
800	0.698	-142.65	3.306	87.99	0.115	31.00	0.483	-57.50
1000	0.681	-152.69	2.715	79.36	0.120	30.86	0.461	-61.55
1200	0.670	-160.54	2.308	72.11	0.121	33.53	0.456	-65.03
1400	0.656	-166.79	2.012	65.45	0.124	35.60	0.461	-69.34
1600	0.647	-172.10	1.793	59.66	0.130	38.30	0.468	-72.55
1800	0.635	-176.87	1.621	54.21	0.135	41.86	0.479	-76.57
2000	0.628	-178.54	1.481	48.73	0.144	45.68	0.490	-80.11
2200	0.616	-173.99	1.351	44.05	0.153	48.13	0.501	-83.71
2400	0.611	-169.80	1.246	39.67	0.167	50.77	0.518	-87.42
2600	0.601	-166.00	1.157	35.62	0.178	53.54	0.528	-91.49
2800	0.597	-162.06	1.079	32.28	0.196	55.92	0.543	-95.09
3000	0.588	-158.02	1.015	29.15	0.215	56.86	0.555	-98.59

$V_{CE}=5V, I_C=5mA, Z_O=50\Omega$

Freq(MHz)	S11	$\angle S11$	S21	$\angle S21$	S12	$\angle S12$	S22	$\angle S22$
100	0.842	-46.44	13.174	151.15	0.040	64.28	0.891	-24.16
200	0.777	-81.34	10.723	130.44	0.062	50.01	0.716	-39.59
400	0.699	-121.57	6.861	106.89	0.080	39.73	0.508	-52.96
600	0.679	-141.39	4.942	94.02	0.089	37.45	0.424	-58.67
800	0.661	-153.84	3.830	84.43	0.096	38.27	0.390	-62.90
1000	0.648	-162.04	3.117	77.09	0.103	40.59	0.376	-66.27
1200	0.641	-168.02	2.643	70.51	0.111	43.94	0.374	-69.52
1400	0.629	-173.53	2.286	64.60	0.120	46.56	0.382	-73.45
1600	0.620	-177.70	2.039	59.33	0.130	48.48	0.390	-76.69
1800	0.610	-177.97	1.841	54.24	0.139	50.63	0.400	-79.97
2000	0.603	-173.76	1.676	49.26	0.153	53.08	0.413	-83.21
2200	0.594	-169.87	1.528	44.84	0.167	53.92	0.426	-86.71
2400	0.588	-166.14	1.413	40.43	0.181	55.16	0.441	-89.93
2600	0.580	-162.49	1.313	36.57	0.195	56.19	0.453	-93.54
2800	0.576	-158.82	1.231	33.47	0.213	57.85	0.466	-96.88
3000	0.565	-155.09	1.156	30.12	0.232	57.84	0.481	-99.87

# 55GN01FA

## S Parameters (Common emitter)

V<sub>CE</sub>=5V, I<sub>C</sub>=10mA, Z<sub>O</sub>=50Ω

Freq(MHz)	S11	∠S11	S21	∠S21	S12	∠S12	S22	∠S22
100	0.739	-68.53	20.705	140.20	0.033	59.97	0.784	-35.06
200	0.678	-107.92	14.465	118.48	0.048	46.54	0.555	-51.65
400	0.639	-142.44	8.256	98.88	0.060	44.77	0.362	-62.32
600	0.636	-156.46	5.721	88.62	0.070	47.35	0.306	-66.66
800	0.628	-165.41	4.393	80.84	0.082	51.17	0.286	-70.68
1000	0.620	-171.30	3.549	74.44	0.094	53.84	0.280	-73.86
1200	0.615	-176.02	2.981	68.87	0.108	55.37	0.285	-76.55
1400	0.606	179.70	2.584	63.58	0.121	57.13	0.297	-80.44
1600	0.599	176.38	2.298	58.72	0.134	58.54	0.307	-83.02
1800	0.589	173.12	2.065	54.21	0.149	58.63	0.319	-86.36
2000	0.586	169.27	1.889	49.40	0.165	59.48	0.329	-88.76
2200	0.573	165.75	1.719	45.30	0.179	59.22	0.344	-91.59
2400	0.567	162.49	1.589	41.42	0.195	59.66	0.362	-94.36
2600	0.562	158.91	1.481	37.55	0.211	59.11	0.374	-97.29
2800	0.558	155.91	1.385	34.30	0.229	59.13	0.388	-100.28
3000	0.548	152.46	1.310	31.07	0.248	58.50	0.400	-102.49

V<sub>CE</sub>=5V, I<sub>C</sub>=15mA, Z<sub>O</sub>=50Ω

Freq(MHz)	S11	∠S11	S21	∠S21	S12	∠S12	S22	∠S22
100	0.680	-83.50	24.897	133.56	0.029	56.21	0.704	-41.82
200	0.639	-122.13	16.056	112.77	0.040	47.85	0.468	-57.53
400	0.621	-151.34	8.769	95.48	0.052	50.10	0.300	-67.15
600	0.623	-162.54	6.015	86.49	0.064	53.63	0.258	-70.98
800	0.620	-170.29	4.606	79.25	0.079	57.27	0.244	-74.71
1000	0.611	-175.21	3.708	73.36	0.093	58.61	0.243	-78.49
1200	0.606	-179.14	3.121	67.87	0.107	60.22	0.249	-80.66
1400	0.599	176.96	2.697	63.02	0.122	61.45	0.262	-84.17
1600	0.593	174.14	2.394	58.44	0.138	61.14	0.275	-86.76
1800	0.584	170.85	2.158	54.02	0.153	61.15	0.287	-89.61
2000	0.577	167.75	1.973	49.36	0.168	61.74	0.298	-91.80
2200	0.569	164.22	1.790	45.54	0.184	61.18	0.314	-94.29
2400	0.564	160.80	1.659	41.46	0.201	60.23	0.330	-97.05
2600	0.556	157.53	1.542	37.83	0.216	60.12	0.342	-99.52
2800	0.552	154.68	1.446	34.40	0.234	59.34	0.352	-101.94
3000	0.543	151.47	1.361	31.44	0.253	58.86	0.366	-103.99

V<sub>CE</sub>=5V, I<sub>C</sub>=20mA, Z<sub>O</sub>=50Ω

Freq(MHz)	S11	∠S11	S21	∠S21	S12	∠S12	S22	∠S22
100	0.641	-94.49	27.471	128.94	0.027	55.26	0.649	-46.11
200	0.620	-130.76	16.818	109.44	0.036	46.79	0.413	-61.30
400	0.615	-156.41	9.019	93.57	0.048	53.11	0.265	-70.11
600	0.619	-165.97	6.162	85.24	0.062	57.92	0.228	-73.77
800	0.615	-172.83	4.701	78.51	0.078	61.14	0.223	-77.54
1000	0.608	-177.23	3.787	72.80	0.092	61.33	0.223	-81.02
1200	0.605	179.19	3.189	67.44	0.108	63.68	0.231	-83.24
1400	0.597	175.70	2.755	62.79	0.123	63.07	0.245	-86.33
1600	0.590	172.88	2.442	58.12	0.138	62.89	0.255	-88.33
1800	0.581	169.98	2.201	53.81	0.156	63.03	0.272	-91.87
2000	0.578	166.61	2.013	49.41	0.172	62.58	0.281	-93.44
2200	0.567	163.21	1.834	45.29	0.187	61.81	0.298	-95.50
2400	0.564	160.39	1.691	41.48	0.204	61.15	0.311	-98.00
2600	0.556	157.07	1.572	37.96	0.218	61.01	0.326	-100.45
2800	0.552	153.99	1.478	34.76	0.239	59.99	0.337	-102.57
3000	0.544	151.04	1.389	31.49	0.256	58.80	0.349	-104.89

## 55GN01FA

### S Parameters (Common emitter)

$V_{CE}=5V, I_C=30mA, Z_O=50\Omega$

Freq(MHz)	S11	$\angle S11$	S21	$\angle S21$	S12	$\angle S12$	S22	$\angle S22$
100	0.606	-108.75	29.954	123.54	0.022	52.56	0.574	-51.26
200	0.604	-140.73	17.448	105.68	0.031	50.23	0.355	-64.86
400	0.610	-161.95	9.185	91.52	0.044	57.91	0.229	-71.81
600	0.617	-169.73	6.244	83.80	0.061	62.49	0.202	-74.91
800	0.612	-175.60	4.752	77.41	0.077	64.49	0.201	-79.23
1000	0.608	-179.42	3.833	71.88	0.091	66.02	0.204	-82.01
1200	0.604	177.51	3.213	66.72	0.108	65.81	0.214	-84.26
1400	0.598	174.16	2.786	62.07	0.124	64.91	0.229	-87.74
1600	0.591	171.45	2.465	57.60	0.141	64.74	0.242	-89.81
1800	0.584	168.71	2.221	53.24	0.156	64.27	0.255	-92.03
2000	0.582	165.57	2.027	48.84	0.173	63.95	0.266	-93.76
2200	0.569	162.47	1.842	44.77	0.189	62.96	0.281	-96.01
2400	0.566	159.27	1.707	41.02	0.205	62.39	0.298	-98.15
2600	0.560	156.39	1.589	37.71	0.221	61.62	0.312	-100.74
2800	0.555	153.39	1.489	34.29	0.241	60.71	0.324	-103.01
3000	0.546	150.41	1.401	31.06	0.260	59.58	0.339	-104.84

$V_{CE}=5V, I_C=50mA, Z_O=50\Omega$

Freq(MHz)	S11	$\angle S11$	S21	$\angle S21$	S12	$\angle S12$	S22	$\angle S22$
100	0.587	-124.93	30.667	118.01	0.020	53.81	0.493	-53.52
200	0.607	-151.01	17.135	101.95	0.027	56.26	0.302	-62.86
400	0.618	-167.42	8.863	89.36	0.042	61.87	0.204	-65.99
600	0.625	-173.36	6.015	82.09	0.057	67.05	0.188	-69.08
800	0.625	-178.39	4.579	75.84	0.073	68.51	0.192	-73.08
1000	0.621	178.24	3.676	70.38	0.090	67.50	0.200	-76.57
1200	0.617	175.49	3.102	65.41	0.106	67.96	0.213	-79.88
1400	0.611	172.50	2.675	60.74	0.123	67.75	0.228	-83.13
1600	0.605	170.02	2.371	56.11	0.138	67.29	0.245	-85.73
1800	0.598	167.32	2.131	51.76	0.155	65.91	0.261	-88.36
2000	0.594	164.43	1.944	47.33	0.173	65.72	0.273	-90.18
2200	0.587	161.08	1.771	43.20	0.189	64.76	0.291	-93.08
2400	0.582	158.20	1.636	39.59	0.204	63.82	0.308	-95.85
2600	0.575	155.22	1.517	36.00	0.222	63.08	0.325	-98.58
2800	0.571	151.88	1.420	32.74	0.241	62.62	0.341	-100.91
3000	0.564	149.04	1.345	29.50	0.259	61.30	0.351	-102.73

Embossed Taping Specification

55GN01FA-TL-H

1. Packing Format

Package Name	Carrier Tape Type	Maximum Number of devices contained (pcs)			Packing format	
		Reel	Inner box	Outer box	Inner BOX (C-1)	Outer BOX (A-7)
SSFP	SSFP	8,000	40,000	240,000	5 reels contained Dimensions:mm (external) 183×72×185	6 inner boxes contained Dimension::mm (external) 440×195×210

Packing method

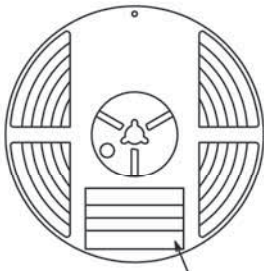

Reel label

Reel label, Inner box label  
(unit:mm)

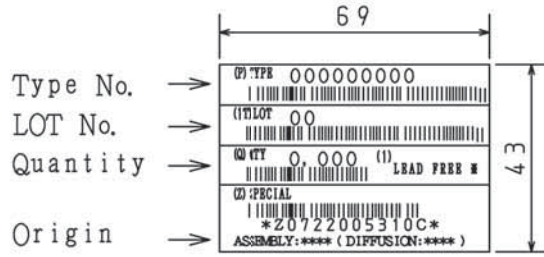

Outer box label  
It is a label at the time of factory shipments. The form of a label may change in physical distribution process.

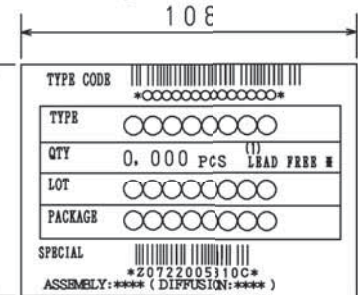

NOTE (1)

The LEAD FREE # description shows that the surface treatment of the terminal is lead free.

Label	JEITA Phase
LEAD FREE 3	JEITA Phase 3A
LEAD FREE 4	JEITA Phase 3

2. Taping configuration

2-1. Carrier tape size (unit:mm)

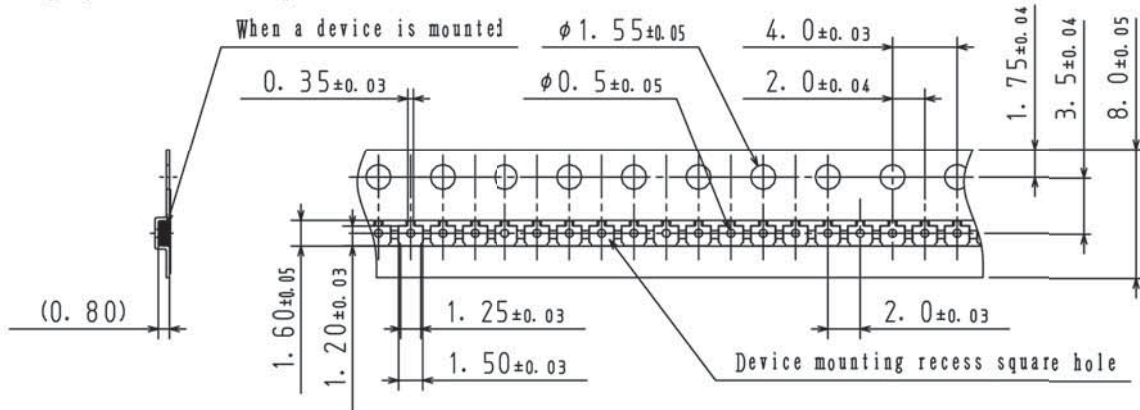

2-2. Device placement direction

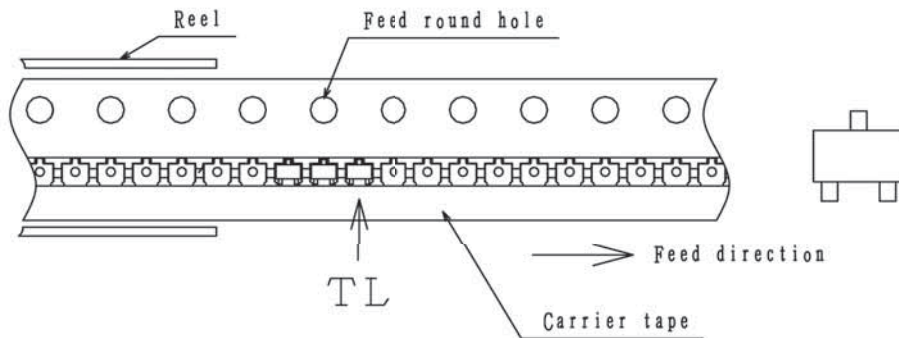

Those with pin 1 index on the feed hole side.....TL

# 55GN01FA

## Outline Drawing 55GN01FA-TL-H

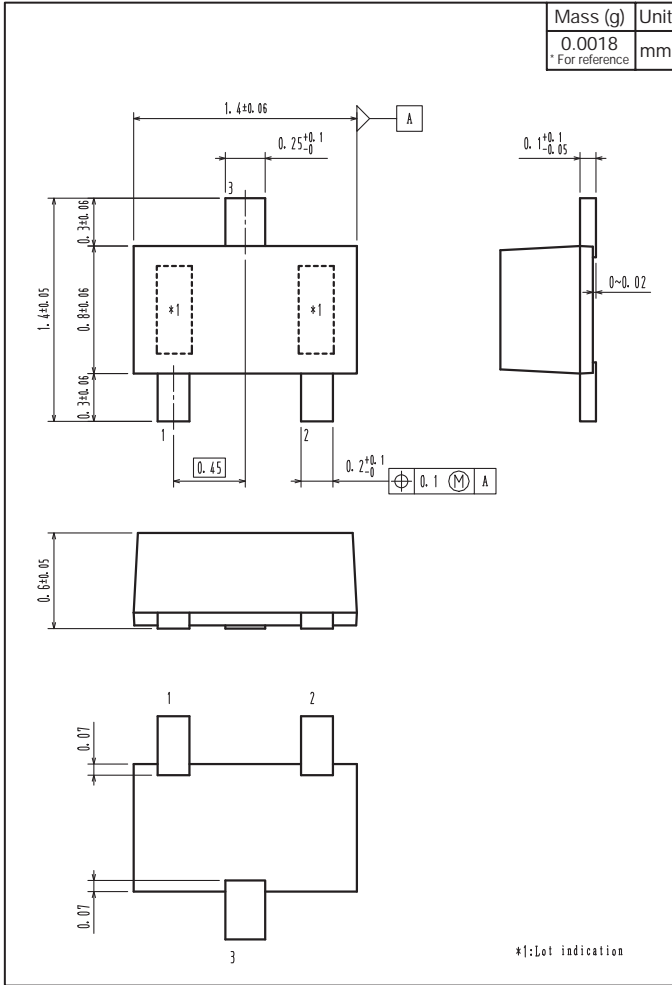

## Land Pattern Example

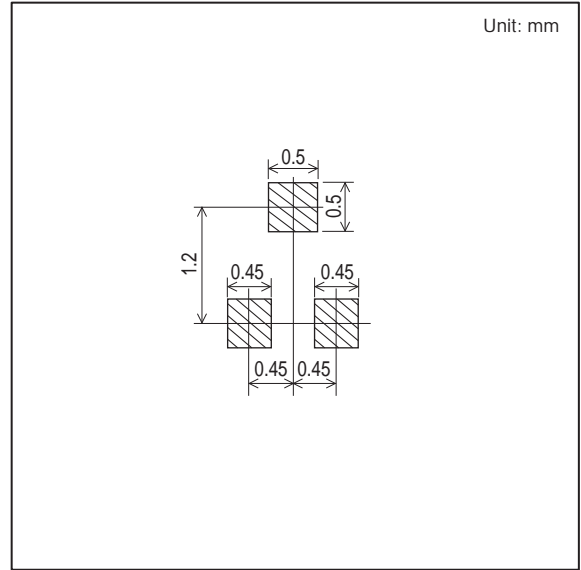



- Any and all SANYO Semiconductor Co.,Ltd. products described or contained herein are, with regard to "standard application", intended for the use as general electronics equipment. The products mentioned herein shall not be intended for use for any "special application" (medical equipment whose purpose is to sustain life, aerospace instrument, nuclear control device, burning appliances, transportation machine, traffic signal system, safety equipment etc.) that shall require extremely high level of reliability and can directly threaten human lives in case of failure or malfunction of the product or may cause harm to human bodies, nor shall they grant any guarantee thereof. If you should intend to use our products for new introduction or other application different from current conditions on the usage of automotive device, communication device, office equipment, industrial equipment etc. , please consult with us about usage condition (temperature, operation time etc.) prior to the intended use. If there is no consultation or inquiry before the intended use, our customer shall be solely responsible for the use.
- Specifications of any and all SANYO Semiconductor Co.,Ltd. products described or contained herein stipulate the performance, characteristics, and functions of the described products in the independent state, and are not guarantees of the performance, characteristics, and functions of the described products as mounted in the customer's products or equipment. To verify symptoms and states that cannot be evaluated in an independent device, the customer should always evaluate and test devices mounted in the customer's products or equipment.
- SANYO Semiconductor Co.,Ltd. assumes no responsibility for equipment failures that result from using products at values that exceed, even momentarily, rated values (such as maximum ratings, operating condition ranges, or other parameters) listed in products specifications of any and all SANYO Semiconductor Co.,Ltd. products described or contained herein.
- Regarding monolithic semiconductors, if you should intend to use this IC continuously under high temperature, high current, high voltage, or drastic temperature change, even if it is used within the range of absolute maximum ratings or operating conditions, there is a possibility of decrease reliability. Please contact us for a confirmation.
- SANYO Semiconductor Co.,Ltd. strives to supply high-quality high-reliability products, however, any and all semiconductor products fail or malfunction with some probability. It is possible that these probabilistic failures or malfunction could give rise to accidents or events that could endanger human lives, trouble that could give rise to smoke or fire, or accidents that could cause damage to other property. When designing equipment, adopt safety measures so that these kinds of accidents or events cannot occur. Such measures include but are not limited to protective circuits and error prevention circuits for safe design, redundant design, and structural design.
- In the event that any or all SANYO Semiconductor Co.,Ltd. products described or contained herein are controlled under any of applicable local export control laws and regulations, such products may require the export license from the authorities concerned in accordance with the above law.
- No part of this publication may be reproduced or transmitted in any form or by any means, electronic or mechanical, including photocopying and recording, or any information storage or retrieval system, or otherwise, without the prior written consent of SANYO Semiconductor Co.,Ltd.
- Any and all information described or contained herein are subject to change without notice due to product/technology improvement, etc. When designing equipment, refer to the "Delivery Specification" for the SANYO Semiconductor Co.,Ltd. product that you intend to use.
- Upon using the technical information or products described herein, neither warranty nor license shall be granted with regard to intellectual property rights or any other rights of SANYO Semiconductor Co.,Ltd. or any third party. SANYO Semiconductor Co.,Ltd. shall not be liable for any claim or suits with regard to a third party's intellectual property rights which has resulted from the use of the technical information and products mentioned above.

This catalog provides information as of July, 2012. Specifications and information herein are subject to change without notice.

Компания «Life Electronics» занимается поставками электронных компонентов импортного и отечественного производства от производителей и со складов крупных дистрибьюторов Европы, Америки и Азии.

С конца 2013 года компания активно расширяет линейку поставок компонентов по направлению коаксиальный кабель, кварцевые генераторы и конденсаторы (керамические, пленочные, электролитические), за счёт заключения дистрибьюторских договоров

Мы предлагаем:

- Конкуренспособные цены и скидки постоянным клиентам.
- Специальные условия для постоянных клиентов.
- Подбор аналогов.
- Поставку компонентов в любых объемах, удовлетворяющих вашим потребностям.
- Приемлемые сроки поставки, возможна ускоренная поставка.
- Доставку товара в любую точку России и стран СНГ.
- Комплексную поставку.
- Работу по проектам и поставку образцов.
- Формирование склада под заказчика.
- Сертификаты соответствия на поставляемую продукцию (по желанию клиента).
- Тестирование поставляемой продукции.
- Поставку компонентов, требующих военную и космическую приемку.
- Входной контроль качества.
- Наличие сертификата ISO.

В составе нашей компании организован Конструкторский отдел, призванный помогать разработчикам, и инженерам.

Конструкторский отдел помогает осуществить:

- Регистрацию проекта у производителя компонентов.
- Техническую поддержку проекта.
- Защиту от снятия компонента с производства.
- Оценку стоимости проекта по компонентам.
- Изготовление тестовой платы монтаж и пусконаладочные работы.



Тел: +7 (812) 336 43 04 (многоканальный)

Email: [org@lifeelectronics.ru](mailto:org@lifeelectronics.ru)