

MG17200D-BN4MM



Agency Approvals

AGENCY	AGENCY FILE NUMBER
	E71639

Features

- IGBT³ CHIP(1700V Trench+Field Stop technology)
- Low turn-off losses, short tail current
- $V_{CE(sat)}$ with positive temperature coefficient
- DIODE CHIP(1700V EMCON 3 technology)
- Free wheeling diodes with fast and soft reverse recovery

Applications

- High frequency switching application
- Medical applications
- Motion/servo control
- UPS systems

Module Characteristics ($T_c = 25^\circ\text{C}$, unless otherwise specified)

Symbol	Parameters	Test Conditions	Min	Typ	Max	Unit
$T_{J(max)}$	Max. Junction Temperature				150	$^\circ\text{C}$
$T_{J(op)}$	Operating Temperature		-40		125	$^\circ\text{C}$
T_{stg}	Storage Temperature		-40		125	$^\circ\text{C}$
V_{isol}	Insulation Test Voltage	AC, t=1min		4000		V
CTI	Comparative Tracking Index		350			
Torque	Module-to-Sink	Recommended (M6)	3		5	N·m
Torque	Module Electrodes	Recommended (M6)	2.5		5	N·m
Weight				320		g

Absolute Maximum Ratings ($T_c = 25^\circ\text{C}$, unless otherwise specified)

Symbol	Parameters	Test Conditions	Values	Unit
IGBT				
V_{CES}	Collector - Emitter Voltage	$T_J=25^\circ\text{C}$	1700	V
V_{GES}	Gate - Emitter Voltage		± 20	V
I_C	DC Collector Current	$T_c=25^\circ\text{C}$	300	A
		$T_c=80^\circ\text{C}$	200	A
I_{CM}	Repetitive Peak Collector Current	$t_p=1\text{ms}$	400	A
P_{tot}	Power Dissipation Per IGBT		1250	W
Diode				
V_{RRM}	Repetitive Reverse Voltage	$T_J=25^\circ\text{C}$	1700	V
$I_{F(AV)}$	Average Forward Current	$T_c=25^\circ\text{C}$	300	A
		$T_c=80^\circ\text{C}$	200	A
I_{FRM}	Repetitive Peak Forward Current	$t_p=1\text{ms}$	400	A
I^2t		$T_J = 125^\circ\text{C}, t = 10\text{ms}, V_R = 0\text{V}$	6500	A^2S

Life Support Note:

Not Intended for Use in Life Support or Life Saving Applications

The products shown herein are not designed for use in life sustaining or life saving applications unless otherwise expressly indicated.

Electrical and Thermal Specifications ($T_c = 25^\circ\text{C}$, unless otherwise specified)

Symbol	Parameters	Test Conditions	Min	Typ	Max	Unit
IGBT						
$V_{GE(th)}$	Gate - Emitter Threshold Voltage	$V_{CE}=V_{GE}, I_C=8.0\text{mA}$	5.2	5.8	6.4	V
$V_{CE(sat)}$	Collector - Emitter Saturation Voltage	$I_C=200\text{A}, V_{GE}=15\text{V}, T_J=25^\circ\text{C}$		2.0	2.45	V
		$I_C=200\text{A}, V_{GE}=15\text{V}, T_J=125^\circ\text{C}$		2.4		V
I_{CES}	Collector Leakage Current	$V_{CE}=1700\text{V}, V_{GE}=0\text{V}, T_J=25^\circ\text{C}$			3	mA
		$V_{CE}=1700\text{V}, V_{GE}=0\text{V}, T_J=125^\circ\text{C}$			20	mA
I_{GES}	Gate Leakage Current	$V_{CE}=0\text{V}, V_{GE}=\pm 20\text{V}, T_J=125^\circ\text{C}$	-400		400	nA
R_{Gint}	Intergrated Gate Resistor			3.8		Ω
Q_{ge}	Gate Charge	$V_{CE}=900\text{V}, I_C=200\text{A}, V_{GE}=\pm 15\text{V}$		2.3		μC
C_{ies}	Input Capacitance	$V_{CE}=25\text{V}, V_{GE}=0\text{V}, f=1\text{MHz}$		18		nF
C_{res}	Reverse Transfer Capacitance				0.6	
$t_{d(on)}$	Turn - on Delay Time	$V_{CC}=900\text{V}$ $I_C=200\text{A}$ $R_G=6.8\Omega$ $V_{GE}=\pm 15\text{V}$ Inductive Load	$T_J=25^\circ\text{C}$		280	ns
			$T_J=125^\circ\text{C}$		380	ns
t_r	Rise Time		$T_J=25^\circ\text{C}$		80	ns
			$T_J=125^\circ\text{C}$		100	ns
$t_{d(off)}$	Turn - off Delay Time		$T_J=25^\circ\text{C}$		800	ns
			$T_J=125^\circ\text{C}$		1000	ns
t_f	Fall Time		$T_J=25^\circ\text{C}$		120	ns
			$T_J=125^\circ\text{C}$		200	ns
E_{on}	Turn - on Energy		$T_J=25^\circ\text{C}$		58	mJ
			$T_J=125^\circ\text{C}$		78	mJ
E_{off}	Turn - off Energy	$T_J=25^\circ\text{C}$		43	mJ	
		$T_J=125^\circ\text{C}$		63	mJ	
I_{SC}	Short Circuit Current	$t_{psc}\leq 10\mu\text{S}, V_{GE}=15\text{V}, T_J=125^\circ\text{C}, V_{CC}=1000\text{V}$		800		A
R_{thJC}	Junction-to-Case Thermal Resistance (Per IGBT)				0.1	K/W
Diode						
V_F	Forward Voltage	$I_F=200\text{A}, V_{GE}=0\text{V}, T_J=25^\circ\text{C}$		1.8	2.2	V
		$I_F=200\text{A}, V_{GE}=0\text{V}, T_J=125^\circ\text{C}$		1.9		V
I_{RRM}	Max. Reverse Recovery Current	$I_F=200\text{A}, V_R=900\text{V}$		230		A
Q_{rr}	Reverse Recovery Charge	$di_f/dt=-2700\text{A}/\mu\text{s}$		85		μC
E_{rec}	Reverse Recovery Energy	$T_J=125^\circ\text{C}$		48		mJ
R_{thJCD}	Junction-to-Case Thermal Resistance (Per Diode)				0.16	K/W

Figure 1: Typical Output Characteristics

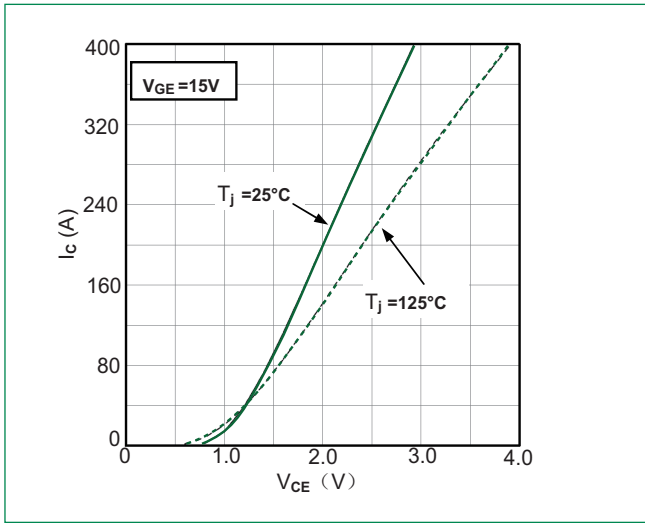

Figure 2: Typical Output Characteristics

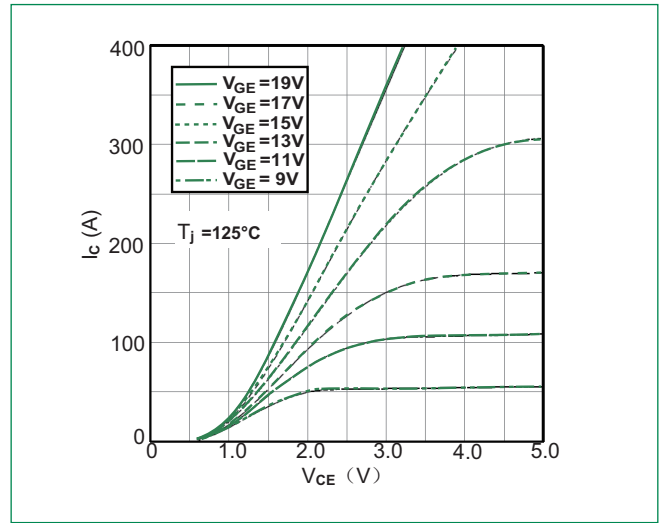

Figure 3: Typical Transfer characteristics

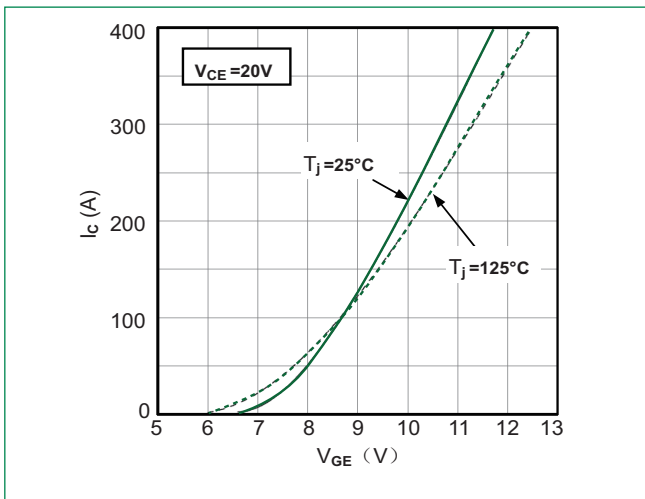

Figure 4: Switching Energy vs. Gate Resistor

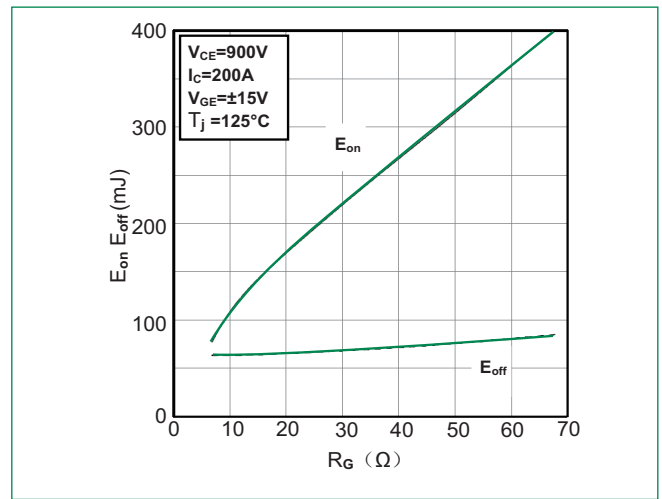

Figure 5: Switching Energy vs. Collector Current

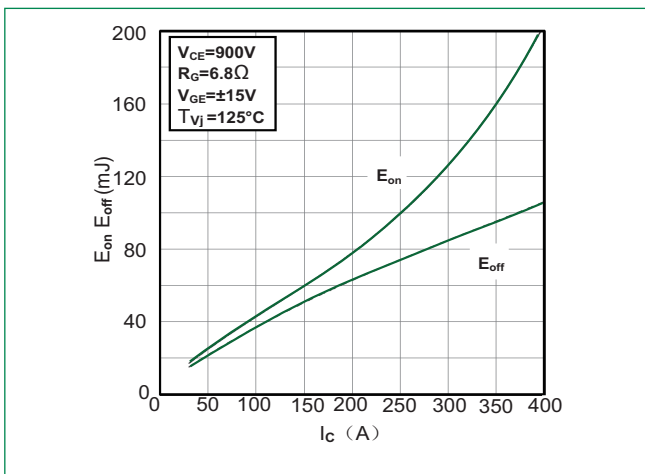

Figure 6: Reverse Biased Safe Operating Area

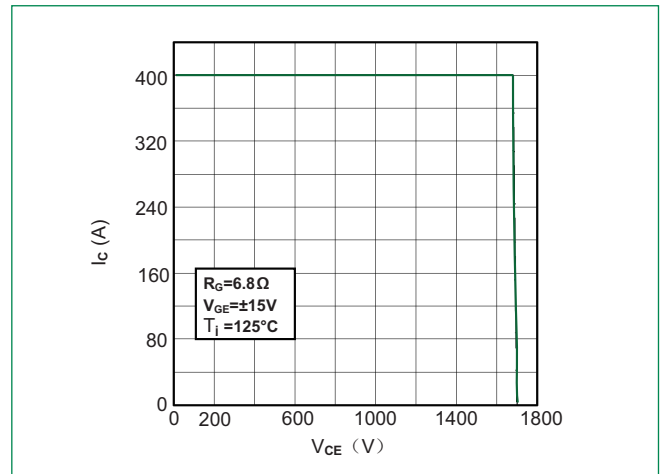

Figure 7: Diode Forward Characteristics

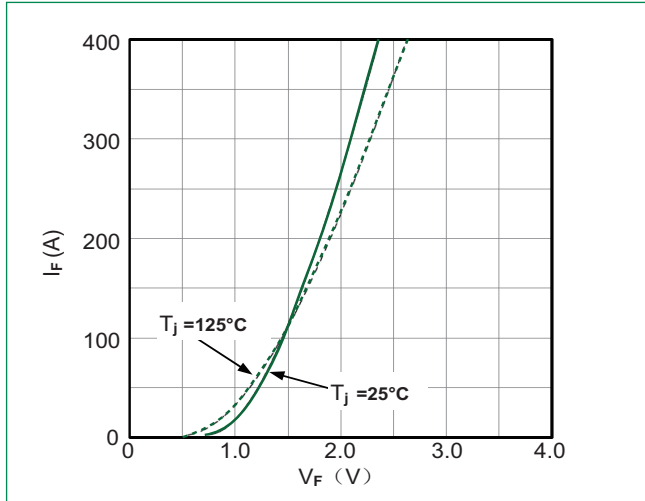

Figure 8: Switching Energy vs. Gate Resistor

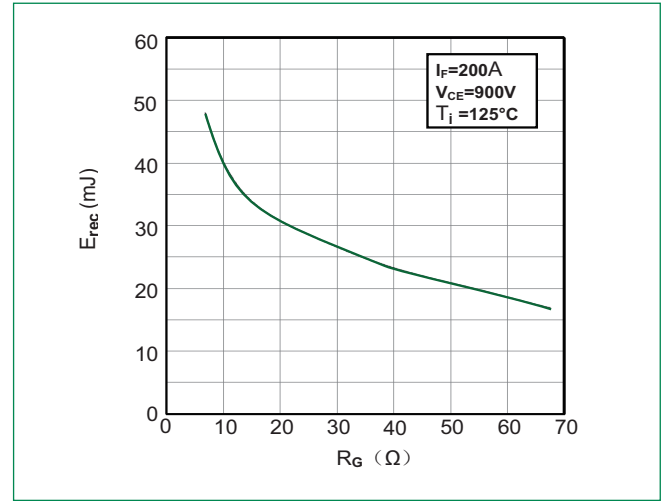

Figure 9: Switching Energy vs. Forward Current

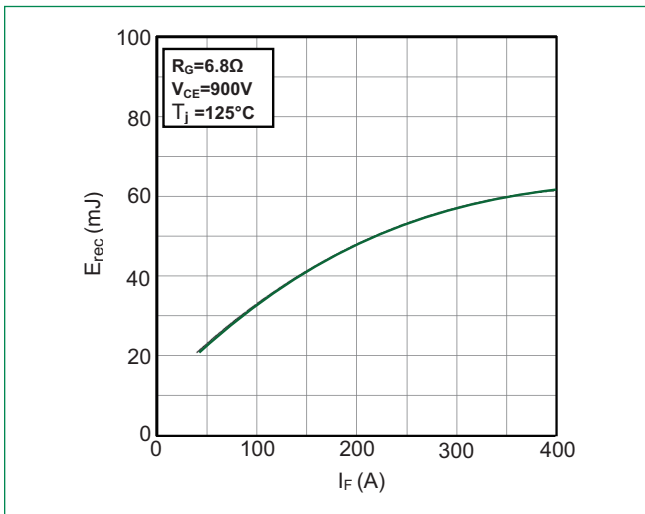
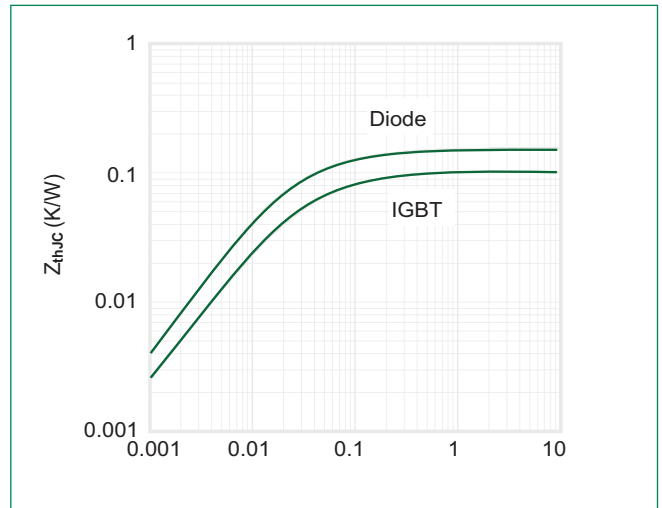
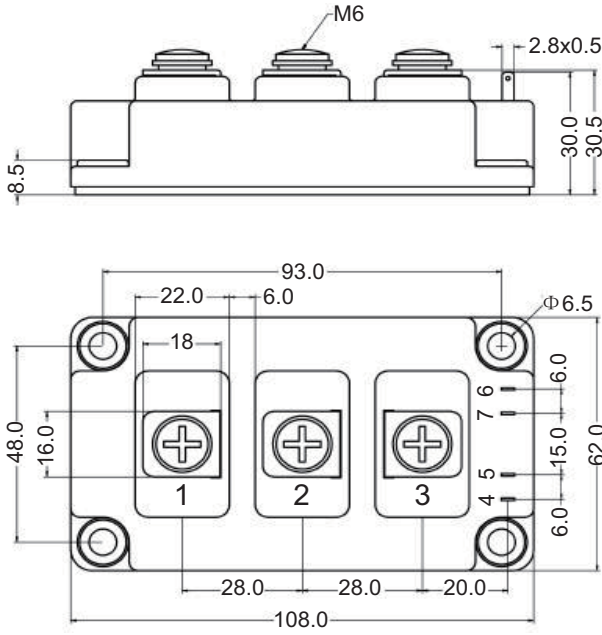

Figure 10: Transient Thermal Impedance of Diode and IGBT



Dimensions-Package D



Dimensions in mm

Circuit Diagram

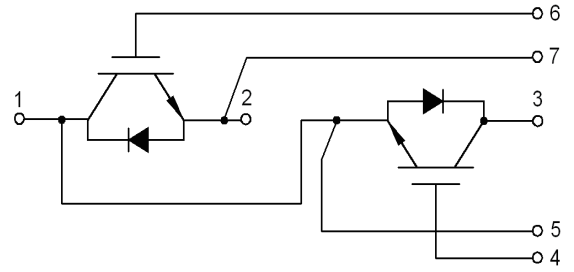

Packing Options

Part Number	Marking	Weight	Packing Mode	M.O.Q
MG17200D-BN4MM	MG17200D-BN4MM	320g	Bulk Pack	30

Part Numbering System

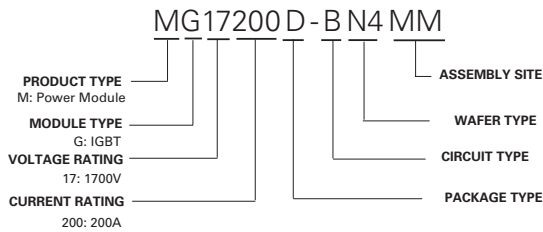

Part Marking System

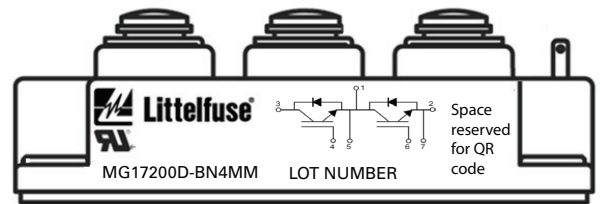

Компания «Life Electronics» занимается поставками электронных компонентов импортного и отечественного производства от производителей и со складов крупных дистрибьюторов Европы, Америки и Азии.

С конца 2013 года компания активно расширяет линейку поставок компонентов по направлению коаксиальный кабель, кварцевые генераторы и конденсаторы (керамические, пленочные, электролитические), за счёт заключения дистрибьюторских договоров

Мы предлагаем:

- Конкурентоспособные цены и скидки постоянным клиентам.
- Специальные условия для постоянных клиентов.
- Подбор аналогов.
- Поставку компонентов в любых объемах, удовлетворяющих вашим потребностям.
- Приемлемые сроки поставки, возможна ускоренная поставка.
- Доставку товара в любую точку России и стран СНГ.
- Комплексную поставку.
- Работу по проектам и поставку образцов.
- Формирование склада под заказчика.
- Сертификаты соответствия на поставляемую продукцию (по желанию клиента).
- Тестирование поставляемой продукции.
- Поставку компонентов, требующих военную и космическую приемку.
- Входной контроль качества.
- Наличие сертификата ISO.

В составе нашей компании организован Конструкторский отдел, призванный помогать разработчикам, и инженерам.

Конструкторский отдел помогает осуществить:

- Регистрацию проекта у производителя компонентов.
- Техническую поддержку проекта.
- Защиту от снятия компонента с производства.
- Оценку стоимости проекта по компонентам.
- Изготовление тестовой платы монтаж и пусконаладочные работы.



Тел: +7 (812) 336 43 04 (многоканальный)

Email: org@lifeelectronics.ru