



---

# IQS316EV02 Evaluation Kit User Guide

## IQ Switch® - ProxSense® Series

IQS316 EV-Kit and software GUI

---

### 1 Introduction

This user guide describes the operation of the IQS316 Evaluation Kit. The EV-Kit is manufactured in three parts, consisting of a controller board, and two separate plug-in keypad boards. The controller board is interfaced to any personal computer with the Azoteq Configuration Tool (CT120/200/220) or DS100 Data Streamer, and the IQS316 Graphical User Interface (GUI). The keypad module boards consist of a 16-key touchpanel and an 8-key

touchpanel. The purpose of the IQS316 EV-Kit is to facilitate application and development engineers in evaluating the IQS316 proximity and touch sensor.

A digital copy of this user guide is available for download at:

[http://www.azoteq.com/images/stories/pdf/iqs316ev02\\_user\\_manual.pdf](http://www.azoteq.com/images/stories/pdf/iqs316ev02_user_manual.pdf)

### 2 IQS316 EV-Kit Controller Board

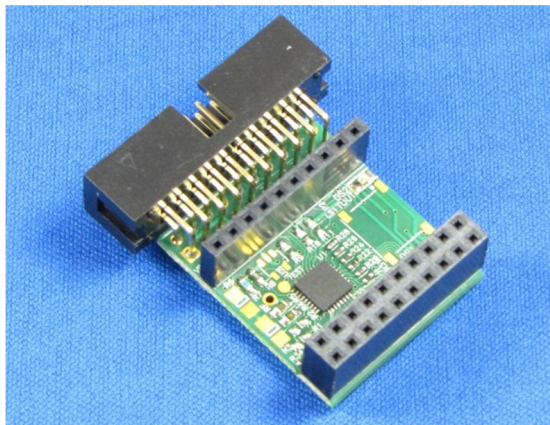


Figure 2.1 Top view of IQS316 EV-Kit controller board

### 3 16-Key Touchpanel

This demo utilises the 16-Key touchpanel interfaced to the IQS316 controller board. The 16-Key touchpanel plugs into the controller board port. The controller board is in turn interfaced to a personal computer running the IQS316 Demo GUI software, by means of a CT120/200. The touchpanel is illustrated in Figure 3.1

The 16 touch keys have a 1mm thick plexiglass overlay and are arranged in a 4

x 4 matrix, labelled from 1 to 16. A green LED is used to indicate proximity, and a blue LED to indicate when a key is touched.



Figure 3.1 16-Key Touchpanel

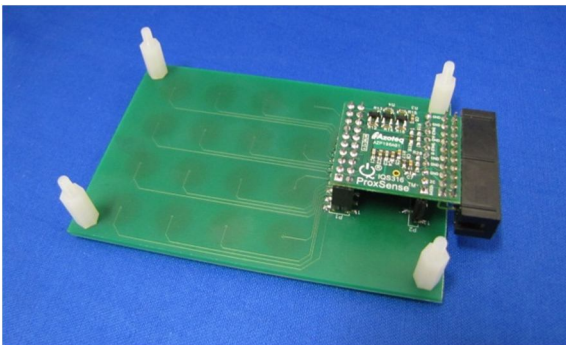


Figure 3.2 16-Key Touchpanel with controller board attached

The 16-Key touchpanel with attached controller board is depicted in Figure 3.2.

## 4 8-Key Touchpanel

The 8-Key touchpanel is interfaced to the IQS316 Controller board in the same way as the 16-Key touchpanel, by simply plugging it into the controller board port.



Figure 4.1 8-Key Touchpanel

The 8-Key touchpanel is illustrated in Figure 4.1. The 8 touchkeys are arranged in a 2 x 4 matrix and covered by a 1 mm plexiglass overlay.

Each touchkey has a green LED in the centre of the key, and all 8 LEDs illuminate simultaneously upon the detection of a proximity condition. Each touchkey has a blue LED located above the key, which indicates individual key presses.

## 5 Using the Software GUI

- Download and install the IQS316 software GUI available for download at:  
[http://www.azoteq.com/images/stories/software/azoteq\\_iqs316\\_setup.zip](http://www.azoteq.com/images/stories/software/azoteq_iqs316_setup.zip)
- Plug in the ribbon cable provided into the CT(120/200/220) Configuration Tool or DS100 Data Streamer, and into the controller board.
- Plug the desired keypad into the controller board.
- After opening the GUI, the following screen is displayed as illustrated in Figure 5.1.

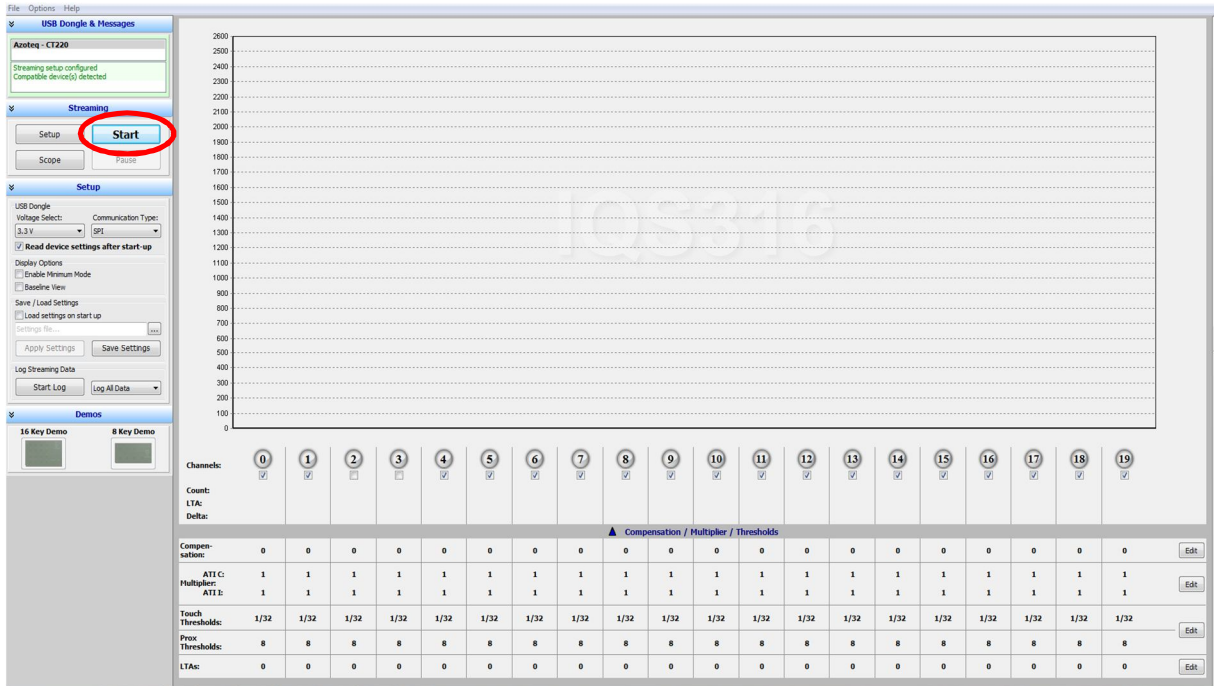


Figure 5.1 Start-up Screen for the IQS316 GUI

- Click on “Start” as illustrated in Figure 5.1.

### 5.1 16-Key Demo

- To enter the 16-Key Demo mode, click on “16 Key Demo” in the lower left-hand corner of the IQS316 GUI start-up screen, as indicated in Figure 5.2.

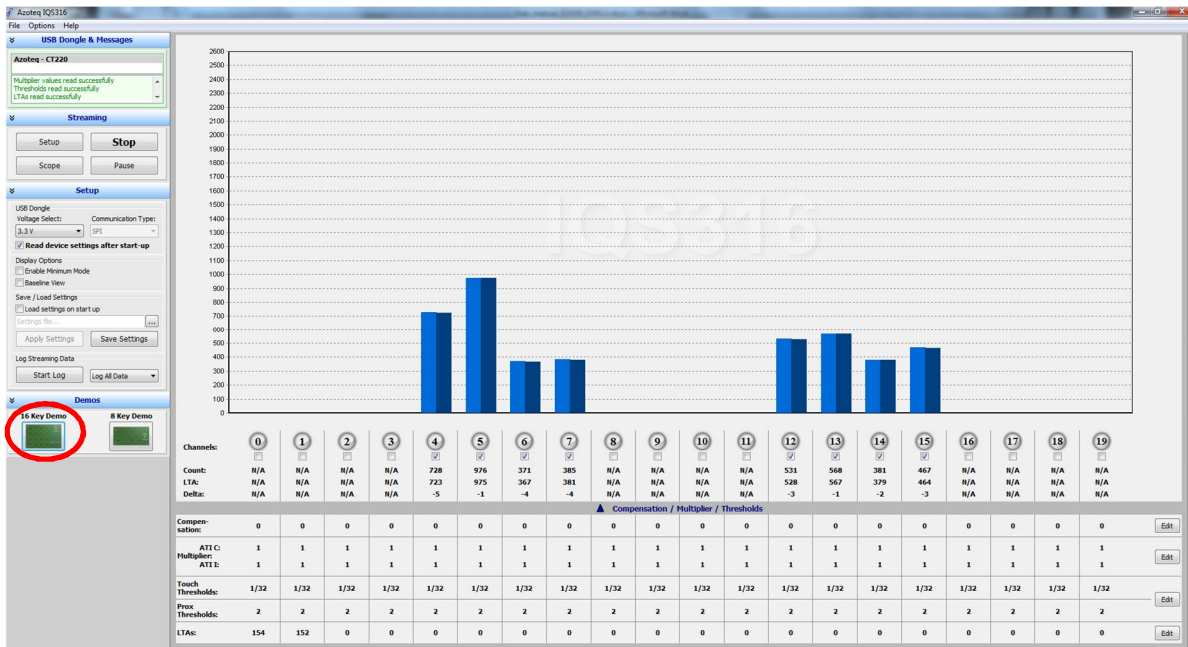


Figure 5.2 Start-up Screen for the IQS316 GUI

See Figure 5.3 for the next steps.

- Click on “Load optimal settings” as depicted in Figure 5.3.



- The device settings can be viewed and adjusted by clicking on the bar on the right-hand side of the GUI, as depicted in Figure 5.3.



Figure 5.3 Setting up the GUI for 16-Key Demo operation

- Figure 5.4 displays the device setting menu:

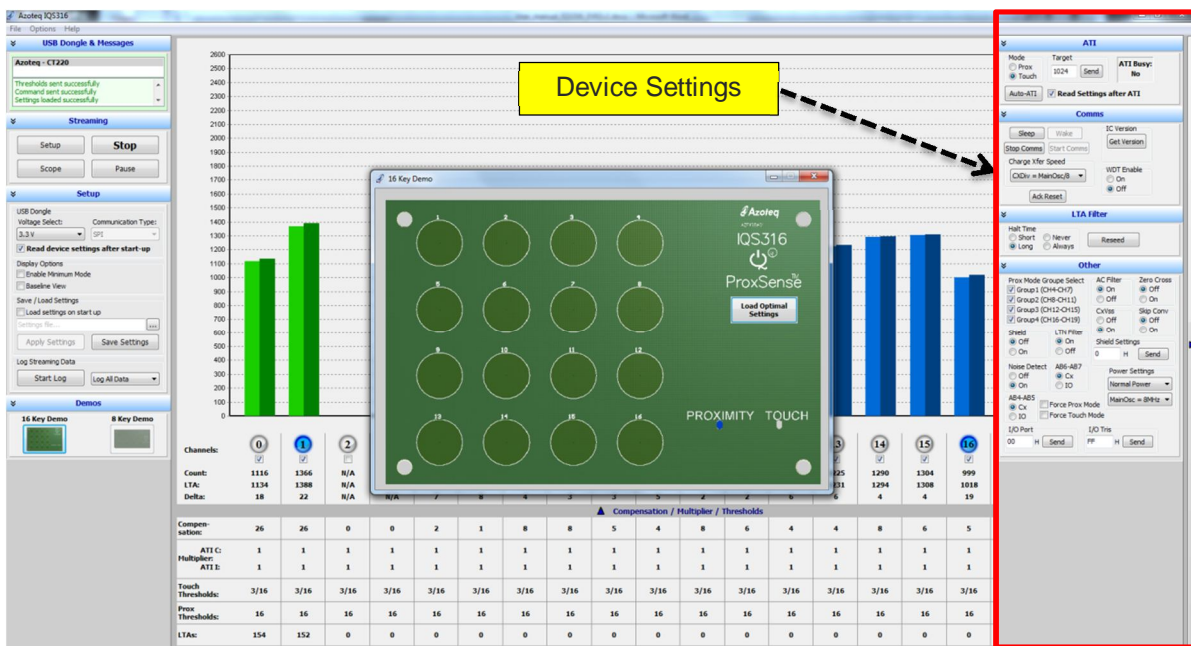


Figure 5.4 Device settings menu



## 5.2 8-Key Demo

- To enter the 8-Key Demo mode, click on “8 Key Demo” in the lower left-hand corner of the IQS316 GUI start-up screen, as indicated in Figure 5.5.

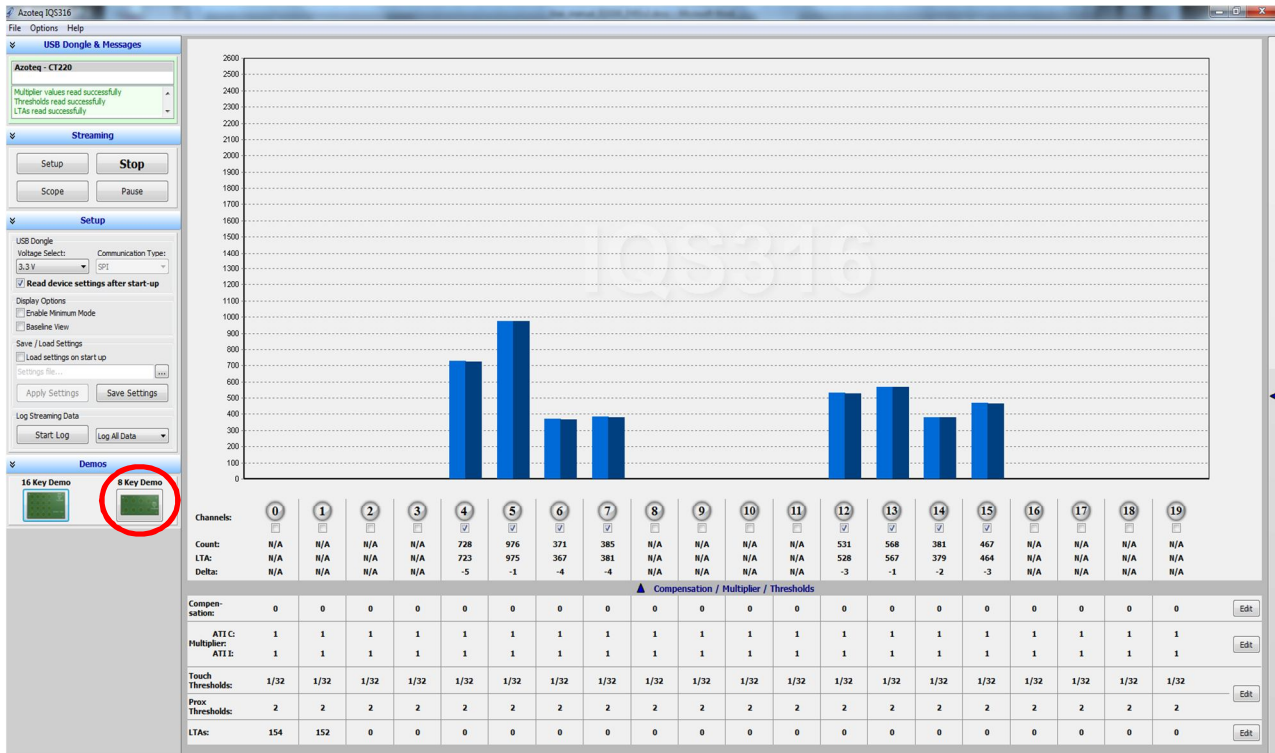


Figure 5.5 Start-up Screen for the IQS316 GUI

See Figure 5.6 for the next steps.

- Click on “Load optimal settings” as depicted in Figure 5.6.
- The device settings can be viewed and adjusted by clicking on the bar on the right-hand side of the GUI, as depicted in Figure 5.6.

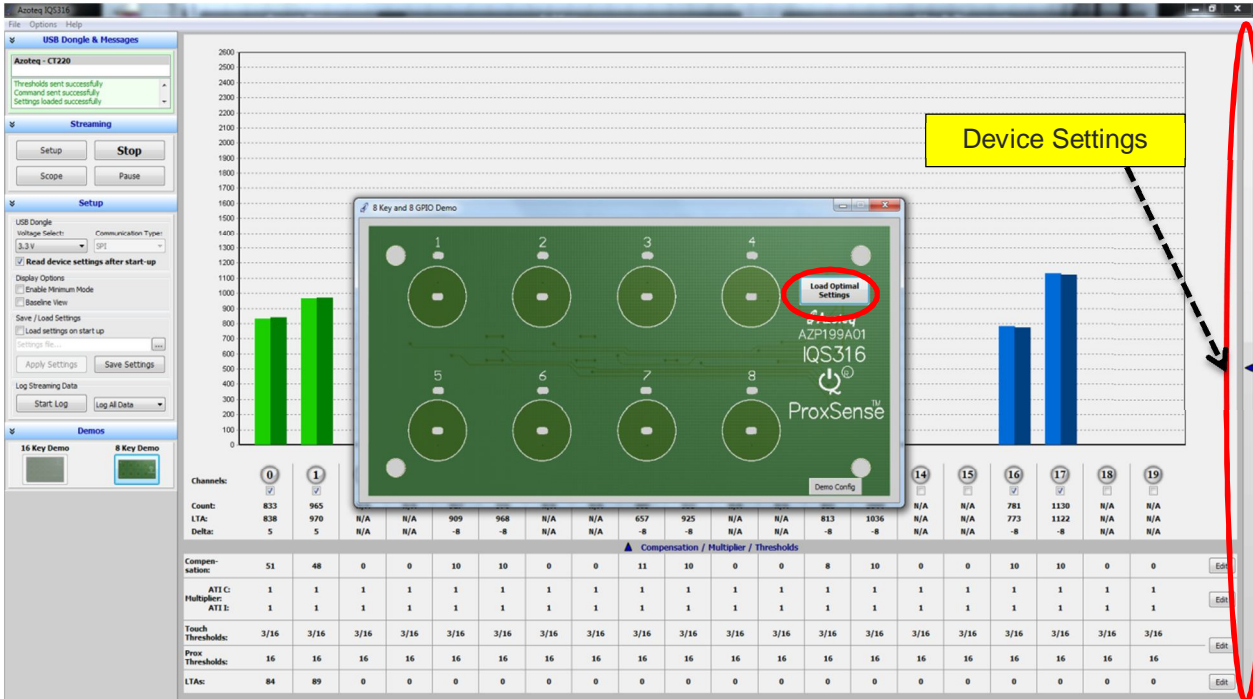


Figure 5.6 Setting up the GUI for 8-Key Demo operation

□ Figure 5.7 displays the device setting menu:

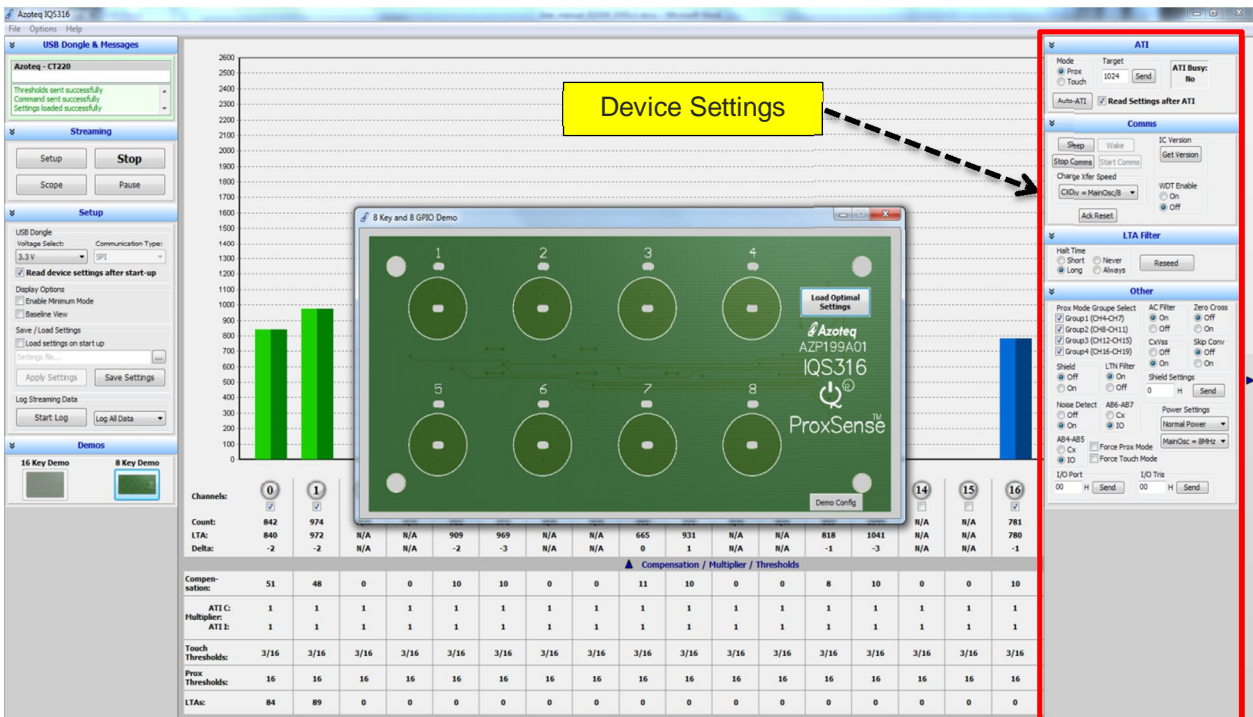
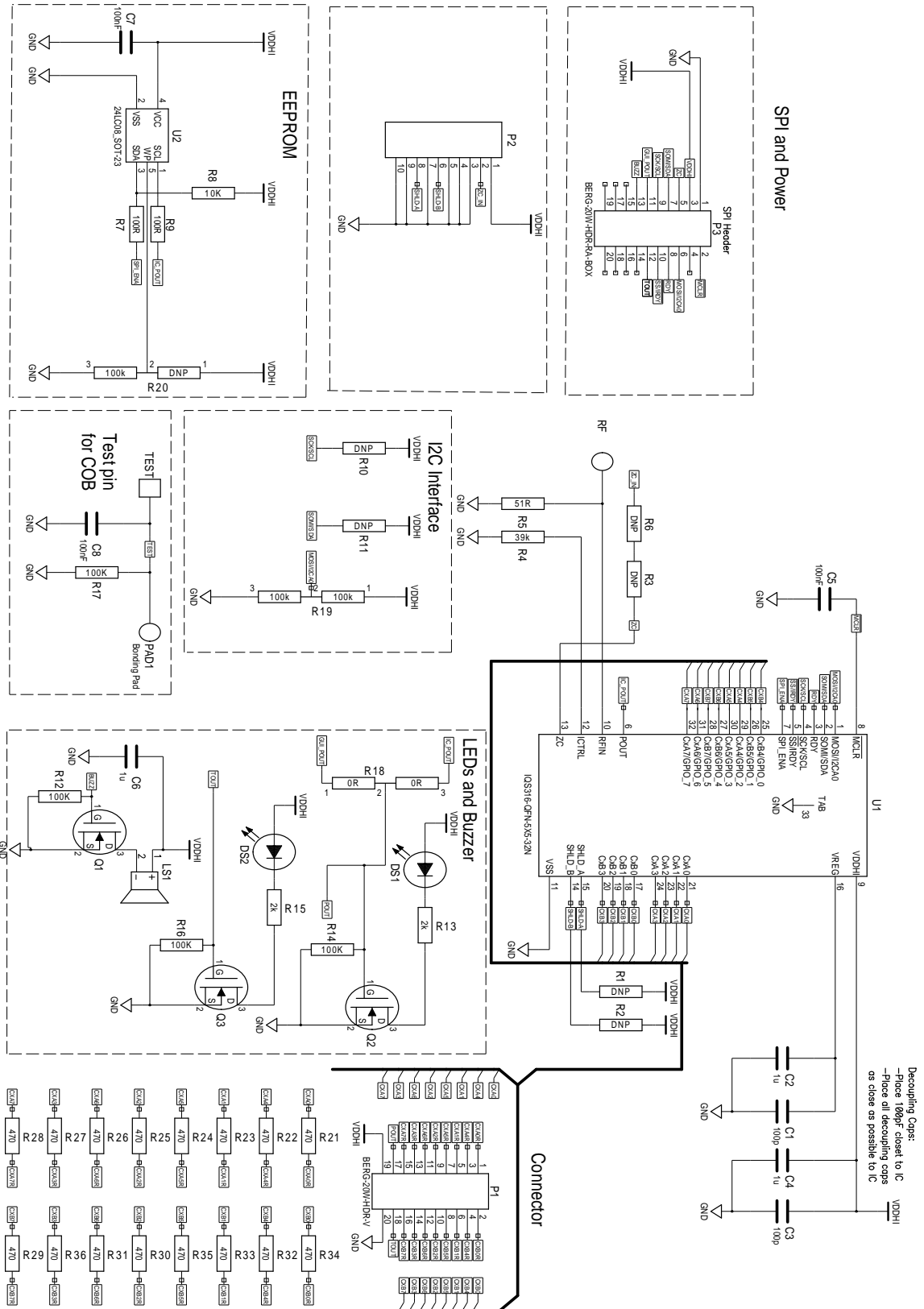


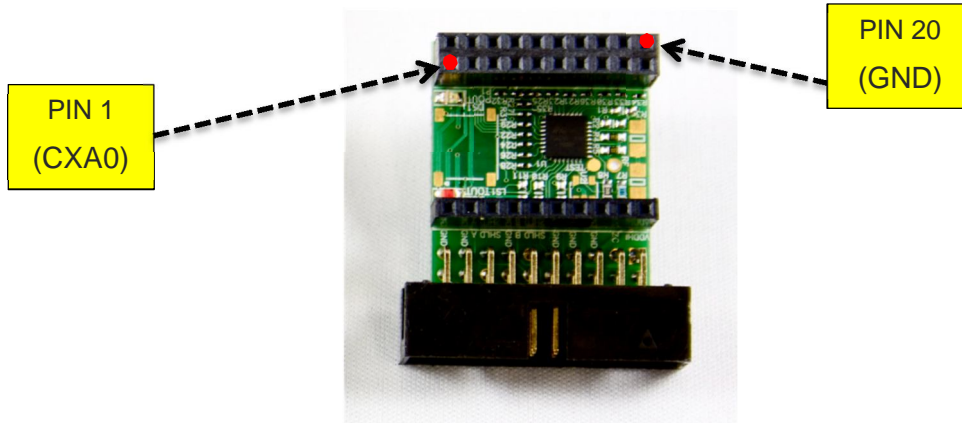
Figure 5.7 Device settings menu



## 6 Reference design

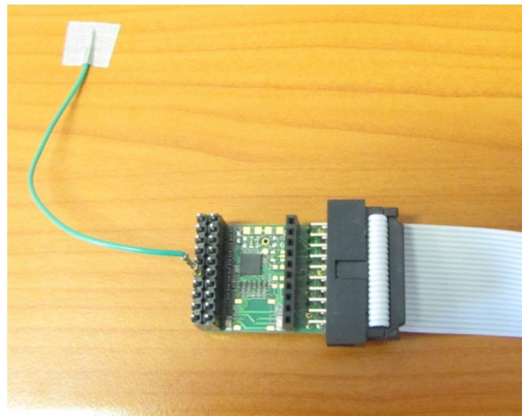


**Figure 6.1 IQS316 reference design**



**Figure 6.2 IQS316 Controller Module**

The IQS316 Controller Module is illustrated in Figure 4.2, indicating PIN 1, and PIN20 of the connector.



**Figure 6.3 Simple touchkey connected to IQS316 Controller**

A simple touchpad created out of ordinary wire and conductive tape is illustrated in Figure 4.3. This image illustrates the ease with which external electrodes can be connected to the IQS316 Controller module.

Please note: If the IQS316 Controller Module is connected to a power supply derived from the mains supply, FTB (Fast Transient Burst) spikes could possibly cause interference and undesired operation. For information on how to solve this problem please refer to application note “AZD051 - Electrical Fast Transient Burst Guidelines”.

[http://www.azoteq.com/images/stories/pdf/azd051\\_electrical\\_fast\\_transient\\_burst\\_guidelines.pdf](http://www.azoteq.com/images/stories/pdf/azd051_electrical_fast_transient_burst_guidelines.pdf)


For touch button design guidelines, please refer to application note AZD008 – “Design Guidelines for Touch Pads”, on the Azoteq website:

[http://www.azoteq.com/images/stories/pdf/azd008\\_design\\_guidelines.pdf](http://www.azoteq.com/images/stories/pdf/azd008_design_guidelines.pdf)





The following patents relate to the device or usage of the device: US 6,249,089 B1, US 6,621,225 B2, US 6,650,066 B2, US 6,952,084 B2, US 6,984,900 B1, US 7,084,526 B2, US 7,084,531 B2, US 7,119,459 B2, US 7,265,494 B2, US 7,291,940 B2, US 7,329,970 B2, US 7,336,037 B2, US 7,443,101 B2, US 7,466,040 B2, US 7,498,749 B2, US 7,528,508 B2, US 7,755,219 B2, US 7,772,781, US 7,781,980 B2, US 7,915,765 B2, EP 1 120 018 B1, EP 1 206 168 B1, EP 1 308 913 B1, EP 1 530 178 B1, ZL 99 8 14357.X, AUS 761094

IQ Switch®, ProxSense®, LightSense™, AirButton® and the  logo are trademarks of Azoteq.

The information in this Datasheet is believed to be accurate at the time of publication. Azoteq assumes no liability arising from the use of the information or the product. The applications mentioned herein are used solely for the purpose of illustration and Azoteq makes no warranty or representation that such applications will be suitable without further modification, nor recommends the use of its products for application that may present a risk to human life due to malfunction or otherwise. Azoteq products are not authorized for use as critical components in life support devices or systems. No licenses to patents are granted, implicitly or otherwise, under any intellectual property rights. Azoteq reserves the right to alter its products without prior notification. For the most up-to-date information, please refer to [www.azoteq.com](http://www.azoteq.com).

**[WWW.AZOTEQ.COM](http://WWW.AZOTEQ.COM)**

**[ProxSenseSupport@azoteq.com](mailto:ProxSenseSupport@azoteq.com)**

Компания «Life Electronics» занимается поставками электронных компонентов импортного и отечественного производства от производителей и со складов крупных дистрибьюторов Европы, Америки и Азии.

С конца 2013 года компания активно расширяет линейку поставок компонентов по направлению коаксиальный кабель, кварцевые генераторы и конденсаторы (керамические, пленочные, электролитические), за счёт заключения дистрибьюторских договоров

Мы предлагаем:

- Конкурентоспособные цены и скидки постоянным клиентам.
- Специальные условия для постоянных клиентов.
- Подбор аналогов.
- Поставку компонентов в любых объемах, удовлетворяющих вашим потребностям.
- Приемлемые сроки поставки, возможна ускоренная поставка.
- Доставку товара в любую точку России и стран СНГ.
- Комплексную поставку.
- Работу по проектам и поставку образцов.
- Формирование склада под заказчика.
- Сертификаты соответствия на поставляемую продукцию (по желанию клиента).
- Тестирование поставляемой продукции.
- Поставку компонентов, требующих военную и космическую приемку.
- Входной контроль качества.
- Наличие сертификата ISO.

В составе нашей компании организован Конструкторский отдел, призванный помогать разработчикам, и инженерам.

Конструкторский отдел помогает осуществить:

- Регистрацию проекта у производителя компонентов.
- Техническую поддержку проекта.
- Защиту от снятия компонента с производства.
- Оценку стоимости проекта по компонентам.
- Изготовление тестовой платы монтаж и пусконаладочные работы.



Тел: +7 (812) 336 43 04 (многоканальный)  
Email: [org@lifeelectronics.ru](mailto:org@lifeelectronics.ru)