



## GaAs MMIC I/Q Mixer 8 - 12 GHz

### Typical Applications

The HMC1056LP4BE is ideal for:

- Point-to-Point and Point-to-Multi-Point Radio
- Military Radar, EW & ELINT
- Satellite Communications
- Sensors

### Features

- Wide IF Bandwidth: DC - 4 GHz
- Image Rejection: 25 dBc
- LO to RF isolation: 40 dB
- High Input IP3: 18 dBm
- 20 Lead 4x4 mm SMT Package: 16 mm<sup>2</sup>

### Functional Diagram

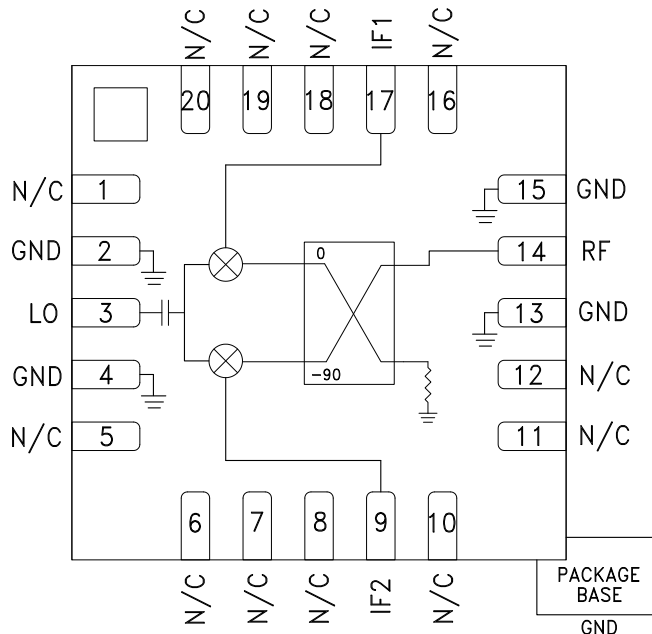

### General Description

The HMC1056LP4BE is a compact I/Q MMIC mixer in a leadless "Pb free" SMT package, which can be used as either an Image Reject Mixer or a Single Sideband Upconverter. The mixer utilizes two standard Hittite double balanced mixer cells and a 90 degree hybrid fabricated in a GaAs Schottky diode process. A low frequency quadrature hybrid was used to produce a 100MHz LSB IF output. This product is a much smaller alternative to hybrid style Image Reject Mixers and Single Sideband Upconverter assemblies. The HMC1056LP4BE eliminates the need for wire bonding and allows the use of surface mount manufacturing techniques.

### Electrical Specifications, $T_A = +25^\circ\text{C}$ , IF = 100 MHz, LSB, LO = +10 dBm [1]

Parameter	Min.	Typ.	Max.	Min.	Typ.	Max.	Units
Frequency Range, RF/LO		8 - 10			10 - 12		GHz
Frequency Range, IF		DC - 4			DC - 4		GHz
Conversion Loss		8	11		8	11	dB
Image Rejection	18	25		12	18		dBc
LO to RF isolation	33	40		33	40		dB
LO to IF isolation		35			40		dB
IP3 (input)		18			17		dBm
Amplitude Balance [2]		+0.5			+1.5		dB
Phase Balance [2]		+2.5			-2.5		Deg

[1] Unless otherwise noted all measurements performed as downconverter.

[2] Data taken without external 90° hybrid.



**GaAs MMIC I/Q Mixer  
8 - 12 GHz**

**Data Taken as SSB Downconverter with External IF 90° Hybrid, IF = 100 MHz**

**Conversion Gain, LSB vs. Temperature**

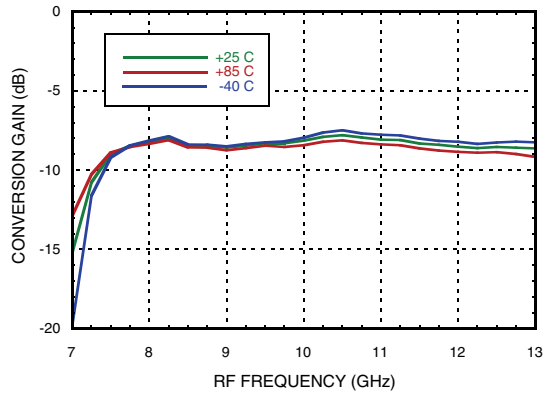

**Conversion Gain, LSB vs. LO Drive**

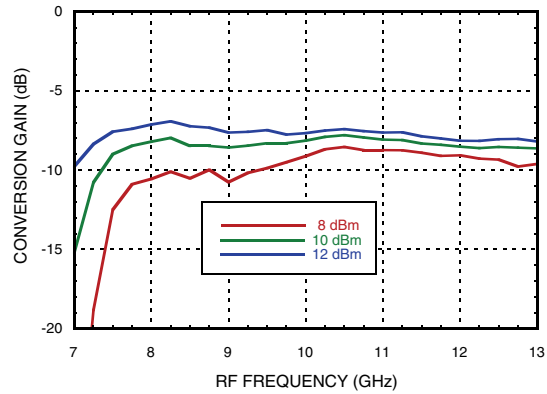

**Image Rejection, LSB vs. Temperature**

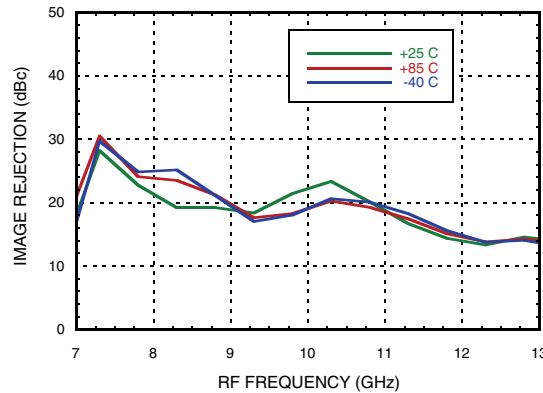

**Image Rejection, LSB vs. LO Drive**

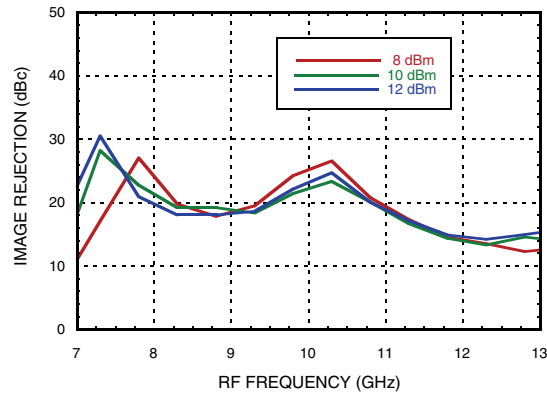

**Return Loss**

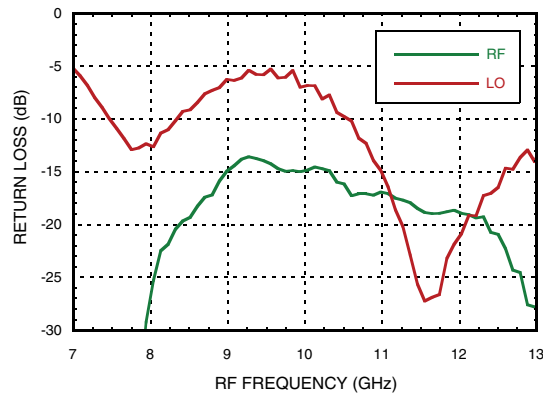

**Input P1dB, LSB vs. Temperature**

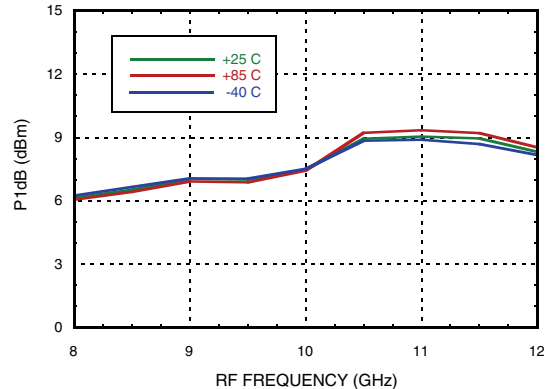

[1] Data taken without external IF 90° hybrid

Information furnished by Analog Devices is believed to be accurate and reliable. However, no responsibility is assumed by Analog Devices for its use, nor for any infringements of patents or other rights of third parties that may result from its use. Specifications subject to change without notice. No license is granted by implication or otherwise under any patent or patent rights of Analog Devices. Trademarks and registered trademarks are the property of their respective owners.

For price, delivery, and to place orders: Analog Devices, Inc., One Technology Way, P.O. Box 9106, Norwood, MA 02062-9106 Phone: 781-329-4700 • Order online at [www.analog.com](http://www.analog.com) Application Support: Phone: 1-800-ANALOG-D



**GaAs MMIC I/Q Mixer  
8 - 12 GHz**

**Data Taken as SSB Downconverter with External IF 90° Hybrid, IF = 100 MHz**

**Input IP3, LSB vs. Temperature**

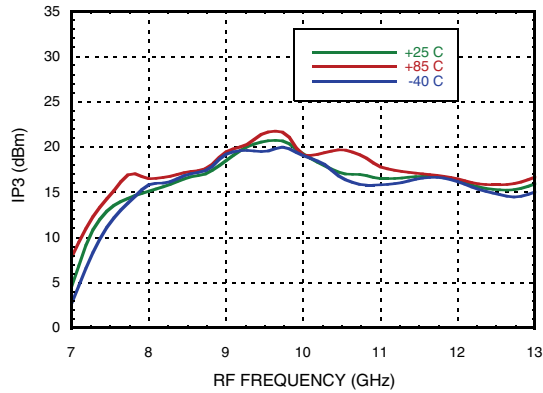

**Input IP3, LSB vs. LO Drive**

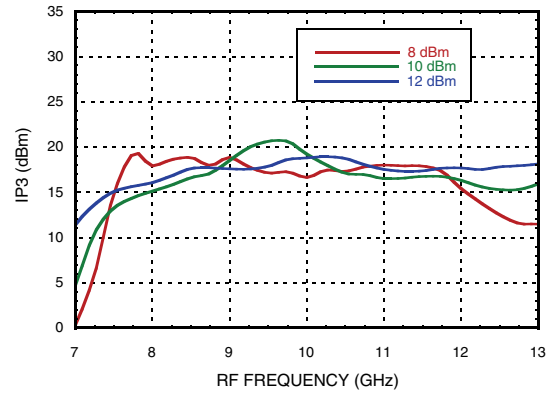

**Isolations**

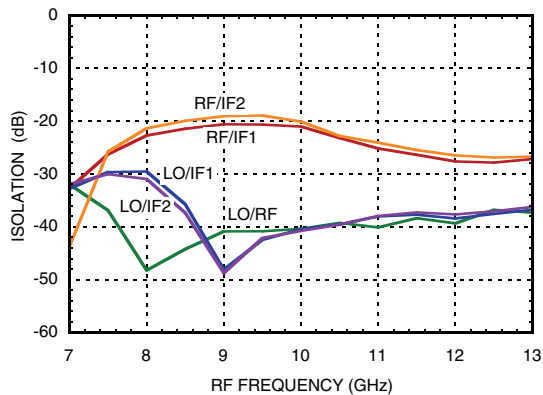

**IF Bandwidth\***

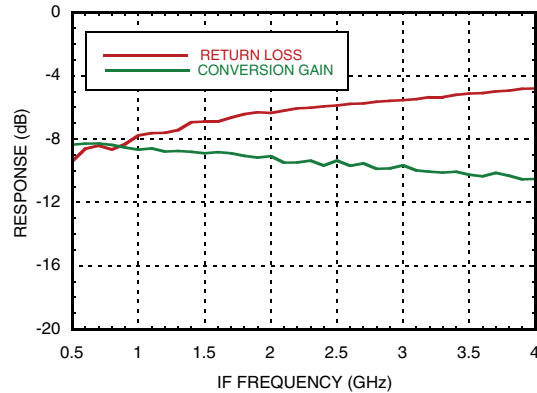

**Amplitude Balance, LSB vs. LO Drive**

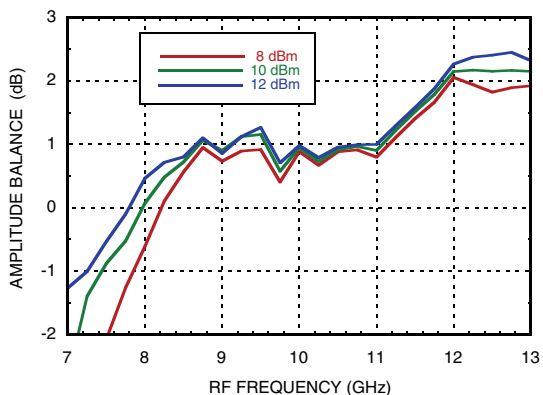

**Phase Balance, LSB vs. LO Drive**

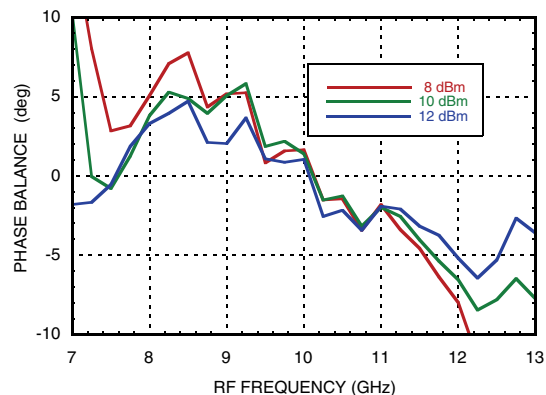

\* Conversion gain data taken with external IF hybrid.

Information furnished by Analog Devices is believed to be accurate and reliable. However, no responsibility is assumed by Analog Devices for its use, nor for any infringements of patents or other rights of third parties that may result from its use. Specifications subject to change without notice. No license is granted by implication or otherwise under any patent or patent rights of Analog Devices. Trademarks and registered trademarks are the property of their respective owners.

For price, delivery, and to place orders: Analog Devices, Inc., One Technology Way, P.O. Box 9106, Norwood, MA 02062-9106 Phone: 781-329-4700 • Order online at [www.analog.com](http://www.analog.com) Application Support: Phone: 1-800-ANALOG-D



**GaAs MMIC I/Q Mixer  
8 - 12 GHz**

**Data Taken as SSB Downconverter with External IF 90° Hybrid, IF = 100 MHz**

**Upconverter Performance, Conversion Gain, LSB vs. LO Drive**

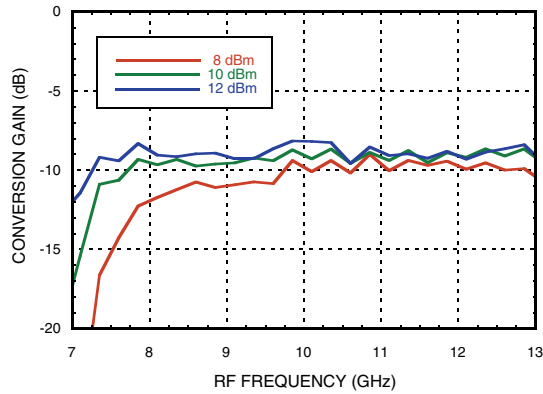

**Upconverter Performance, Sideband Rejection, LSB vs. LO Drive,**

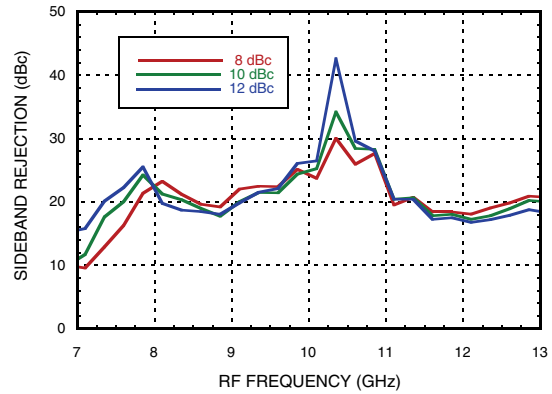

**Conversion Gain, USB vs. Temperature**

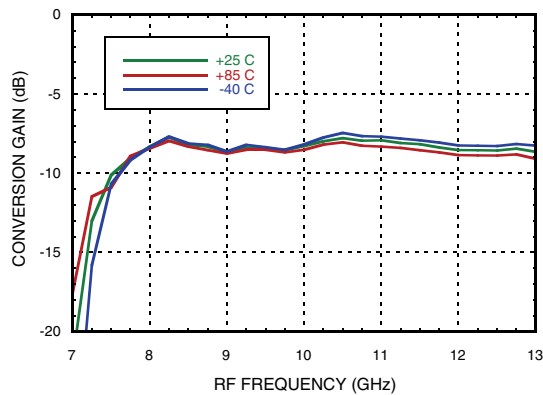

**Conversion Gain, USB vs. LO Drive**

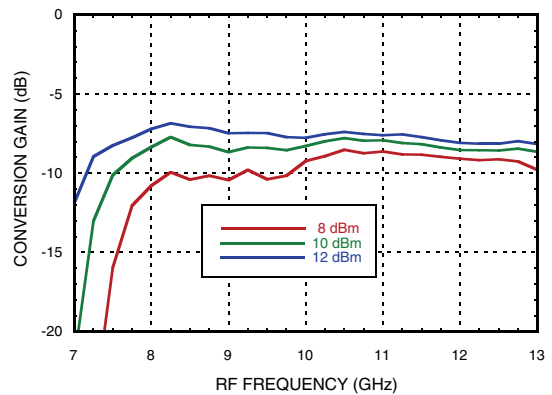

**Image Rejection, USB vs. Temperature**

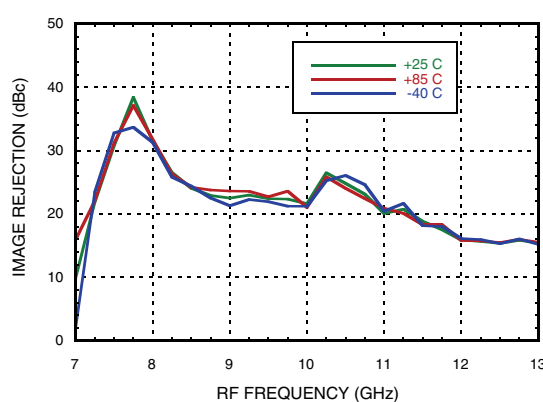

**Image Rejection, USB vs. LO Drive**

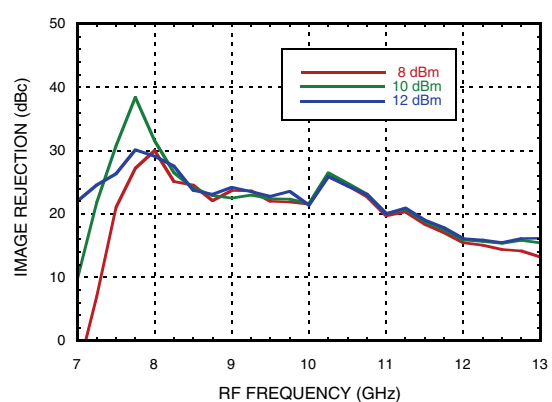

Information furnished by Analog Devices is believed to be accurate and reliable. However, no responsibility is assumed by Analog Devices for its use, nor for any infringements of patents or other rights of third parties that may result from its use. Specifications subject to change without notice. No license is granted by implication or otherwise under any patent or patent rights of Analog Devices. Trademarks and registered trademarks are the property of their respective owners.

For price, delivery, and to place orders: Analog Devices, Inc., One Technology Way, P.O. Box 9106, Norwood, MA 02062-9106 Phone: 781-329-4700 • Order online at [www.analog.com](http://www.analog.com) Application Support: Phone: 1-800-ANALOG-D



**GaAs MMIC I/Q Mixer  
8 - 12 GHz**

**Data Taken as SSB Downconverter with External IF 90° Hybrid, IF = 100 MHz**

**Input P1dB, USB vs. Temperature**

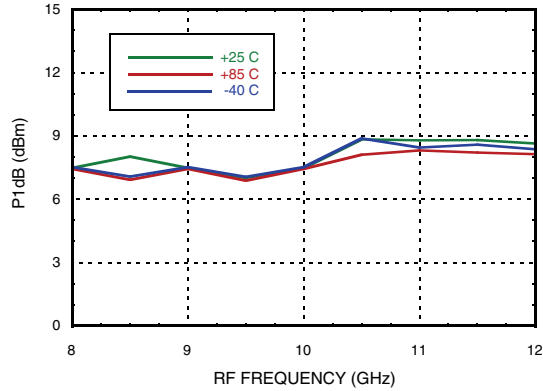

**Input IP3, USB vs. Temperature**

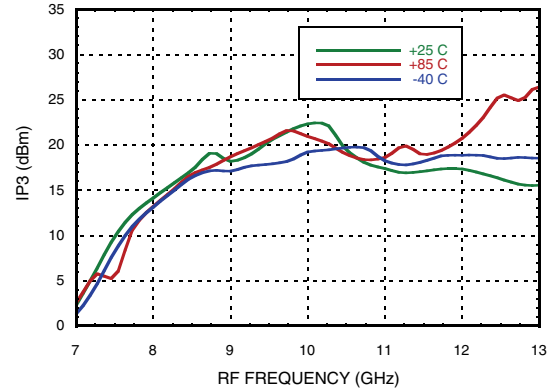

**Input IP3, USB vs. LO Drive**

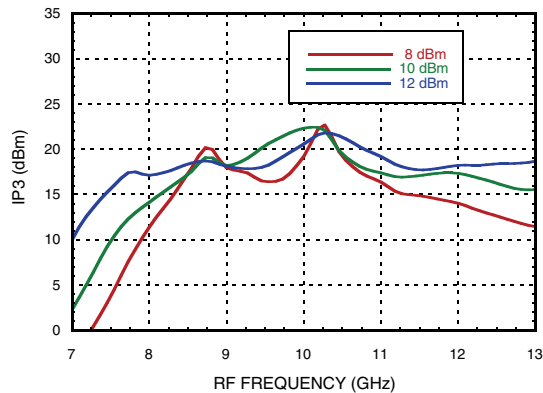

**Amplitude Balance, USB vs. LO Drive**

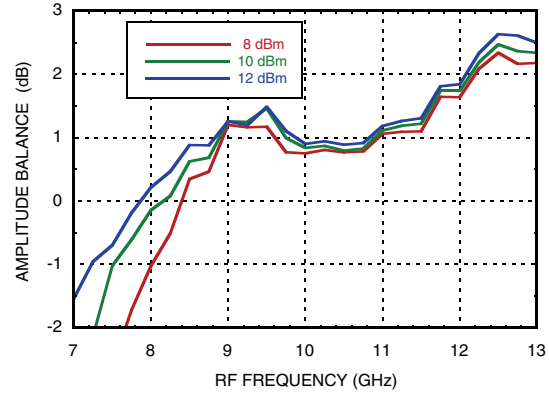

**Phase Balance, USB vs. LO Drive**

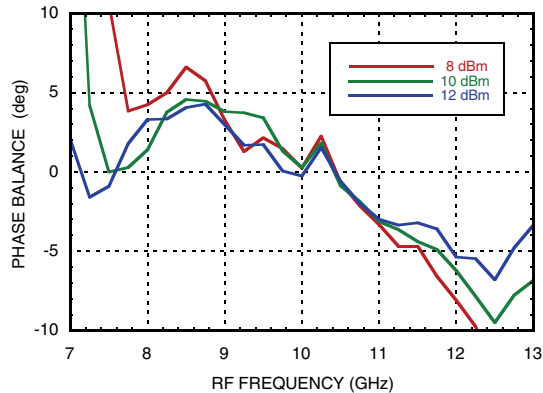

**Upconverter Performance, Conversion Gain, USB vs. LO Drive**

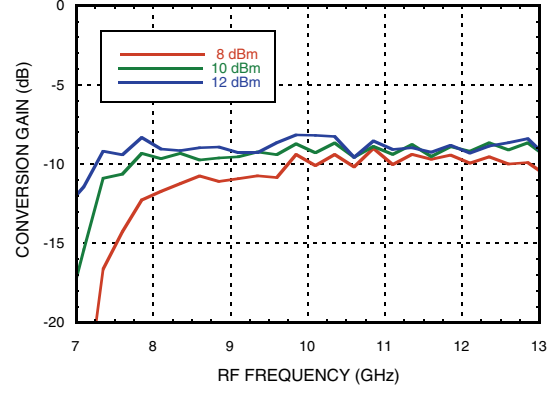

Information furnished by Analog Devices is believed to be accurate and reliable. However, no responsibility is assumed by Analog Devices for its use, nor for any infringements of patents or other rights of third parties that may result from its use. Specifications subject to change without notice. No license is granted by implication or otherwise under any patent or patent rights of Analog Devices. Trademarks and registered trademarks are the property of their respective owners.

For price, delivery, and to place orders: Analog Devices, Inc., One Technology Way, P.O. Box 9106, Norwood, MA 02062-9106  
Phone: 781-329-4700 • Order online at [www.analog.com](http://www.analog.com)  
Application Support: Phone: 1-800-ANALOG-D



**Data Taken as SSB Upconverter with External IF 90° Hybrid, IF = 100 MHz**

**Upconverter Performance, Sideband Rejection, USB vs. LO Drive,**

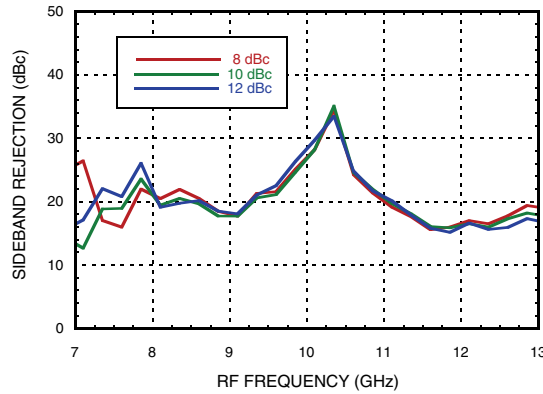



**GaAs MMIC I/Q Mixer  
8 - 12 GHz**

**Data Taken as SSB Downconverter with External IF 90° Hybrid, IF = 1000 MHz**

**Conversion Gain, LSB vs. Temperature**

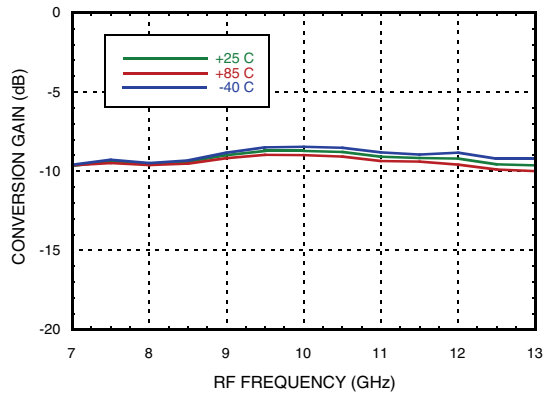

**Conversion Gain, LSB vs. LO Drive**

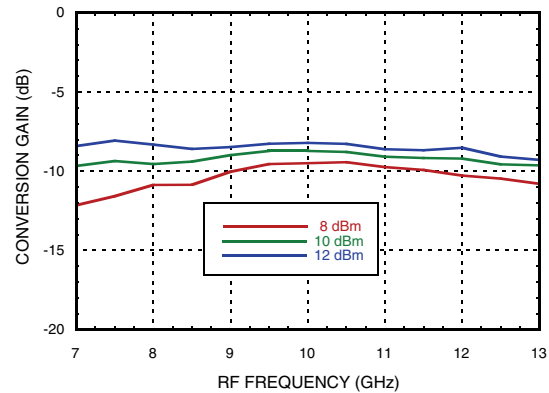

**Image Rejection, LSB vs. Temperature**

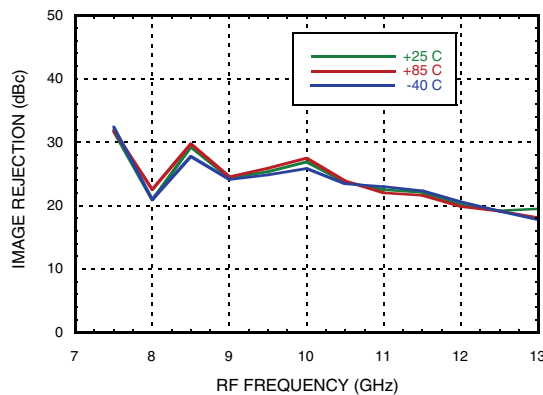

**Image Rejection, LSB vs. LO Drive**

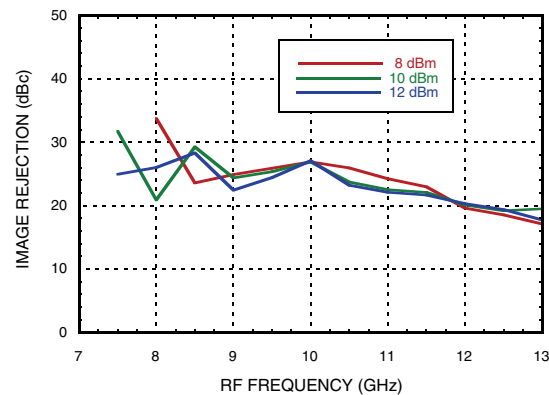

**Input IP3, LSB vs. Temperature**

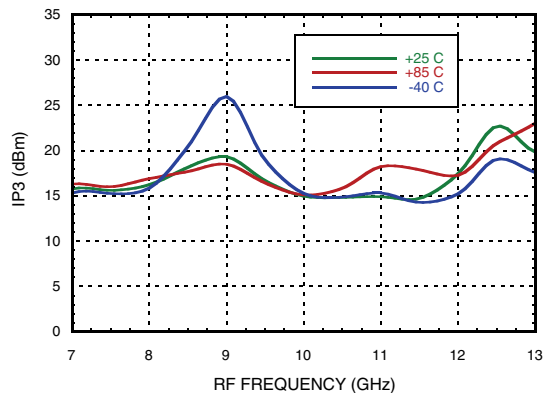

**Input IP3, LSB vs. LO Drive**

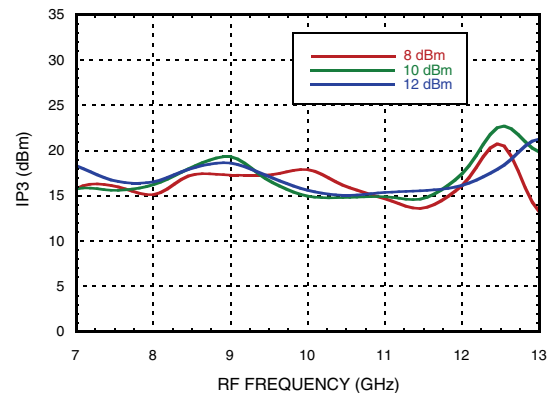

Information furnished by Analog Devices is believed to be accurate and reliable. However, no responsibility is assumed by Analog Devices for its use, nor for any infringements of patents or other rights of third parties that may result from its use. Specifications subject to change without notice. No license is granted by implication or otherwise under any patent or patent rights of Analog Devices. Trademarks and registered trademarks are the property of their respective owners.

For price, delivery, and to place orders: Analog Devices, Inc., One Technology Way, P.O. Box 9106, Norwood, MA 02062-9106 Phone: 781-329-4700 • Order online at [www.analog.com](http://www.analog.com) Application Support: Phone: 1-800-ANALOG-D



**GaAs MMIC I/Q Mixer  
8 - 12 GHz**

**Data Taken as SSB Downconverter with External IF 90° Hybrid, IF = 1000 MHz**

**Upconverter Performance, Conversion Gain, LSB vs. LO Drive**

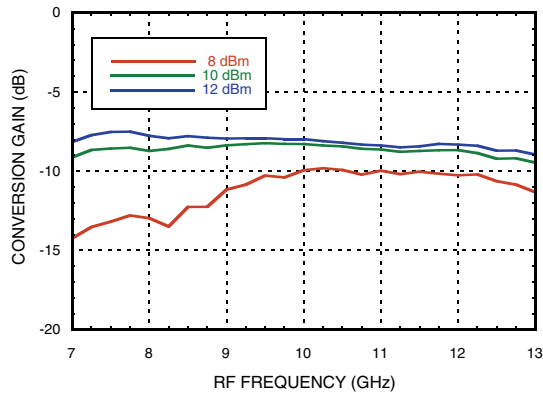

**Upconverter Performance, Sideband Rejection, LSB vs. LO Drive**

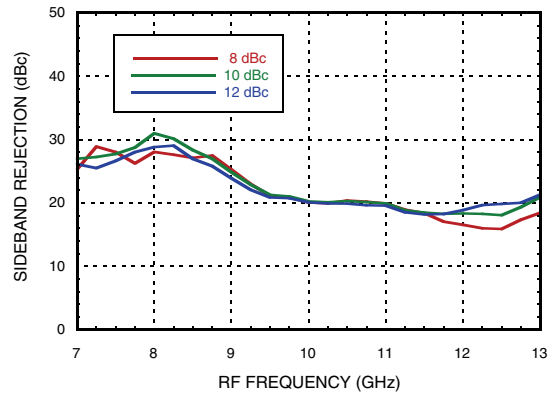

**Conversion Gain, USB vs. Temperature**

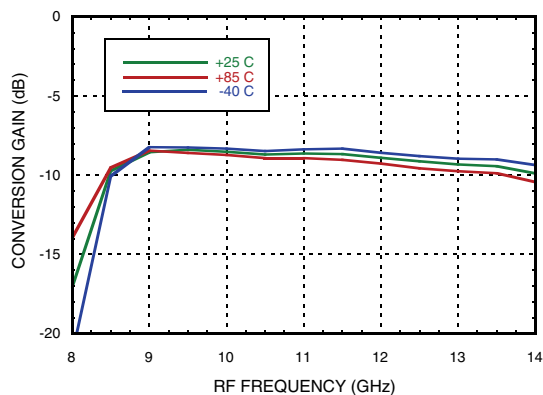

**Conversion Gain, USB vs. LO Drive**

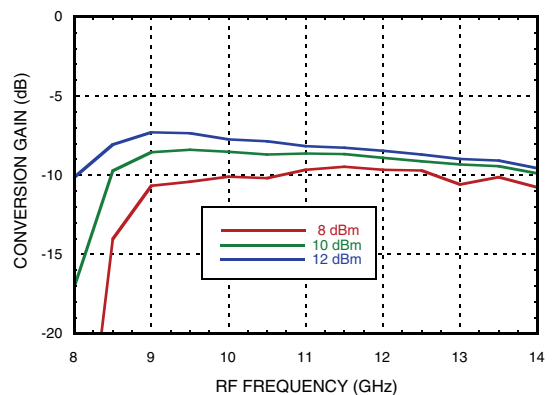

**Image Rejection, USB vs. Temperature**

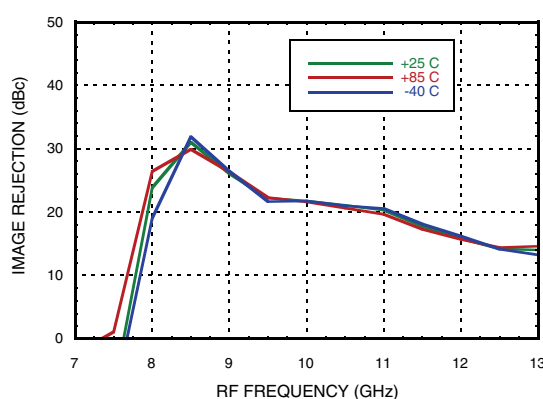

**Image Rejection, USB vs. LO Drive**

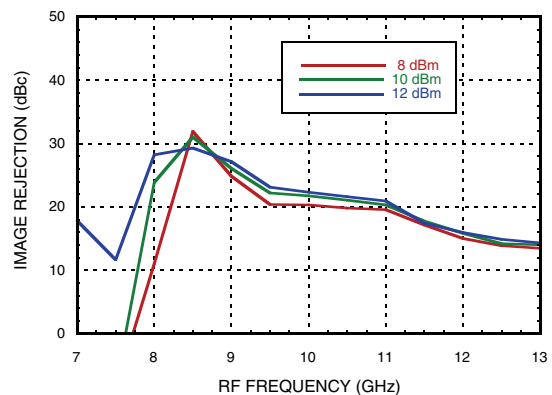

Information furnished by Analog Devices is believed to be accurate and reliable. However, no responsibility is assumed by Analog Devices for its use, nor for any infringements of patents or other rights of third parties that may result from its use. Specifications subject to change without notice. No license is granted by implication or otherwise under any patent or patent rights of Analog Devices. Trademarks and registered trademarks are the property of their respective owners.

For price, delivery, and to place orders: Analog Devices, Inc., One Technology Way, P.O. Box 9106, Norwood, MA 02062-9106 Phone: 781-329-4700 • Order online at [www.analog.com](http://www.analog.com) Application Support: Phone: 1-800-ANALOG-D





**GaAs MMIC I/Q Mixer  
8 - 12 GHz**

**Data Taken as SSB Downconverter with External IF 90° Hybrid, IF = 1000 MHz**

**Input IP3, USB vs. Temperature**

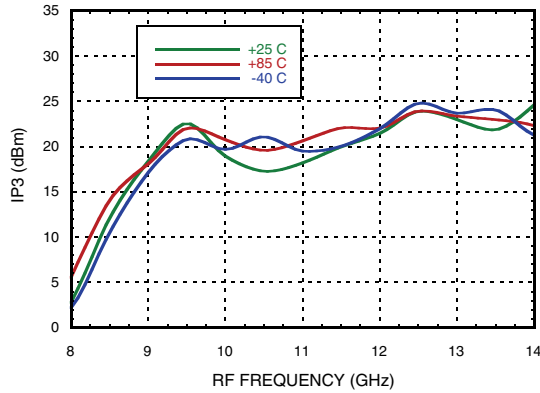

**Input IP3, USB vs. LO Drive**

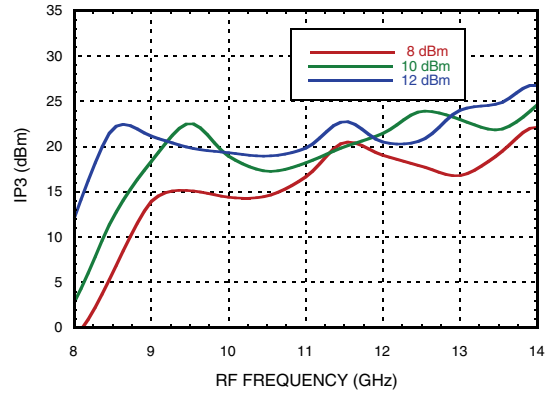

**Upconverter Performance, Conversion Gain, USB vs. LO Drive**

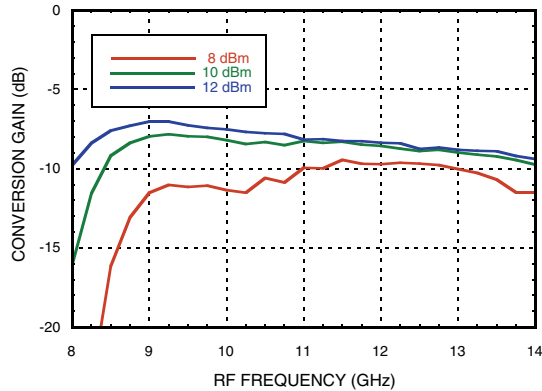

**Upconverter Performance, Sideband Rejection, USB vs. LO Drive**

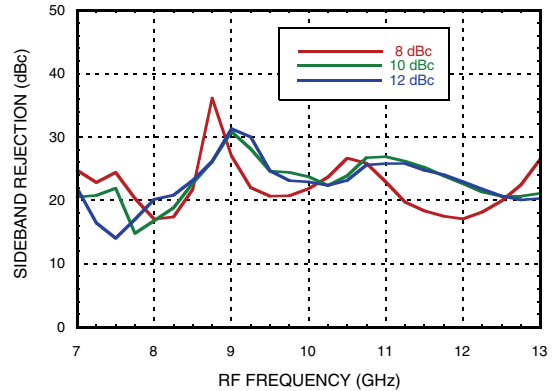



**Data Taken as SSB Downconverter with External IF 90° Hybrid, IF = 2000 MHz**

**Conversion Gain, LSB vs. Temperature**

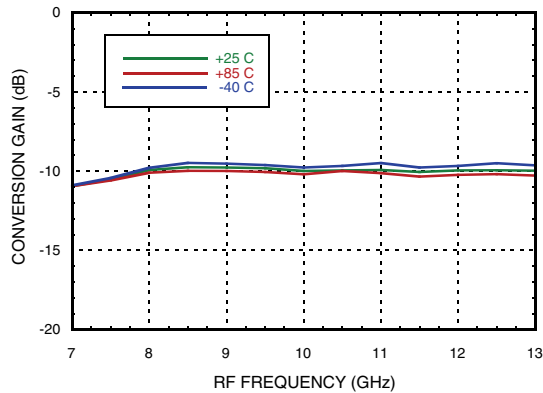

**Conversion Gain, LSB vs. LO Drive**

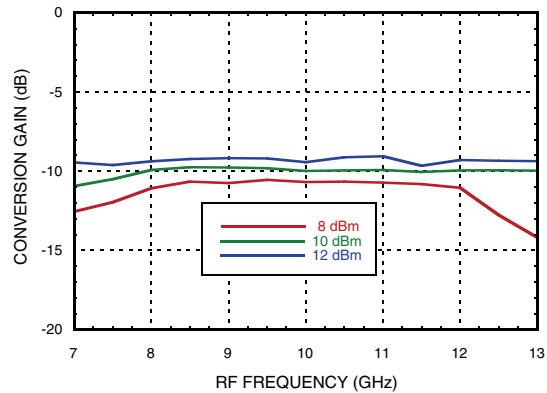

**Image Rejection, LSB vs. Temperature**

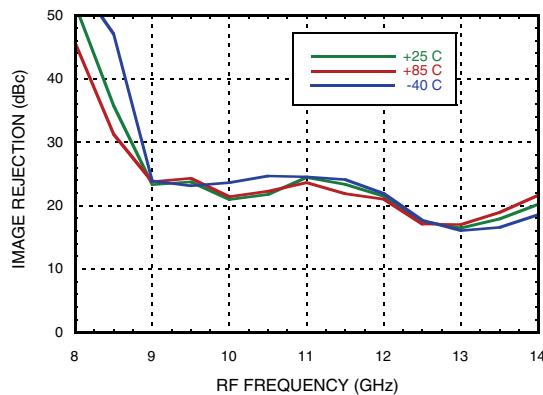

**Image Rejection, LSB vs. LO Drive**

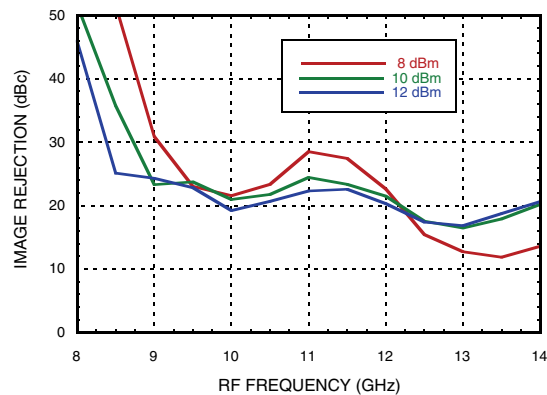

**Input IP3, LSB vs. Temperature**

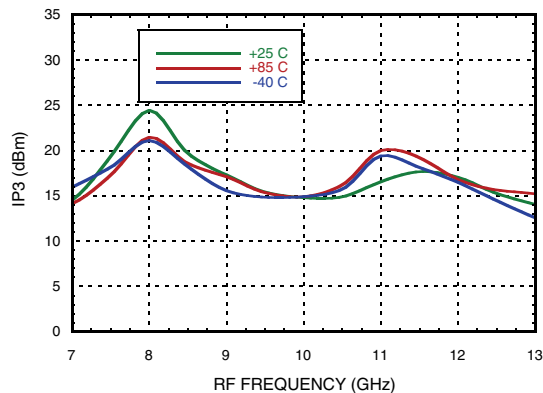

**Input IP3, LSB vs. LO Drive**

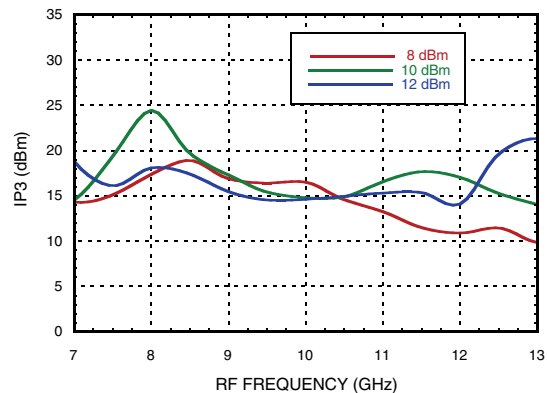

Information furnished by Analog Devices is believed to be accurate and reliable. However, no responsibility is assumed by Analog Devices for its use, nor for any infringements of patents or other rights of third parties that may result from its use. Specifications subject to change without notice. No license is granted by implication or otherwise under any patent or patent rights of Analog Devices. Trademarks and registered trademarks are the property of their respective owners.

For price, delivery, and to place orders: Analog Devices, Inc., One Technology Way, P.O. Box 9106, Norwood, MA 02062-9106 Phone: 781-329-4700 • Order online at [www.analog.com](http://www.analog.com) Application Support: Phone: 1-800-ANALOG-D



**GaAs MMIC I/Q Mixer  
8 - 12 GHz**

**Data Taken as SSB Downconverter with External IF 90° Hybrid, IF = 2000 MHz**

**Upconverter Performance, Conversion Gain, LSB vs. LO Drive**

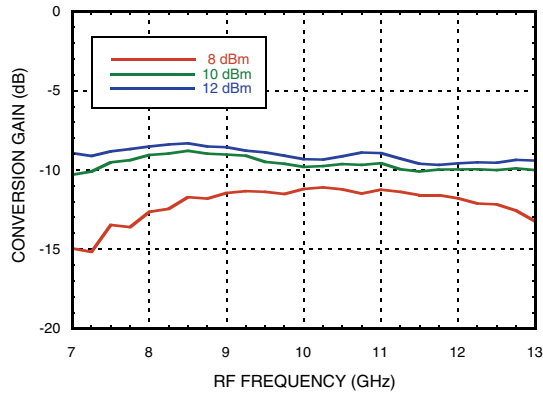

**Upconverter Performance, Sideband Rejection, LSB vs. LO Drive,**

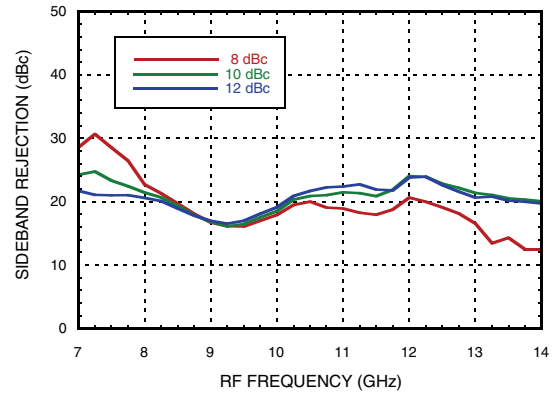

**Conversion Gain, USB vs. Temperature**

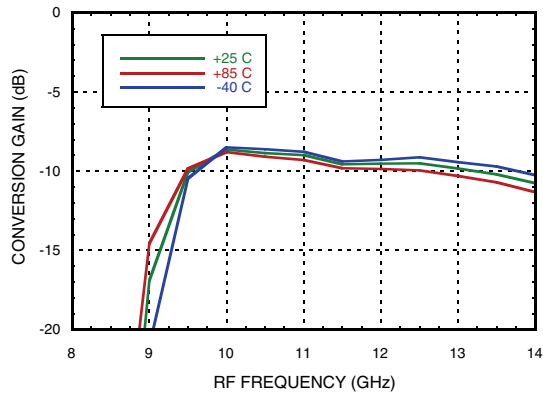

**Conversion Gain, USB vs. LO Drive**

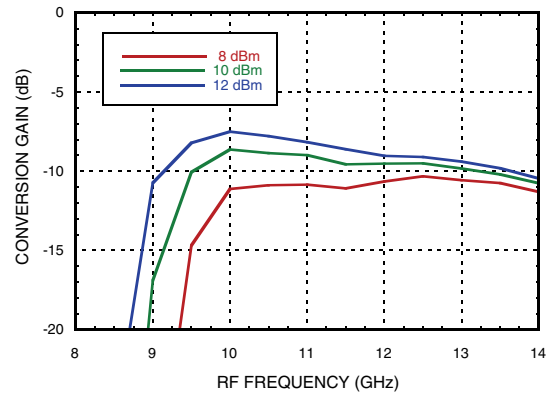

**Image Rejection, USB vs. Temperature**

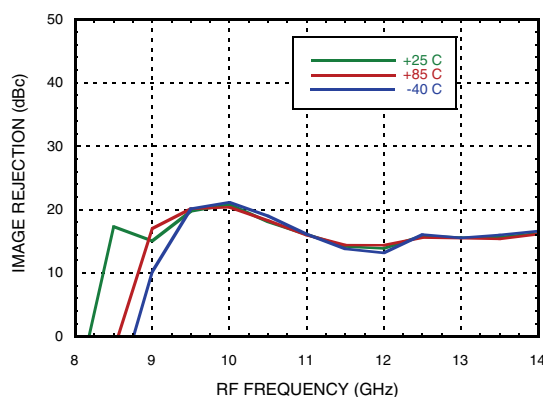

**Image Rejection, USB vs. LO Drive**

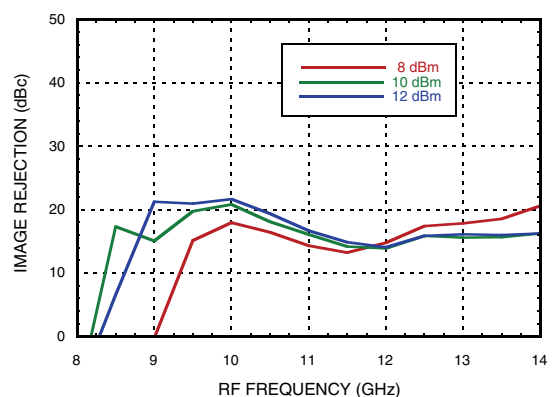

Information furnished by Analog Devices is believed to be accurate and reliable. However, no responsibility is assumed by Analog Devices for its use, nor for any infringements of patents or other rights of third parties that may result from its use. Specifications subject to change without notice. No license is granted by implication or otherwise under any patent or patent rights of Analog Devices. Trademarks and registered trademarks are the property of their respective owners.

For price, delivery, and to place orders: Analog Devices, Inc., One Technology Way, P.O. Box 9106, Norwood, MA 02062-9106 Phone: 781-329-4700 • Order online at [www.analog.com](http://www.analog.com) Application Support: Phone: 1-800-ANALOG-D



### Input IP3, USB vs. Temperature

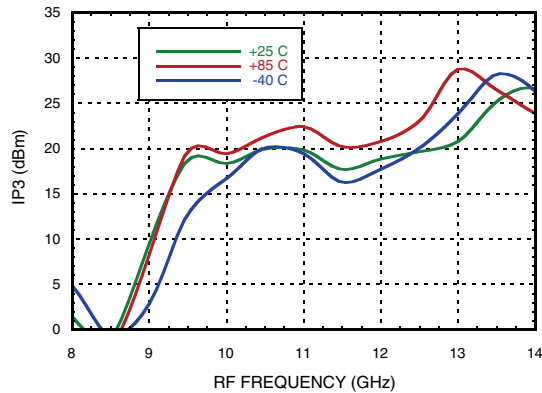

### Input IP3, USB vs. LO Drive

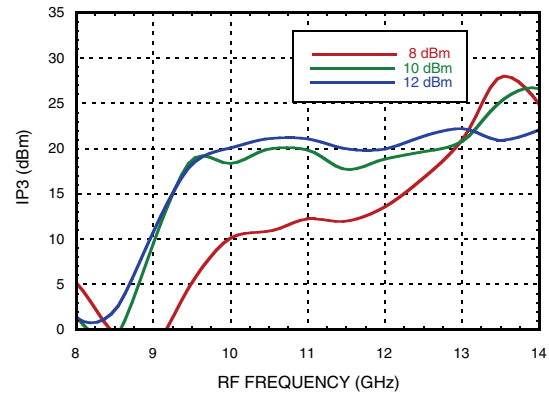

### Upconverter Performance, Conversion Gain, USB vs. LO Drive

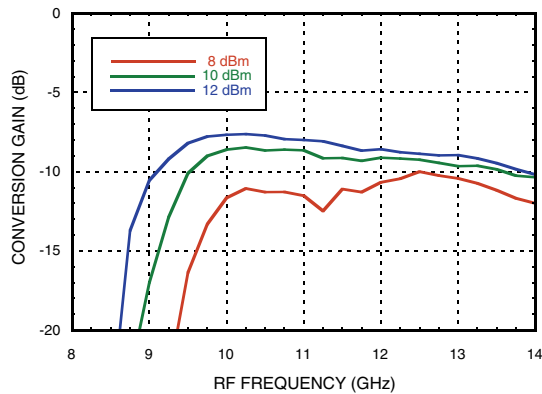

### Upconverter Performance, Sideband Rejection, USB vs. LO Drive

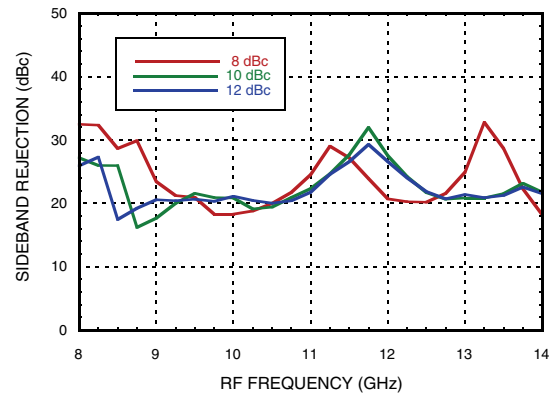

### Harmonics of LO

LO Freq. (GHz)	nLO Spur at RF Port			
	1	2	3	4
7	41.3	37.6	74.4	74.2
8	36.3	36.3	52	82.1
9	37.2	52.9	63.6	81.4
10	36.8	56.4	65.5	100.4
11	37.3	59.8	68.9	68.8
12	37.4	56.2	65.3	78.9
13	38.1	56.4	69.6	x

LO = + 10 dBm  
Values in dBc below LO level measured at RF Port.

### MxN Spurious Outputs

mRF	nLO				
	0	1	2	3	4
0	xx	8	38	48	60
1	8	0	28	43	60
2	64	50	56	48	67
3	94	78	67	64	78
4	x	x	x	x	x

RF = 10 GHz @ -10 dBm  
LO = 10.1 GHz @ +10 dBm  
Data taken without IF hybrid  
All values in dBc below IF power level



### Absolute Maximum Ratings

IF Input (At LO = 10 dBm and RF = -10 dBm)	+15.5 dBm
RF Input (At 10 dBm LO power)	+16 dBm
LO Input (At -10 dBm RF power)	+17 dBm
Channel Temperature	175 °C
Continuous P <sub>diss</sub> (T = 85°C) (derate 8.9 mW/°C above 85°C)	800 mW
Thermal Resistance (channel to ground paddle)	112 °C/W
Storage Temperature	-65 to +150 °C
Operating Temperature	-40 to +85 °C
ESD Sensitivity (HBM)	Class 0, Passed 150V



**ELECTROSTATIC SENSITIVE DEVICE  
OBSERVE HANDLING PRECAUTIONS**

### Outline Drawing

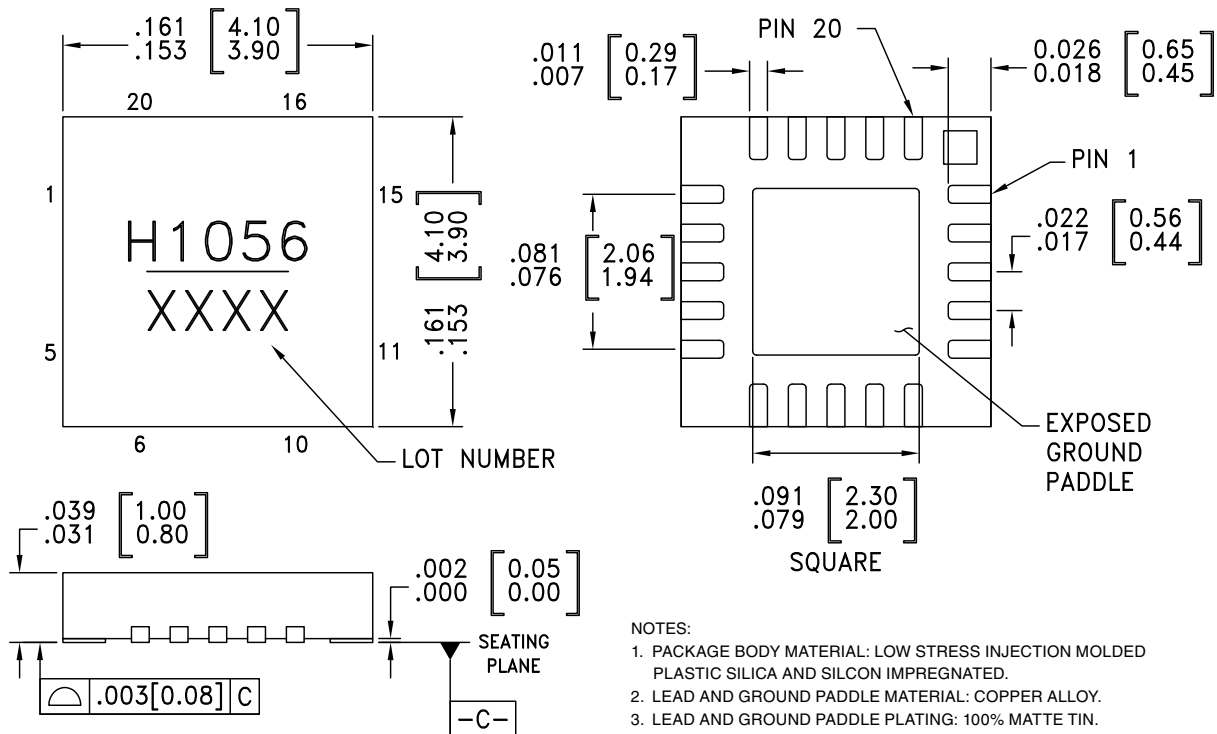

**NOTES:**

1. PACKAGE BODY MATERIAL: LOW STRESS INJECTION MOLDED PLASTIC SILICA AND SILICON IMPREGNATED.
2. LEAD AND GROUND PADDLE MATERIAL: COPPER ALLOY.
3. LEAD AND GROUND PADDLE PLATING: 100% MATTE TIN.
4. DIMENSIONS ARE IN INCHES [MILLIMETERS].
5. LEAD SPACING TOLERANCE IS NON-CUMULATIVE.
6. PAD BURR LENGTH SHALL BE 0.15mm MAX. PAD BURR HEIGHT SHALL BE 0.05mm MAX.
7. PACKAGE WARP SHALL NOT EXCEED 0.05mm.
8. ALL GROUND LEADS AND GROUND PADDLE MUST BE SOLDERED TO PCB RF GROUND.

### Package Information



Part Number	Package Body Material	Lead Finish	MSL Rating [2]	Package Marking [1]
HMC1056LP4BE	RoHS-compliant Low Stress Injection Molded Plastic	100% matte Sn	MSL1	H1056 XXXX

[1] 4-Digit lot number XXXX

[2] Max peak reflow temperature of 260 °C

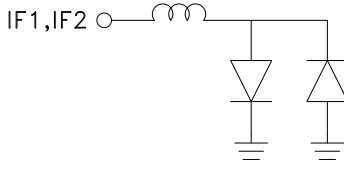
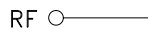

### Pin Descriptions

Pin Number	Function	Description	Interface Schematic
1, 5-8, 10-12, 16, 18-20	N/C	These pins are not connected internally; however, all data shown herein was measured with these pins connected to RF/DC ground externally.	
2, 4, 13, 15	GND	These pins and the exposed ground paddle must be connected to RF/DC ground.	
3	LO	This pin is AC coupled and matched to 50 Ohms .	
9	IF2	Differential IF input pins. For applications not requiring operation to DC, an off chip DC blocking capacitor should be used. For operation to DC this pin must not source/sink more than 3mA of current or part non function and possible part failure will result.	
17	IF1		
14	RF	This pin is matched to 50 Ohms.	



**Evaluation PCB**

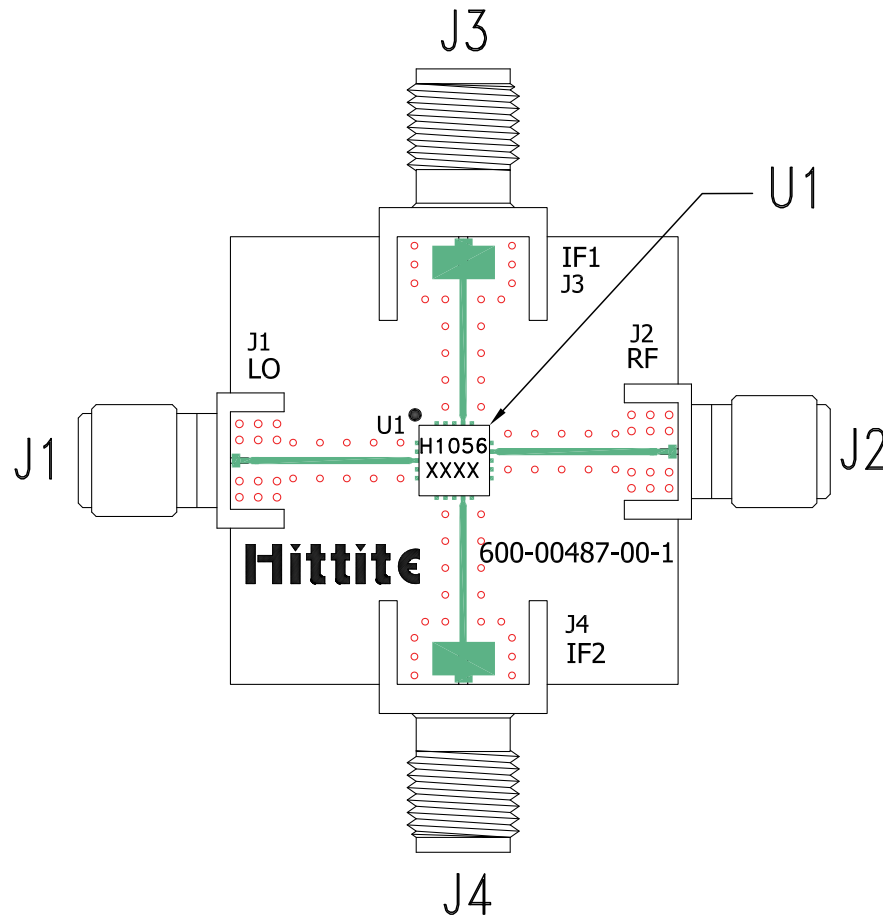

**List of Materials for Evaluation PCB EVAL01-HMC1056LP4B<sup>[1]</sup>**

Item	Description
J1, J2	PCB Mount SMA RF Connector, SRI
J3 - J4	PCB Mount SMA Connector, Johnson
U1	HMC1056LP4BE
PCB [2]	600-00487-00-1 Evaluation Board

[1] Reference this number when ordering complete evaluation PCB

[2] Circuit Board Material: Rogers 4350

The circuit board used in the application should use RF circuit design techniques. Signal lines should have 50 Ohm impedance while the package ground leads and exposed paddle should be connected directly to the ground plane similar to that shown. A sufficient number of via holes should be used to connect the top and bottom ground planes. The evaluation circuit board shown is available from Hittite upon request.

**Notes:**



Компания «Life Electronics» занимается поставками электронных компонентов импортного и отечественного производства от производителей и со складов крупных дистрибьюторов Европы, Америки и Азии.

С конца 2013 года компания активно расширяет линейку поставок компонентов по направлению коаксиальный кабель, кварцевые генераторы и конденсаторы (керамические, пленочные, электролитические), за счёт заключения дистрибьюторских договоров

Мы предлагаем:

- Конкурентоспособные цены и скидки постоянным клиентам.
- Специальные условия для постоянных клиентов.
- Подбор аналогов.
- Поставку компонентов в любых объемах, удовлетворяющих вашим потребностям.
- Приемлемые сроки поставки, возможна ускоренная поставка.
- Доставку товара в любую точку России и стран СНГ.
- Комплексную поставку.
- Работу по проектам и поставку образцов.
- Формирование склада под заказчика.
- Сертификаты соответствия на поставляемую продукцию (по желанию клиента).
- Тестирование поставляемой продукции.
- Поставку компонентов, требующих военную и космическую приемку.
- Входной контроль качества.
- Наличие сертификата ISO.

В составе нашей компании организован Конструкторский отдел, призванный помогать разработчикам, и инженерам.

Конструкторский отдел помогает осуществить:

- Регистрацию проекта у производителя компонентов.
- Техническую поддержку проекта.
- Защиту от снятия компонента с производства.
- Оценку стоимости проекта по компонентам.
- Изготовление тестовой платы монтаж и пусконаладочные работы.



Тел: +7 (812) 336 43 04 (многоканальный)

Email: [org@lifeelectronics.ru](mailto:org@lifeelectronics.ru)