



BCV62

PNP general-purpose double transistors

Rev. 4 — 26 July 2010

Product data sheet

1. Product profile

1.1 General description

PNP general-purpose double transistors in a small SOT143B Surface-Mounted Device (SMD) plastic package.

Table 1. Product overview

Type number	Package		NPN complement
	NXP	JEITA	
BCV62	SOT143B	-	BCV61
BCV62A			BCV61A
BCV62B			BCV61B
BCV62C			BCV61C

1.2 Features and benefits

- Low current (max. 100 mA)
- Low voltage (max. 30 V)
- Matched pairs
- AEC-Q101 qualified
- Small SMD plastic package

1.3 Applications

- Applications with working point independent of temperature
- Current mirrors

1.4 Quick reference data

Table 2. Quick reference data

Symbol	Parameter	Conditions	Min	Typ	Max	Unit
Per transistor						
V_{CE0}	collector-emitter voltage	open base	-	-	-30	V
I_C	collector current		-	-	-100	mA
Transistor TR1						
h_{FE}	DC current gain	$V_{CE} = -5\text{ V}; I_C = -100\ \mu\text{A}$	100	-	-	
		$V_{CE} = -5\text{ V}; I_C = -2\text{ mA}$	100	-	800	

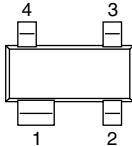
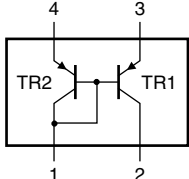

Table 2. Quick reference data ...continued

Symbol	Parameter	Conditions	Min	Typ	Max	Unit
Transistor TR2						
h_{FE}	DC current gain	$V_{CE} = -5\text{ V}; I_C = -2\text{ mA}$				
	BCV62		100	-	800	
	BCV62A		100	-	250	
	BCV62B		220	-	475	
	BCV62C		420	-	800	

2. Pinning information

Table 3. Pinning

Pin	Description	Simplified outline	Graphic symbol
1	collector TR2; base TR1 and TR2		
2	collector TR1		
3	emitter TR1		
4	emitter TR2		

006aaa843

3. Ordering information

Table 4. Ordering information

Type number	Package		Version
	Name	Description	
BCV62	-	plastic surface-mounted package; 4 leads	SOT143B
BCV62A			
BCV62B			
BCV62C			

4. Marking

Table 5. Marking codes

Type number	Marking code ^[1]
BCV62	3M*
BCV62A	3J*
BCV62B	3K*
BCV62C	3L*

[1] * = -: made in Hong Kong
 * = p: made in Hong Kong
 * = t: made in Malaysia
 * = W: made in China

5. Limiting values

Table 6. Limiting values

In accordance with the Absolute Maximum Rating System (IEC 60134).

Symbol	Parameter	Conditions	Min	Max	Unit
Per transistor					
V_{CBO}	collector-base voltage	open emitter	-	-30	V
V_{CEO}	collector-emitter voltage	open base	-	-30	V
V_{EBS}	emitter-base voltage	$V_{CE} = 0$ V	-	-6	V
I_C	collector current		-	-100	mA
I_{CM}	peak collector current		-	-200	mA
I_{BM}	peak base current		-	-200	mA
Per device					
P_{tot}	total power dissipation	$T_{amb} \leq 25$ °C	[1]	250	mW
T_j	junction temperature		-	150	°C
T_{amb}	ambient temperature		-65	+150	°C
T_{stg}	storage temperature		-65	+150	°C

[1] Device mounted on an FR4 Printed-Circuit Board (PCB).

6. Thermal characteristics

Table 7. Thermal characteristics

Symbol	Parameter	Conditions	Min	Typ	Max	Unit
$R_{th(j-a)}$	thermal resistance from junction to ambient	in free air	[1]	-	500	K/W

[1] Device mounted on an FR4 PCB.

7. Characteristics

Table 8. Characteristics

$T_j = 25$ °C unless otherwise specified.

Symbol	Parameter	Conditions	Min	Typ	Max	Unit
Transistor TR1						
I_{CBO}	collector-base cut-off current	$V_{CB} = -30$ V; $I_E = 0$ A	-	-	-15	nA
		$V_{CB} = -30$ V; $I_E = 0$ A; $T_j = 150$ °C	-	-	-5	μA
I_{EBO}	emitter-base cut-off current	$V_{EB} = -5$ V; $I_C = 0$ A	-	-	-100	nA
h_{FE}	DC current gain	$V_{CE} = -5$ V; $I_C = -100$ μA	100	-	-	
		$V_{CE} = -5$ V; $I_C = -2$ mA	100	-	800	
V_{CEsat}	collector-emitter saturation voltage	$I_C = -10$ mA; $I_B = -0.5$ mA	-	-75	-300	mV
		$I_C = -100$ mA; $I_B = -5$ mA	-	-250	-650	mV

Table 8. Characteristics ...continued
 $T_j = 25\text{ °C}$ unless otherwise specified.

Symbol	Parameter	Conditions	Min	Typ	Max	Unit		
V_{BEsat}	base-emitter saturation voltage	$I_C = -10\text{ mA};$ $I_B = -0.5\text{ mA}$	[1]	-	-700	-	mV	
		$I_C = -100\text{ mA};$ $I_B = -5\text{ mA}$	[1]	-	-850	-	mV	
V_{BE}	base-emitter voltage	$I_C = -2\text{ mA}; V_{CE} = -5\text{ V}$	[2]	-600	-650	-750	mV	
		$I_C = -10\text{ mA}; V_{CE} = -5\text{ V}$	[2]	-	-	-820	mV	
f_T	transition frequency	$V_{CE} = -5\text{ V};$ $I_C = -10\text{ mA};$ $f = 100\text{ MHz}$		100	-	-	MHz	
C_c	collector capacitance	$V_{CB} = -10\text{ V};$ $I_E = i_e = 0\text{ A}$		-	4.5	-	pF	
NF	noise figure	$V_{CE} = -5\text{ V};$ $I_C = -200\text{ }\mu\text{A}; R_S = 2\text{ k}\Omega;$ $f = 1\text{ kHz}; B = 200\text{ Hz}$		-	-	10	dB	
Transistor TR2								
V_{EBS}	emitter-base voltage	$V_{CB} = 0\text{ V}; I_E = -250\text{ mA}$		-	-	-1.5	V	
		$V_{CB} = 0\text{ V}; I_E = -10\text{ }\mu\text{A}$		-400	-	-	mV	
h_{FE}	DC current gain	$V_{CE} = -5\text{ V}; I_C = -2\text{ mA}$						
			BCV62		100	-	800	
			BCV62A		100	-	250	
			BCV62B		220	-	475	
	BCV62C		420	-	800			
Transistors TR1 and TR2								
I_{C1}/I_{E2}	current matching	$I_{E2} = -0.5\text{ mA};$ $V_{CE1} = -5\text{ V};$						
			$T_{amb} \leq 25\text{ °C}$		0.7	-	1.3	
			$T_{amb} \leq 150\text{ °C}$		0.7	-	1.3	
I_{E2}	emitter current 2	$V_{CE1} = -5\text{ V}$	[3]	-	-	-5	mA	

[1] V_{BEsat} decreases by about 1.7 mV/K with increasing temperature.

[2] V_{BE} decreases by about 2 mV/K with increasing temperature.

[3] Device, without emitter resistors, mounted on an FR4 PCB.

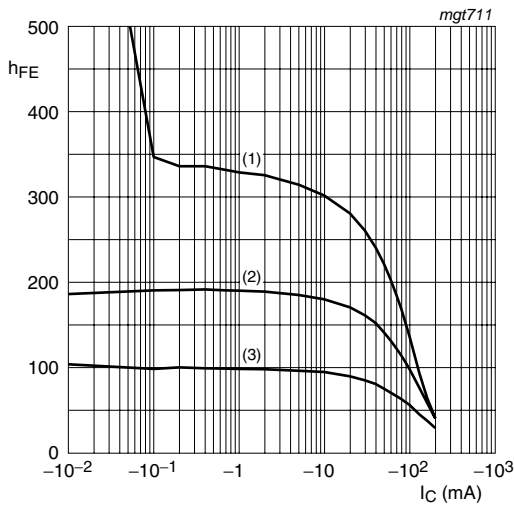

$V_{CE} = -5\text{ V}$
 (1) $T_{amb} = 150\text{ °C}$
 (2) $T_{amb} = 25\text{ °C}$
 (3) $T_{amb} = -55\text{ °C}$

Fig 1. BCV62A: DC current gain as a function of collector current; typical values

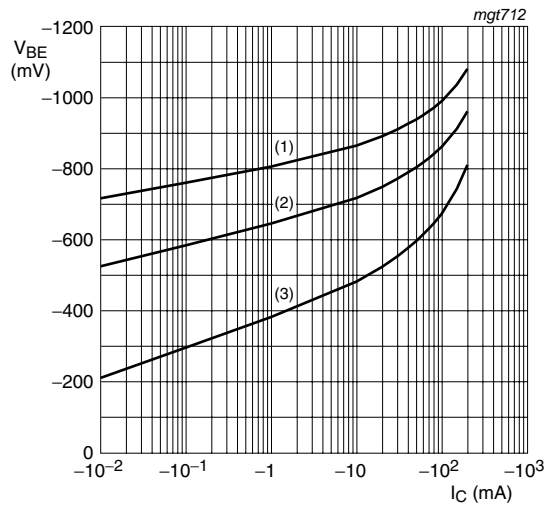

$V_{CE} = -5\text{ V}$
 (1) $T_{amb} = -55\text{ °C}$
 (2) $T_{amb} = 25\text{ °C}$
 (3) $T_{amb} = 150\text{ °C}$

Fig 2. BCV62A: Base-emitter voltage as a function of collector current; typical values

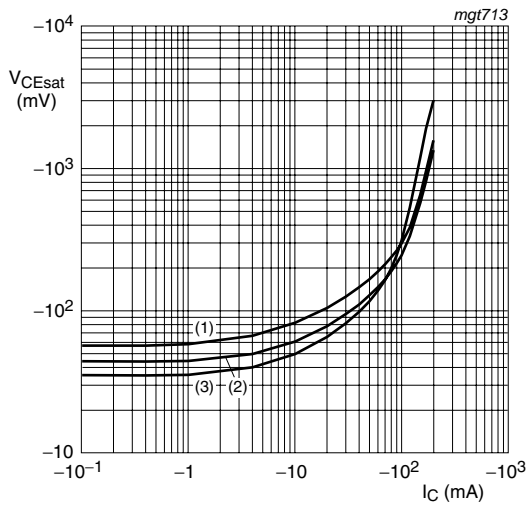

$I_C/I_B = 20$
 (1) $T_{amb} = 150\text{ °C}$
 (2) $T_{amb} = 25\text{ °C}$
 (3) $T_{amb} = -55\text{ °C}$

Fig 3. BCV62A: Collector-emitter saturation voltage as a function of collector current; typical values

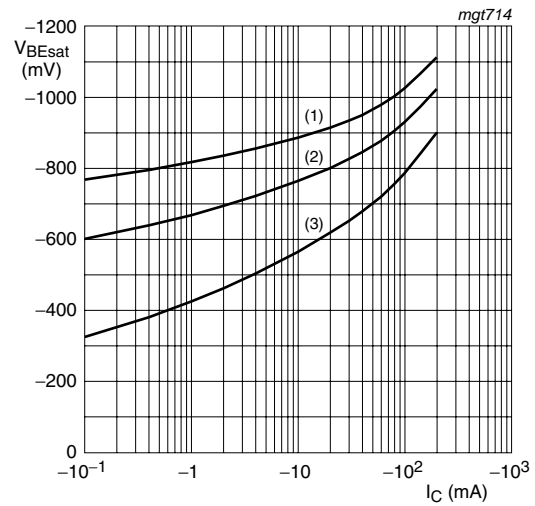

$I_C/I_B = 20$
 (1) $T_{amb} = -55\text{ °C}$
 (2) $T_{amb} = 25\text{ °C}$
 (3) $T_{amb} = 150\text{ °C}$

Fig 4. BCV62A: Base-emitter saturation voltage as a function of collector current; typical values

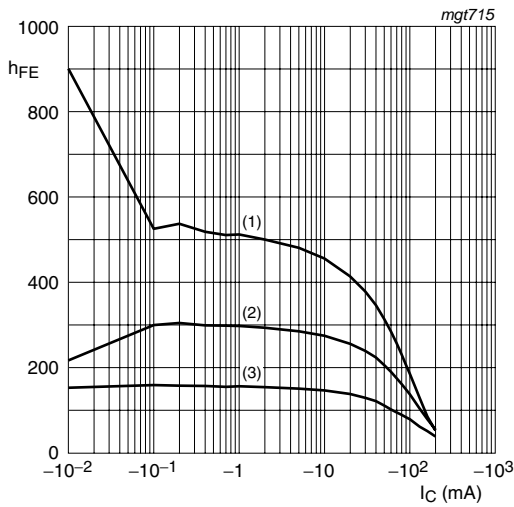

$V_{CE} = -5\text{ V}$
 (1) $T_{amb} = 150\text{ }^{\circ}\text{C}$
 (2) $T_{amb} = 25\text{ }^{\circ}\text{C}$
 (3) $T_{amb} = -55\text{ }^{\circ}\text{C}$

Fig 5. BCV62B: DC current gain as a function of collector current; typical values

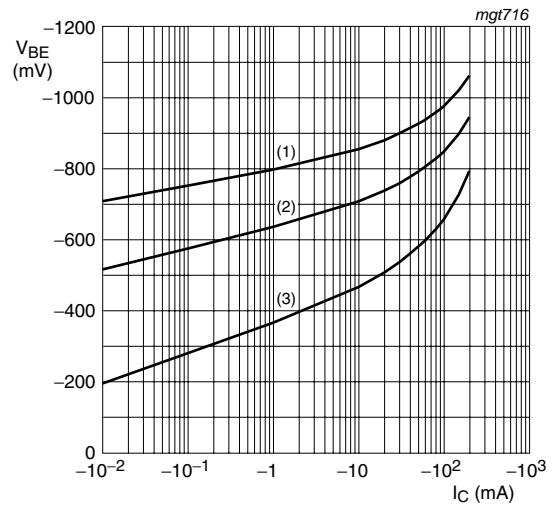

$V_{CE} = -5\text{ V}$
 (1) $T_{amb} = -55\text{ }^{\circ}\text{C}$
 (2) $T_{amb} = 25\text{ }^{\circ}\text{C}$
 (3) $T_{amb} = 150\text{ }^{\circ}\text{C}$

Fig 6. BCV62B: Base-emitter voltage as a function of collector current; typical values

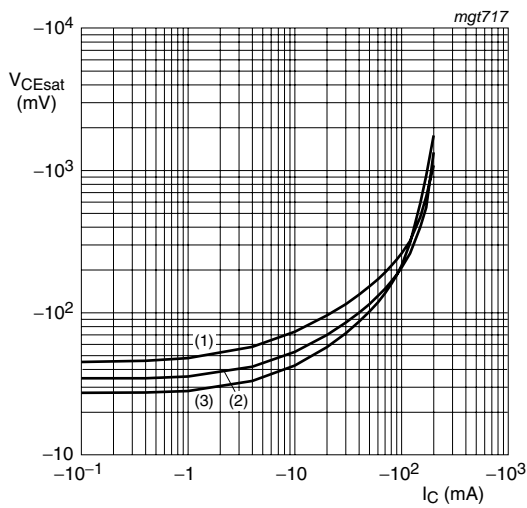

$I_C/I_B = 20$
 (1) $T_{amb} = 150\text{ }^{\circ}\text{C}$
 (2) $T_{amb} = 25\text{ }^{\circ}\text{C}$
 (3) $T_{amb} = -55\text{ }^{\circ}\text{C}$

Fig 7. BCV62B: Collector-emitter saturation voltage as a function of collector current; typical values

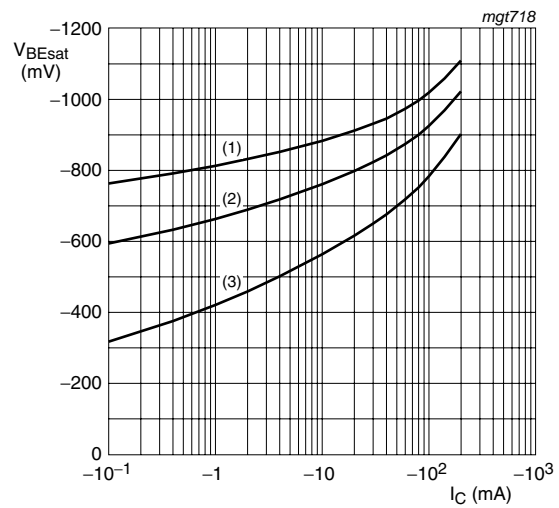

$I_C/I_B = 20$
 (1) $T_{amb} = -55\text{ }^{\circ}\text{C}$
 (2) $T_{amb} = 25\text{ }^{\circ}\text{C}$
 (3) $T_{amb} = 150\text{ }^{\circ}\text{C}$

Fig 8. BCV62B: Base-emitter saturation voltage as a function of collector current; typical values

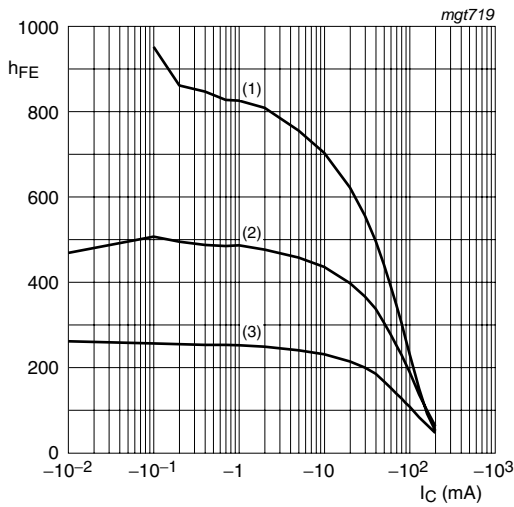

$V_{CE} = -5\text{ V}$
 (1) $T_{amb} = 150\text{ °C}$
 (2) $T_{amb} = 25\text{ °C}$
 (3) $T_{amb} = -55\text{ °C}$

Fig 9. BCV62C: DC current gain as a function of collector current; typical values

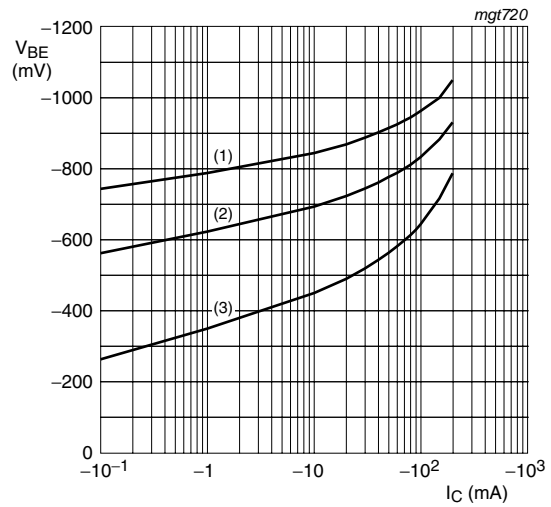

$V_{CE} = -5\text{ V}$
 (1) $T_{amb} = -55\text{ °C}$
 (2) $T_{amb} = 25\text{ °C}$
 (3) $T_{amb} = 150\text{ °C}$

Fig 10. BCV62C: Base-emitter voltage as a function of collector current; typical values

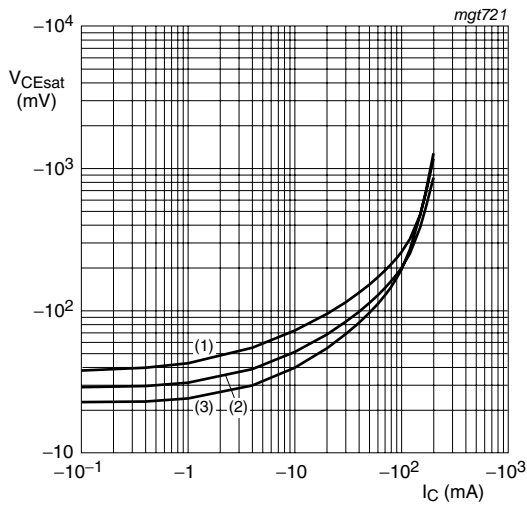

$I_C/I_B = 20$
 (1) $T_{amb} = 150\text{ °C}$
 (2) $T_{amb} = 25\text{ °C}$
 (3) $T_{amb} = -55\text{ °C}$

Fig 11. BCV62C: Collector-emitter saturation voltage as a function of collector current; typical values

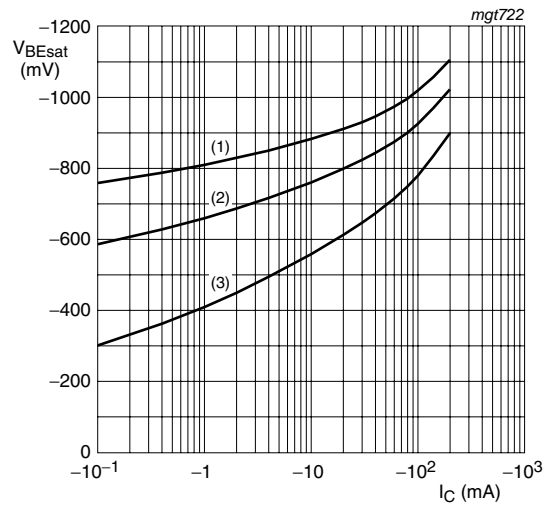

$I_C/I_B = 20$
 (1) $T_{amb} = -55\text{ °C}$
 (2) $T_{amb} = 25\text{ °C}$
 (3) $T_{amb} = 150\text{ °C}$

Fig 12. BCV62C: Base-emitter saturation voltage as a function of collector current; typical values

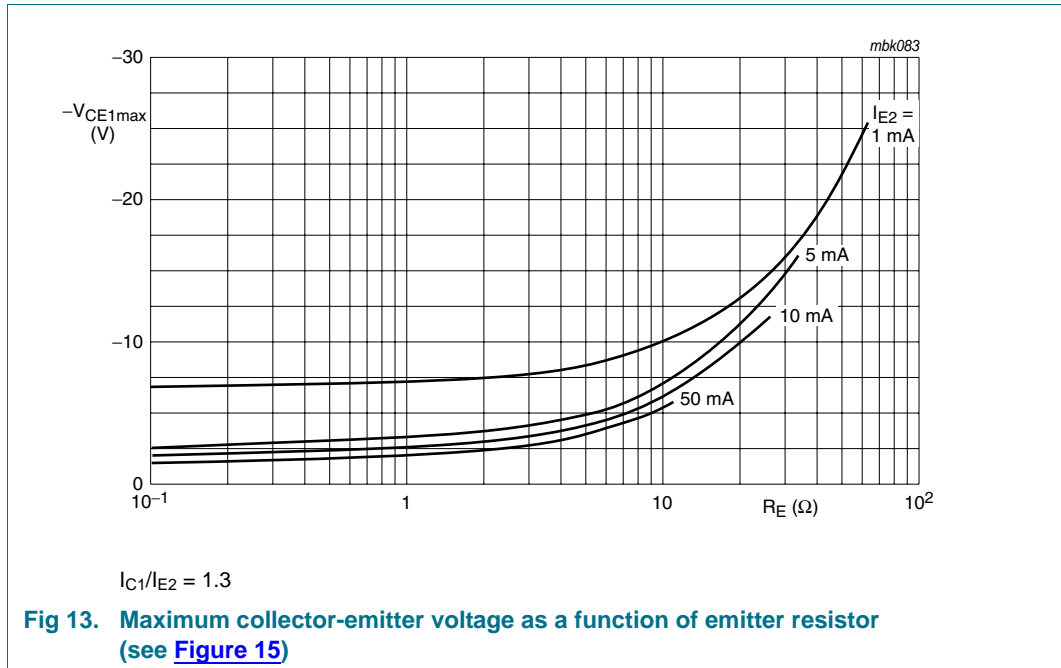

8. Test information

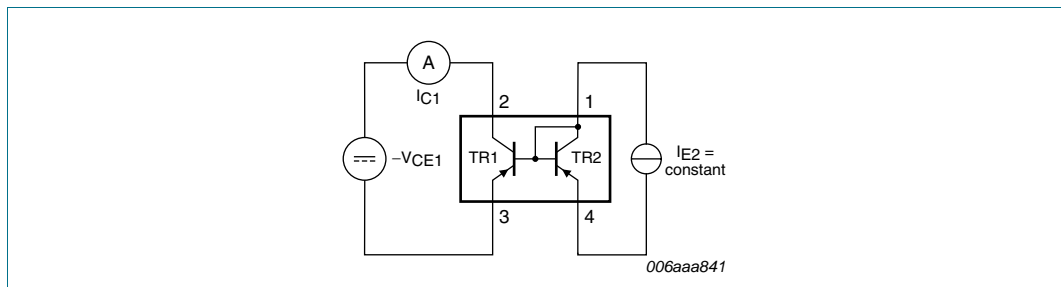

Fig 14. Test circuit current matching

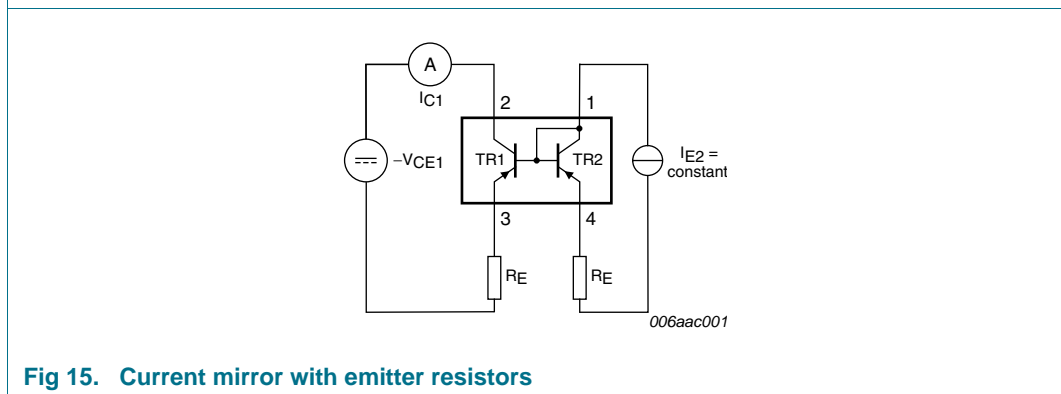

Fig 15. Current mirror with emitter resistors

8.1 Quality information

This product has been qualified in accordance with the Automotive Electronics Council (AEC) standard Q101 - Stress test qualification for discrete semiconductors, and is suitable for use in automotive applications.

9. Package outline

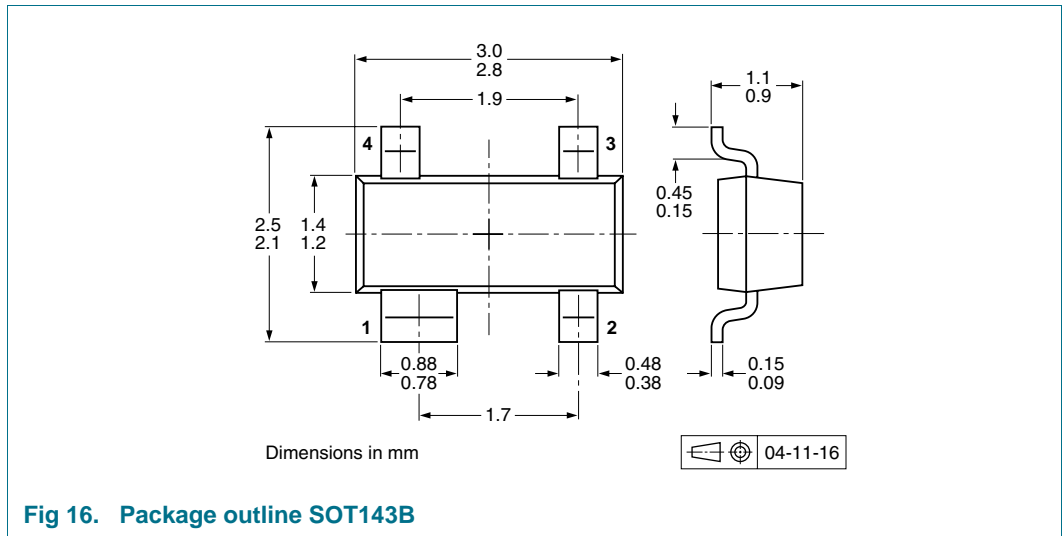

Fig 16. Package outline SOT143B

10. Packing information

Table 9. Packing methods

The indicated -xxx are the last three digits of the 12NC ordering code.^[1]

Type number	Package	Description	Packing quantity	
			3000	10000
BCV62	SOT143B	4 mm pitch, 8 mm tape and reel	-215	-235
BCV62A				
BCV62B				
BCV62C				

[1] For further information and the availability of packing methods, see Section 14.

11. Soldering

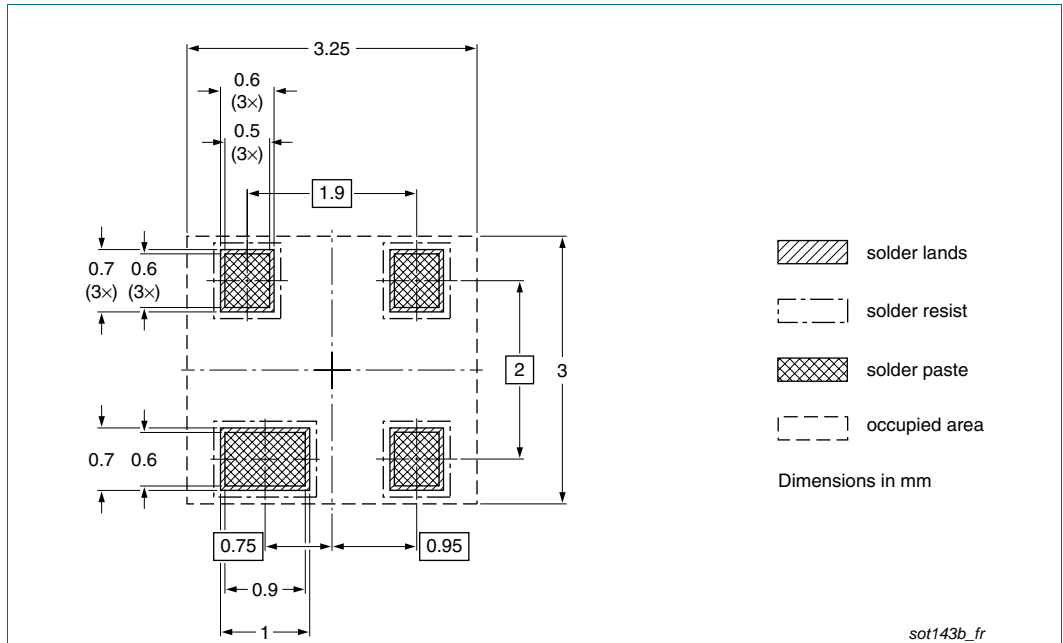

Fig 17. Reflow soldering footprint SOT143B

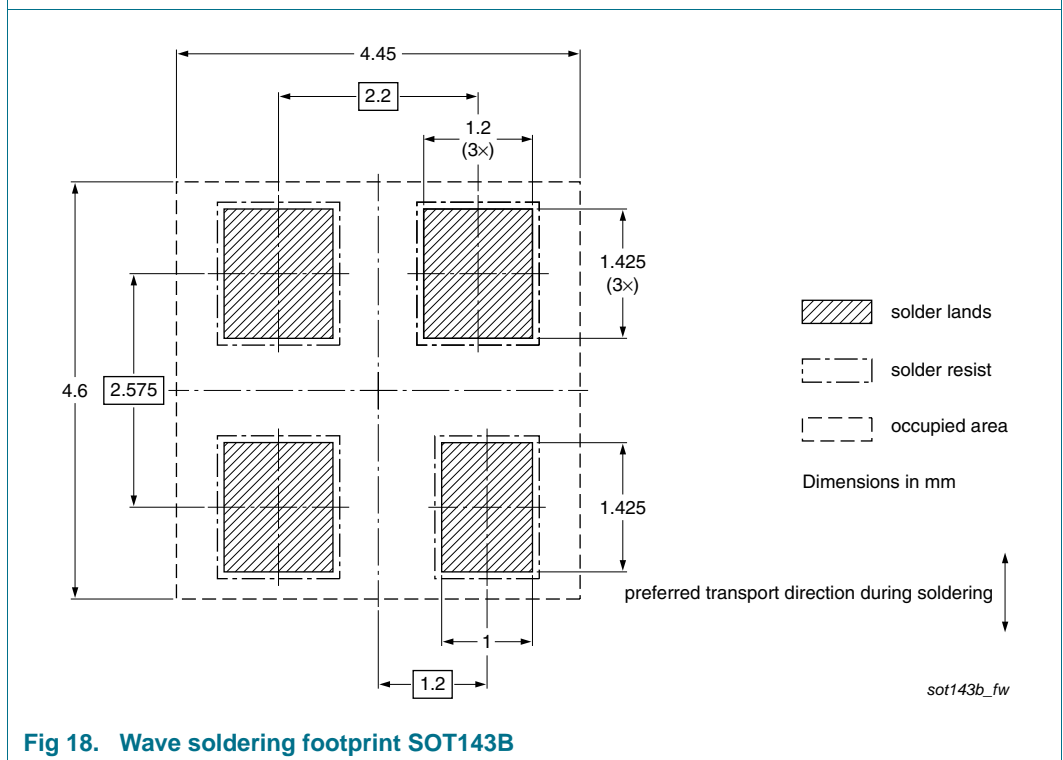

Fig 18. Wave soldering footprint SOT143B

12. Revision history

Table 10. Revision history

Document ID	Release date	Data sheet status	Change notice	Supersedes
BCV62 v.4	20100726	Product data sheet	-	BCV62_3
Modifications:		<ul style="list-style-type: none"> • The format of this data sheet has been redesigned to comply with the new identity guidelines of NXP Semiconductors. • Legal texts have been adapted to the new company name where appropriate. • Section 1 “Product profile”: amended • Section 3 “Ordering information”: added • Section 4 “Marking”: updated • Figure 1, 2, 3, 4, 5, 6, 7, 8, 9, 10, 11 and 12: added • Section 8 “Test information”: added • Figure 16: superseded by minimized package outline drawing • Section 10 “Packing information”: added • Section 11 “Soldering”: added • Section 13 “Legal information”: updated 		
BCV62_3	19990408	Product specification	-	BCV62_CNV_2
BCV62_CNV_2	19970618	Product specification	-	-

13. Legal information

13.1 Data sheet status

Document status ^{[1][2]}	Product status ^[3]	Definition
Objective [short] data sheet	Development	This document contains data from the objective specification for product development.
Preliminary [short] data sheet	Qualification	This document contains data from the preliminary specification.
Product [short] data sheet	Production	This document contains the product specification.

[1] Please consult the most recently issued document before initiating or completing a design.

[2] The term 'short data sheet' is explained in section "Definitions".

[3] The product status of device(s) described in this document may have changed since this document was published and may differ in case of multiple devices. The latest product status information is available on the Internet at URL <http://www.nxp.com>.

13.2 Definitions

Draft — The document is a draft version only. The content is still under internal review and subject to formal approval, which may result in modifications or additions. NXP Semiconductors does not give any representations or warranties as to the accuracy or completeness of information included herein and shall have no liability for the consequences of use of such information.

Short data sheet — A short data sheet is an extract from a full data sheet with the same product type number(s) and title. A short data sheet is intended for quick reference only and should not be relied upon to contain detailed and full information. For detailed and full information see the relevant full data sheet, which is available on request via the local NXP Semiconductors sales office. In case of any inconsistency or conflict with the short data sheet, the full data sheet shall prevail.

Product specification — The information and data provided in a Product data sheet shall define the specification of the product as agreed between NXP Semiconductors and its customer, unless NXP Semiconductors and customer have explicitly agreed otherwise in writing. In no event however, shall an agreement be valid in which the NXP Semiconductors product is deemed to offer functions and qualities beyond those described in the Product data sheet.

13.3 Disclaimers

Limited warranty and liability — Information in this document is believed to be accurate and reliable. However, NXP Semiconductors does not give any representations or warranties, expressed or implied, as to the accuracy or completeness of such information and shall have no liability for the consequences of use of such information.

In no event shall NXP Semiconductors be liable for any indirect, incidental, punitive, special or consequential damages (including - without limitation - lost profits, lost savings, business interruption, costs related to the removal or replacement of any products or rework charges) whether or not such damages are based on tort (including negligence), warranty, breach of contract or any other legal theory.

Notwithstanding any damages that customer might incur for any reason whatsoever, NXP Semiconductors' aggregate and cumulative liability towards customer for the products described herein shall be limited in accordance with the *Terms and conditions of commercial sale* of NXP Semiconductors.

Right to make changes — NXP Semiconductors reserves the right to make changes to information published in this document, including without limitation specifications and product descriptions, at any time and without notice. This document supersedes and replaces all information supplied prior to the publication hereof.

Suitability for use — NXP Semiconductors products are not designed, authorized or warranted to be suitable for use in life support, life-critical or safety-critical systems or equipment, nor in applications where failure or

malfunction of an NXP Semiconductors product can reasonably be expected to result in personal injury, death or severe property or environmental damage. NXP Semiconductors accepts no liability for inclusion and/or use of NXP Semiconductors products in such equipment or applications and therefore such inclusion and/or use is at the customer's own risk.

Applications — Applications that are described herein for any of these products are for illustrative purposes only. NXP Semiconductors makes no representation or warranty that such applications will be suitable for the specified use without further testing or modification.

Customers are responsible for the design and operation of their applications and products using NXP Semiconductors products, and NXP Semiconductors accepts no liability for any assistance with applications or customer product design. It is customer's sole responsibility to determine whether the NXP Semiconductors product is suitable and fit for the customer's applications and products planned, as well as for the planned application and use of customer's third party customer(s). Customers should provide appropriate design and operating safeguards to minimize the risks associated with their applications and products.

NXP Semiconductors does not accept any liability related to any default, damage, costs or problem which is based on any weakness or default in the customer's applications or products, or the application or use by customer's third party customer(s). Customer is responsible for doing all necessary testing for the customer's applications and products using NXP Semiconductors products in order to avoid a default of the applications and the products or of the application or use by customer's third party customer(s). NXP does not accept any liability in this respect.

Limiting values — Stress above one or more limiting values (as defined in the Absolute Maximum Ratings System of IEC 60134) will cause permanent damage to the device. Limiting values are stress ratings only and (proper) operation of the device at these or any other conditions above those given in the Recommended operating conditions section (if present) or the Characteristics sections of this document is not warranted. Constant or repeated exposure to limiting values will permanently and irreversibly affect the quality and reliability of the device.

Terms and conditions of commercial sale — NXP Semiconductors products are sold subject to the general terms and conditions of commercial sale, as published at <http://www.nxp.com/profile/terms>, unless otherwise agreed in a valid written individual agreement. In case an individual agreement is concluded only the terms and conditions of the respective agreement shall apply. NXP Semiconductors hereby expressly objects to applying the customer's general terms and conditions with regard to the purchase of NXP Semiconductors products by customer.

No offer to sell or license — Nothing in this document may be interpreted or construed as an offer to sell products that is open for acceptance or the grant, conveyance or implication of any license under any copyrights, patents or other industrial or intellectual property rights.

Export control — This document as well as the item(s) described herein may be subject to export control regulations. Export might require a prior authorization from national authorities.

Quick reference data — The Quick reference data is an extract of the product data given in the Limiting values and Characteristics sections of this document, and as such is not complete, exhaustive or legally binding.

13.4 Trademarks

Notice: All referenced brands, product names, service names and trademarks are the property of their respective owners.

14. Contact information

For more information, please visit: <http://www.nxp.com>

For sales office addresses, please send an email to: salesaddresses@nxp.com

15. Contents

1	Product profile	1
1.1	General description	1
1.2	Features and benefits	1
1.3	Applications	1
1.4	Quick reference data	1
2	Pinning information	2
3	Ordering information	2
4	Marking	2
5	Limiting values	3
6	Thermal characteristics	3
7	Characteristics	3
8	Test information	8
8.1	Quality information	9
9	Package outline	9
10	Packing information	9
11	Soldering	10
12	Revision history	11
13	Legal information	12
13.1	Data sheet status	12
13.2	Definitions	12
13.3	Disclaimers	12
13.4	Trademarks	13
14	Contact information	13
15	Contents	14

Please be aware that important notices concerning this document and the product(s) described herein, have been included in section 'Legal information'.

© NXP B.V. 2010.

All rights reserved.

For more information, please visit: <http://www.nxp.com>

For sales office addresses, please send an email to: salesaddresses@nxp.com

Date of release: 26 July 2010

Document identifier: BCV62

Компания «Life Electronics» занимается поставками электронных компонентов импортного и отечественного производства от производителей и со складов крупных дистрибьюторов Европы, Америки и Азии.

С конца 2013 года компания активно расширяет линейку поставок компонентов по направлению коаксиальный кабель, кварцевые генераторы и конденсаторы (керамические, пленочные, электролитические), за счёт заключения дистрибьюторских договоров

Мы предлагаем:

- Конкурентоспособные цены и скидки постоянным клиентам.
- Специальные условия для постоянных клиентов.
- Подбор аналогов.
- Поставку компонентов в любых объемах, удовлетворяющих вашим потребностям.
- Приемлемые сроки поставки, возможна ускоренная поставка.
- Доставку товара в любую точку России и стран СНГ.
- Комплексную поставку.
- Работу по проектам и поставку образцов.
- Формирование склада под заказчика.
- Сертификаты соответствия на поставляемую продукцию (по желанию клиента).
- Тестирование поставляемой продукции.
- Поставку компонентов, требующих военную и космическую приемку.
- Входной контроль качества.
- Наличие сертификата ISO.

В составе нашей компании организован Конструкторский отдел, призванный помогать разработчикам, и инженерам.

Конструкторский отдел помогает осуществить:

- Регистрацию проекта у производителя компонентов.
- Техническую поддержку проекта.
- Защиту от снятия компонента с производства.
- Оценку стоимости проекта по компонентам.
- Изготовление тестовой платы монтаж и пусконаладочные работы.



Тел: +7 (812) 336 43 04 (многоканальный)

Email: org@lifeelectronics.ru