

PGR-8800 SERIES (D1000)

Arc-Flash Relay

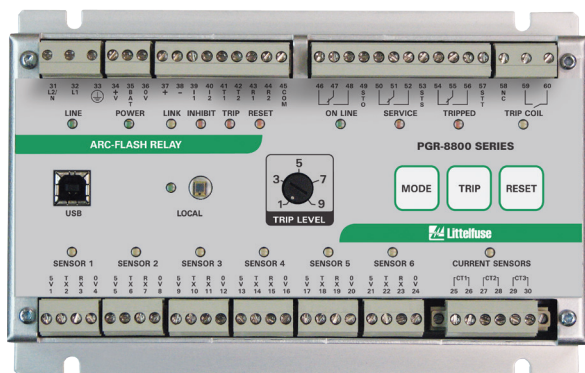

Description

The PGR-8800 is a microprocessor-based relay that limits arc-fault damage by detecting the light from an arc flash and rapidly tripping. Phase-current-transformer inputs are provided for current-constrained arc-flash protection and, when so equipped, a programmable definite-time overcurrent function can be enabled. An optical sensor on the PGR-8800 and adjustable trip level reduce the chance of nuisance tripping by setting a threshold for ambient light. Sensors, inputs, and connections are monitored to ensure fail-safe operation. A secondary solid-state trip circuit provides a redundant trip path. A USB port is used for configuration and access to event logs and graphs.

Simplified Circuit Diagram

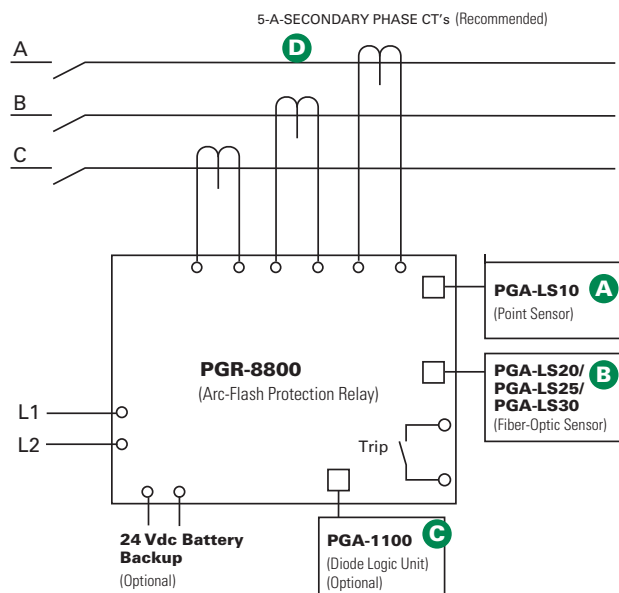

For detailed wiring diagram, see adjacent page.

Ordering Information

ORDERING NUMBER	COMMUNICATIONS
PGR-8800-00 (UL, CE, C-tick)	Multi-unit linking, Modbus® RTU
ACCESSORIES	REQUIREMENT
PGA-LS10 (A1000)	Required*
PGA-LS20 (A2000)/ PGA-LS25 (A2000.0020) PGA-LS30 (A2000.0030)	Required*
PGA-1100 (D1100)	Optional
Current Transformer	Optional

*At least one sensor is required. However, the exact number of sensors for proper coverage depends on the application.

Optical Sensors

The PGR-8800 accepts both PGA-LS10 and PGA-LS20/PGA-LS25/PGA-LS30 optical sensors, designed to collect light over a wide angle and with high sensitivity. For fast fault location, front-panel and sensor LED's indicate sensor health and which sensor detected an arc fault.

Sensor Placement

The PGR-8800 Arc-Flash Relay and sensors are easily installed in retrofit projects and new switchgear with little or no re-configuration. Even elaborate systems with multiple power sources take minutes to configure using the relay's built-in USB interface software.

Generally, it is recommended to mount 1 or 2 sensors per cubicle to cover all horizontal and vertical bus bars, breaker compartments, drawers, and anywhere that there is potential for an arc-fault. Threading a fiber-optic sensor through the cabinets and in areas where point-sensor coverage is uncertain results in complete coverage and an added level of redundancy. Even if policy is to only work on de-energized systems, all maintenance areas should be monitored to prevent potential damage and additional cost. At least one sensor should have visibility of an arc fault if a person blocks the other sensor(s).

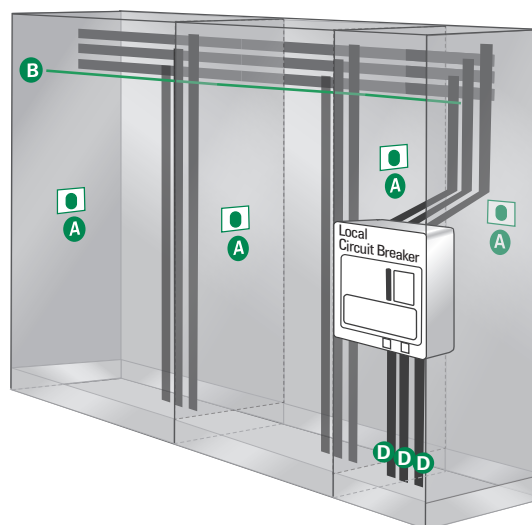

PGR-8800 SERIES (D1000)

Arc-Flash Relay



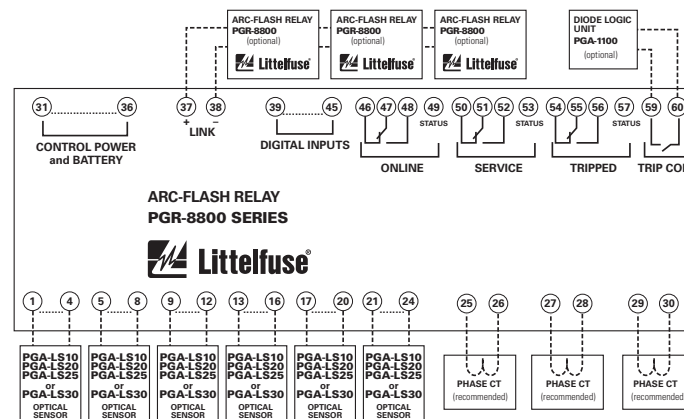

Features & Benefits

FEATURES	BENEFITS
Arc-Flash trip time <1 ms	Limits arc-flash damage and risk of injury
Multiple sensors (up to 24)	Single module can monitor 6 sensors. Up to 4 PGR-8800 units can be linked into one system
Fail-safe system	Continuous monitoring of optical sensors and inputs ensures protection
Redundant trip circuit	Solid-state backup arc-detection circuit adds a second layer of safety
Adjustable light sensitivity	Allows for operation in bright environments and maximum sensitivity in dark environments
LED indication (on unit and each sensor)	18 LEDs provide at-a glance status for module and I/O state
Current detection	Phase-CT inputs provide overcurrent protection and prevent nuisance trips
Optical detection	Point and fiber-optic sensors provide wide detection area with sensor health trip indication
Digital inputs (6)	Two each: remote trip, inhibit, and reset inputs
Service mode	Allows for system test without tripping
Trip coil contact	Solid-state 24-300 Vdc/24-300 Vac IGBT
Indication contacts	Form C and status outputs
USB interface	Data logging and configuration software uses a USB interface with no drivers or software installation
Built-in sensor	Can be used in single-sensor systems, as a seventh sensor, and for calibration
Universal power supply/Battery backup	100-240 Vac, 14-48 Vdc, or 110-250 Vdc supply accepted. Ability to charge and run off an external, user-supplied 24 Vdc battery.
Data logging	On-board event recorder helps with system diagnostics
Modbus	Remotely view measured values, event records & reset trips
Upstream Tripping	Ability to trip upstream device if the local breaker fails to clear the fault

Wiring Diagram



Accessories

- A**  **PGA-LS10 (A1000) Point Sensor**
Line-of-sight light sensor detects an arc as small as 3 kA within a 2-m half-sphere. Sensor health and trip indication. Dimensions: See PGR-8800 Manual
- B**  **PGA-LS20 (A2000)/PGA-LS25 (A2000.0020)/PGA-LS30(A2000.0030) Fiber-Optic Sensor**
360° light sensor for tricky installations with many shadows or to run along bus bars. Sensor health and trip indication. Dimensions: See PGR-8800 Manual
- C**  **PGA-1100 (D1100) Diode Logic Unit**
This module allows multiple PGR-8800 relays to trip the same breaker, for example an upstream or a tie-breaker. Dimensions: **H** 80mm (3.15") **W** 20mm (.79") **D** 70mm (2.76")
- D**  **Current Transformers**
Eliminate nuisance arc-flash trips and use for overcurrent protection.

Specifications

IEEE Device Numbers	Overcurrent (50), Arc Flash (AFD)
Input Voltage	100-240 Vac, 14-48 Vdc, and 110-250 Vdc
Dimensions	H 130 mm (5.2"); W 200 mm (7.9"); D 54 mm (2.2")
Optical Trip Settings	9-25 klux, 800 μs-20 s
Current Trip Setting (A)	Programmable
Indication Contact Mode	Fail-safe
Trip Coil Voltage⁽¹⁾	24-300 Vdc, 24-300 Vac
Trip Coil Contact Mode	Selectable fail-safe or non-fail-safe
Redundant Trip Circuit	Standard feature
Input Monitoring	Standard feature
USB Interface	Standard feature
Trip, Reset, Service Buttons	Standard feature
Expandable System	Link up to 4 PGR-8800 units
Warranty	5 years
Mounting	DIN (with D0050 adapter clips), Surface

NOTE (1) - Contact Littelfuse for trip coil voltages higher than 300 Vdc/Vac.

Littelfuse reserves the right to make product changes, without notice. Material in this document is as accurate as known at the time of publication. Visit Littelfuse.com for the most up-to-date information.

Компания «Life Electronics» занимается поставками электронных компонентов импортного и отечественного производства от производителей и со складов крупных дистрибьюторов Европы, Америки и Азии.

С конца 2013 года компания активно расширяет линейку поставок компонентов по направлению коаксиальный кабель, кварцевые генераторы и конденсаторы (керамические, пленочные, электролитические), за счёт заключения дистрибьюторских договоров

Мы предлагаем:

- Конкурентоспособные цены и скидки постоянным клиентам.
- Специальные условия для постоянных клиентов.
- Подбор аналогов.
- Поставку компонентов в любых объемах, удовлетворяющих вашим потребностям.
- Приемлемые сроки поставки, возможна ускоренная поставка.
- Доставку товара в любую точку России и стран СНГ.
- Комплексную поставку.
- Работу по проектам и поставку образцов.
- Формирование склада под заказчика.
- Сертификаты соответствия на поставляемую продукцию (по желанию клиента).
- Тестирование поставляемой продукции.
- Поставку компонентов, требующих военную и космическую приемку.
- Входной контроль качества.
- Наличие сертификата ISO.

В составе нашей компании организован Конструкторский отдел, призванный помогать разработчикам, и инженерам.

Конструкторский отдел помогает осуществить:

- Регистрацию проекта у производителя компонентов.
- Техническую поддержку проекта.
- Защиту от снятия компонента с производства.
- Оценку стоимости проекта по компонентам.
- Изготовление тестовой платы монтаж и пусконаладочные работы.



Тел: +7 (812) 336 43 04 (многоканальный)

Email: org@lifeelectronics.ru